

GUIDE FOR CD

1) COMPOSITION

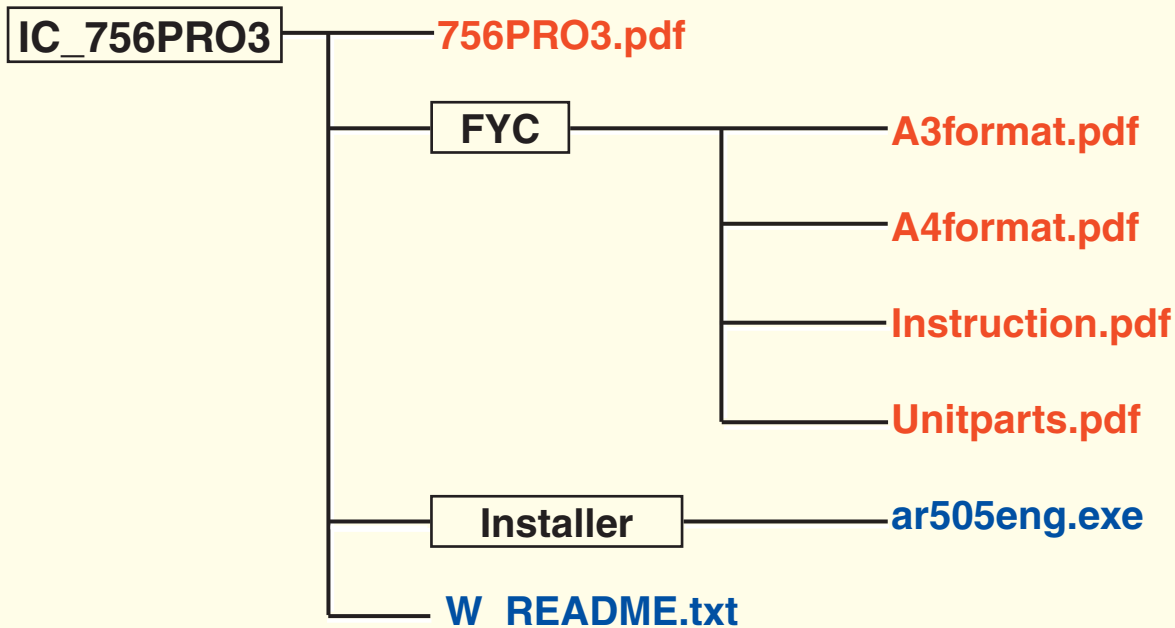

2) DESCRIPTION

756PRO3.pdf

756PRO3.pdf is a service manual for IC-756PROIII and including all service information in this CD. This file is mainly used for viewing on the computer display and checking page order to make printed service manual. Or when you want to find a component, you can find very fast using “FIND” function (except Board layout).

A3format.pdf

A3format.pdf consists of A3 format pages (Board layout, Mechanical parts and disassembly, and etc.) in 756PRO3.pdf. This file is used for printing out A3 format pages.

A4format.pdf

A4format.pdf consists of A4 format pages (Circuit description, Adjustment procedures, Parts list, and etc.) in 756PRO3.pdf. This file is used for printing out A4 format pages.

Instruction.pdf

Instruction.pdf is a instruction manual for IC-756PROIII. This file is exactly same as supplying instruction manual withproduct and consists of all A4 format pages. If you have A4 format printer, you can print out and make brand new instruction manual any time you want. Also this file is very helpful when you want to change or set product conditionfor adjustment or else.

Unitparts.pdf

Unitparts.pdf is assemble unit information for IC-756PROIII. This information for authorized dis-tributor/dealer only. Because we (ICOM INC.) don't sell assemble unit to general.

ar505eng.exe

ar505eng.exe is an installation program of Adobe Acrobat® Reader 5.0 (English version) for Microsoft® Windows® 95/98/Me/NT/2000/XP users.

W_README.txt

W_README.txt is a readme text about this service manual for Windows® user that not installed Acrobat® Reader yet.

=====
Icom, Icom Inc. and Icom logo are registered trademarks of Icom Incorporated (Japan) in the United states, the United Kingdom, Germany, France, Spain, Russia and/or other countries.

Acrobat Reader Copyright © 1987-2002 Adobe Systems Incorporated. All rights reserved.
Adobe, the Adobe logo, Acrobat, and the Acrobat logo are trademarks of Adobe Systems Incorporated.

Microsoft and Windows are registered trademarks of Microsoft Corporation in the U.S.A. and other countries.

Copyright 2004 Icom Inc.
=====



SERVICE MANUAL

HF/50MHz ALL MODE TRANSCEIVER

IC-756PROIII

INTRODUCTION

This service manual describes the latest service information for the **IC-756PROIII** HF/50MHz ALL MODE TRANSCEIVER.

VER.NO.	SYMBOL	VERSION
#32	USA	U.S.A.
#33	EUR	Europe
#34	FRA	France
#35	UK	United Kingdom
#38	ITA	Italy
#39	KOR	Korea
#40	ESP	Spain

To upgrade quality, any electrical or mechanical parts and internal circuits are subject to change without notice or obligation.

DANGER

NEVER connect the transceiver to an AC outlet or to a DC power supply that uses more than 16 V. This will ruin the transceiver.

DO NOT expose the transceiver to rain, snow or any liquids.

DO NOT reverse the polarities of the power supply when connecting the transceiver.

DO NOT apply an RF signal of more than 20 dBm (100 mW) to the antenna connector. This could damage the transceiver's front end.



ORDERING PARTS

Be sure to include the following four points when ordering replacement parts:

1. 10-digit order numbers
2. Component part number and name
3. Equipment model name and unit name
4. Quantity required

<SAMPLE ORDER>

1110000960 S.IC NJM4558M IC-756PROIII MAIN-A UNIT 5 pieces
8810005770 Screw BiH M3×8 ZK IC-756PROIII Top cover 10 pieces
Addresses are provided on the inside back cover for your convenience.

REPAIR NOTES

1. Make sure a problem is internal before disassembling the transceiver.
2. **DO NOT** open the transceiver until the transceiver is disconnected from its power source.
3. **DO NOT** force any of the variable components. Turn them slowly and smoothly.
4. **DO NOT** short any circuits or electronic parts. An insulated tuning tool **MUST** be used for all adjustments.
5. **DO NOT** keep power ON for a long time when the transceiver is defective.
6. **DO NOT** transmit power into a signal generator or a sweep generator.
7. **ALWAYS** connect a 50 dB to 60 dB attenuator between the transceiver and a deviation meter or spectrum analyzer when using such test equipment.
8. **READ** the instructions of test equipment thoroughly before connecting equipment to the transceiver.

Icom, Icom Inc. and **icom** are registered trademarks of Icom Incorporated (Japan) in the United States, the United Kingdom, Germany, France, Spain, Russia and/or other countries.

TABLE OF CONTENTS

SECTION 1	SPECIFICATIONS	
SECTION 2	INSIDE VIEWS	
SECTION 3	CIRCUIT DESCRIPTION	
SECTION 4	ADJUSTMENT PROCEDURES	
SECTION 5	PARTS LIST	
SECTION 6	MECHANICAL PARTS AND DISASSEMBLY	
SECTION 7	SEMI-CONDUCTOR INFORMATION	
SECTION 8	BOARD LAYOUTS	
8 - 1	DISPLAY BOARD8 - 1
8 - 2	MODE BOARD8 - 3
8 - 3	PHONE BOARD8 - 3
8 - 4	KEY BOARD8 - 3
8 - 5	TEN-KEY BOARD8 - 3
8 - 6	PBT BOARD8 - 5
8 - 7	RIT BOARD8 - 5
8 - 8	MIC BOARD8 - 5
8 - 9	MEMORY BOARD8 - 5
8 - 10	MAIN-A UNIT8 - 7
8 - 11	DSP-A BOARD8 - 9
8 - 12	RF-B UNIT8 - 11
8 - 13	BPF-A BOARD8 - 13
8 - 14	PREAMP BOARD8 - 13
8 - 15	PLL UNIT8 - 15
8 - 16	PA UNIT8 - 17
8 - 17	FILTER-A UNIT8 - 19
8 - 18	CTRL-A UNIT8 - 21
8 - 19	TUNER-A BOARD8 - 23
SECTION 9	BLOCK DIAGRAM	
SECTION 10	VOLTAGE DIAGRAMS	
10 - 1	FRONT UNIT	10 - 1
10 - 2	DSP-A BOARD	10 - 3
10 - 3	TUNER-A, MEMORY BOARDS AND CTRL-A UNIT	10 - 5
10 - 4	MAIN-A UNIT	10 - 7
10 - 5	PLL UNIT	10 - 12
10 - 6	PA AND FILTER-A UNITS	10 - 15
10 - 7	BPF-A, PREAMP BOARDS AND RF-B UNIT	10 - 17

SECTION 1 SPECIFICATIONS

■ GENERAL

- Frequency coverage:

Receive	0.030–60.000 MHz*1, *2	
Transmit	1.800–1.999 MHz*2	3.500–3.999 MHz*2
	5.3305, 5.3465, 5.3665, 5.3715, 5.4035 MHz*3	
	7.000–7.300 MHz*2	10.100–10.150 MHz*2
	14.000–14.350 MHz*2	18.068–18.168 MHz*2
	21.000–21.450 MHz*2	24.890–24.990 MHz*2
	28.000–29.700 MHz*2	50.000–54.000 MHz*2

*1 Some frequency bands are not guaranteed.
 *2 Depending on version.
 *3 [USA] only.
- Mode : USB, LSB, CW, RTTY, AM, FM
- Number of memory channels :
101 (99 regular, 2 scan edges)
- Antenna connector : SO-239 × 2 (50 Ω)
phono jack (RCA; 50 Ω)
- Usable temp. range: –10°C to +50°C (14°F to 122°F)
- Frequency stability : Less than ±0.5 ppm from 1 min. after power ON. (–10°C to +50°C; 14°F to 122°F)
- Freq. resolution : 1 Hz
- Power supply requirement:
13.8 V DC ±15% (negative ground)
- Current drain :

Transmit	max. power	23 A
Receive	stand-by	3.0 A (typical)
	max. audio	3.3 A (typical)
- Dimensions : 340(W)×111(H)×285(D) mm (proj. not included) ; 33⅞(W)×43⅞(H)×117⅜(D) in
- Weight (approx.) : 9.6 kg (21 lb 3 oz)
- ACC 1 connector : 8-pin DIN connector
- ACC 2 connector : 7-pin DIN connector
- CI-V connector : 2-conductor 3.5(d) mm (1/8")
- Display : 5-inch (diagonal) TFT color LCD

■ TRANSMITTER

- Output power :

SSB/CW/RTTY/FM	5–100 W
AM	5–40 W
- Modulation system :

SSB	PSN modulation
AM	Low power modulation
FM	Phase modulation
- Spurious emission : Less than –50 dB (HF bands)
Less than –60 dB (50 MHz band)
- Carrier suppression: More than 40 dB
- Unwanted sideband suppression:
More than 55 dB
- ΔTX variable range : ±9.999 kHz
- Mic. connector : 8-pin connector (600 Ω)
- ELE-KEY connector: 3-conductor 6.35(d) mm (1/4")
- KEY connector : 3-conductor 6.35(d) mm (1/4")
- SEND connector : Phono jack (RCA)
- ALC connector : Phono jack (RCA)

■ RECEIVER

- Receive system : Triple-conversion
superheterodyne system
- Intermediate frequencies:

1st IF	64.455 MHz
2nd IF	455 kHz
3rd IF	36 kHz
- Sensitivity :

SSB, CW, RTTY (at 2.4 kHz bandwidth)	
1.8–29.99 MHz*1	0.16 μV (10 dB S/N)
50.0–54.0 MHz*2	0.13 μV (10 dB S/N)
AM (at 6.0 kHz bandwidth)	
0.5–1.799 MHz	13 μV (10 dB S/N)
1.8–29.99 MHz*1	2.0 μV (10 dB S/N)
50.0–54.0 MHz*2	1.0 μV (10 dB S/N)
FM (at 15 kHz bandwidth)	
28.0–29.99 MHz*1	0.5 μV (12 dB SINAD)
50.0–54.0 MHz*2	0.32 μV (12 dB SINAD)

*1 Pre-amp 1 ON *2 Pre-amp 2 ON
- Squelch sensitivity : (Pre-amp OFF)

SSB/CW/RTTY	Less than 5.6 μV
FM	Less than 1.0 μV
- Selectivity :

SSB/RTTY (at 2.4 kHz bandwidth)	
	More than 2.4 kHz/–6 dB
	Less than 3.6 kHz/–60 dB
CW (at 500 Hz bandwidth)	
	More than 500 Hz/–6 dB
	Less than 700 Hz/–60 dB
AM (at 6 kHz bandwidth)	
	More than 6.0 kHz/–6 dB
	Less than 15.0 kHz/–60 dB
FM (at 15 kHz bandwidth)	
	More than 12 kHz/–6 dB
	Less than 20 kHz/–60 dB
- Spurious and image rejection ratio:
More than 70 dB
(except IF through in 50 MHz band)
- RIT variable range : ±9.999 kHz
- Audio output power : More than 2.0 W at 10% distortion
(at 13.8 V DC) with an 8 Ω load
- PHONES connector: 3-conductor 6.35(d) mm (1/4")
- EXT SP connector : 2-conductor 3.5(d) mm (1/8") 8 Ω

■ ANTENNA TUNER

- Matching impedance range:

HF bands	16.7 to 150 Ω unbalanced*1
50 MHz band	20 to 125 Ω unbalanced*2

*1 Less than VSWR 3:1 *2 Less than VSWR 2.5:1
- Minimum operating input power:
8 W
- Tuning accuracy : VSWR 1.5:1 or less
- Insertion loss : Less than 1.0 dB
(after tuning)

All stated specifications are subject to change without notice or obligation.

SECTION 2 INSIDE VIEWS

• TOP VIEW

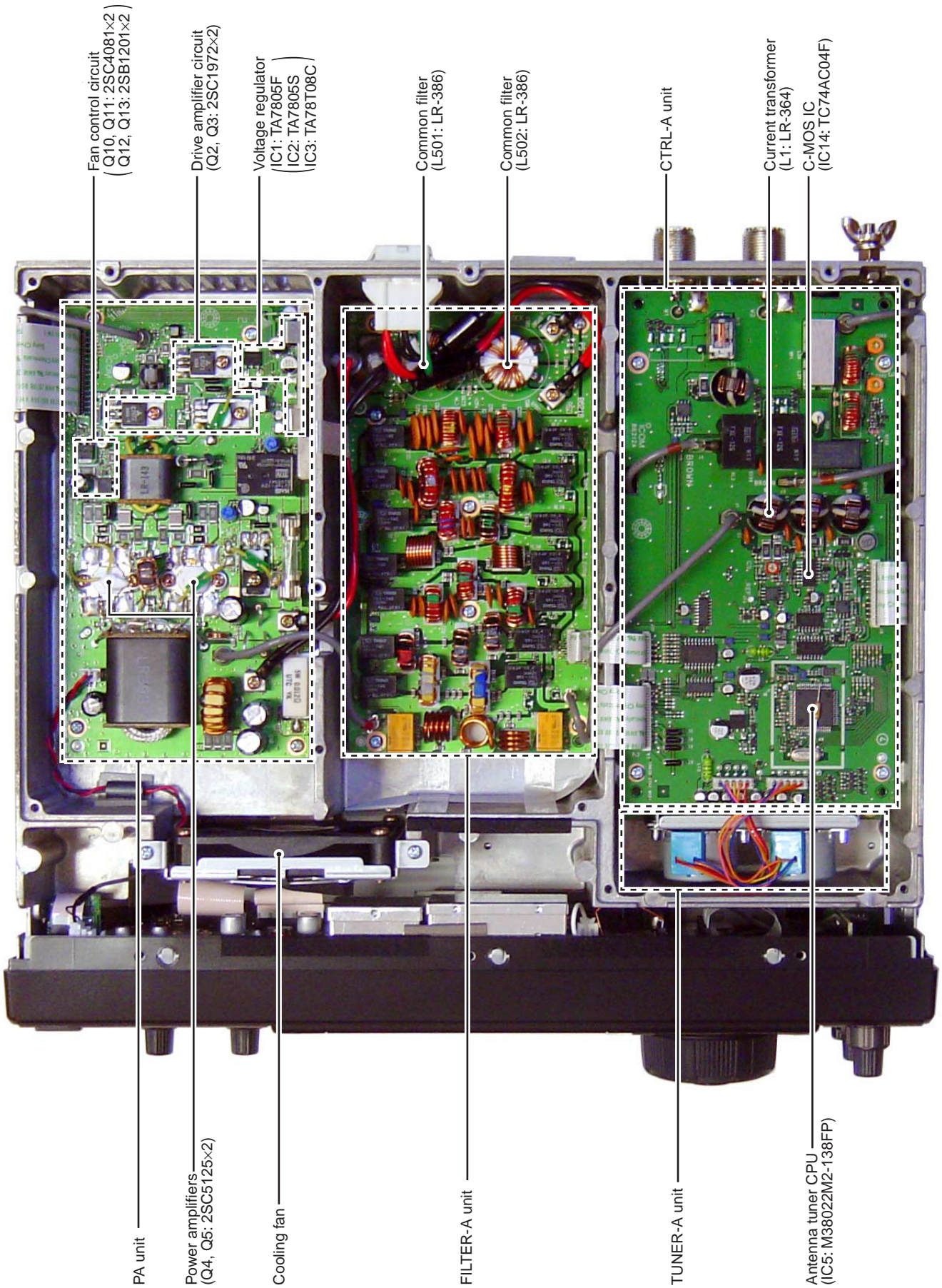

• BOTTOM VIEW

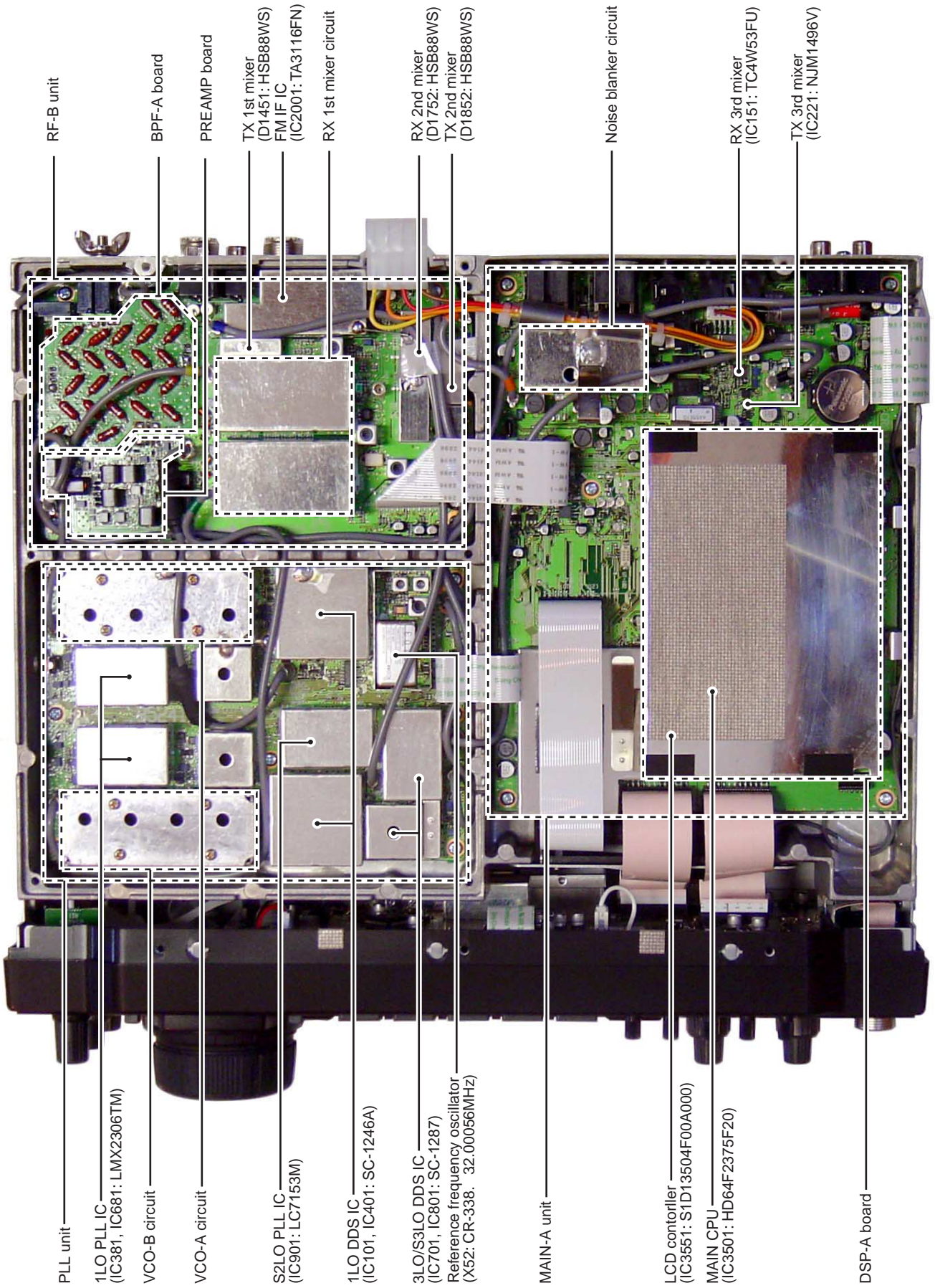

SECTION 3 CIRCUIT DESCRIPTION

3-1 RECEIVER CIRCUIT

3-1-1 RF SWITCHING CIRCUIT (CTRL-A AND RF-B UNITS)

The RF switching circuit leads receive signals to bandpass filters from an antenna connector while receiving. However, the circuit leads the signal from the RF power amplifier to the antenna connector while transmitting.

RF signals from [ANT 1] or [ANT 2] pass through the antenna selector (RL3), transmit/receive switching relays (RL1, RL2, RL4), and low-pass filter (L27, L28, C63–C66, C105), and are then applied to the RF-B unit via J101 (RF-B unit).

The signals from the CTRL-A unit either bypass or pass through the 6 dB (RF-B unit, R102, R106, R111, RL102) and/or 12 dB (RF-B unit, R112, R113, R114, RL103) attenuators via the antenna selector (RL101). By selecting the attenuators, 0 (bypass), 6, 12 and 18 dB attenuations are obtained. The signals are then applied to the RF filters.

When the [RX ANT] is selected, the RF signals are passed through the low-pass filter (RF-B unit, L101, L102, C101–C105), then applied to the antenna selector (RF-B unit, RL101).

3-1-2 RF BANDPASS FILTER CIRCUIT (RF-B UNIT AND BPF-A BOARD)

RF bandpass filters pass only the desired band signals and suppress any undesired band signals. The RF circuit has 11 bandpass filters and 1 low-pass filter.

(1) 0.03–1.6 MHz (RF-B UNIT)

The signals pass through the low-pass filter (L801–L802, C802, C805–C807), attenuator (R801–R803), and are then applied to the RF amplifiers (Q1001, Q1002).

(2) 1.6–60 MHz (RF-B UNIT AND BPF-A BOARD)

The signals pass through the band switch (D104) and high-pass filter (L251–L253, C251, C252, C271–C274) to suppress excessively strong signals below 1.6 MHz. The filtered signals are applied to one of 11 bandpass filters on the table at right above, and then applied to or bypassed the pre-amplifier circuit.

• Used RF filter

Band	Control signal	Input diode	Band	Control signal	Input diode
0.03–1.6 MHz	B0	D801	11–15 MHz	B7	D551
1.6–2 MHz	B1	*D3201	15–22 MHz	B8	D602
2–3 MHz	B2	*D3301	22–30 MHz	B9	D651
3–4 MHz	B3	*D3401	30–50 MHz	B10W	D701
4–6 MHz	B4	*D3501	50–54 MHz	B10	D751
6–8 MHz	B5	*D3601	54–60 MHz	B10W	D701
8–11 MHz	B6	D501			

*: On the BPF-A board

3-1-3 PRE-AMPLIFIER CIRCUITS (PRIAMP BOARD)

The IC-756PROIII has 2 gain levels of pre-amplifier circuits. One has 10 dB gain for the 1.8–21 MHz bands and the other one has 16 dB gain for the upper 24 MHz bands.

When the [P.AMP] switch is set to [P.AMP 1] or [P.AMP 2], the signals are applied to the pre-amplifier 1 (Q4201, Q4202) or pre-amplifier 2 (Q4302) circuit, respectively. Pre-amplified or bypassed signals are applied to the RF amplifier circuits (RF-B unit; Q1001, Q1002 or Q1201, Q1202).

3-1-4 RF AMPLIFIER AND 1ST MIXER CIRCUITS (RF-B UNIT)

The 1st mixer circuit mixes the receive signals with the 1st LO signal to convert the receive signal frequencies into a 64.455 MHz 1st IF signal. The IC-756PROIII has two 1st mixer circuits for the dualwatch function.

The signals from the pre-amplifier circuit, or signals which bypass the pre-amplifiers, are divided at L902, L903. Each signal is applied to a 60 MHz cut-off low-pass filter, RF amplifier (Q1001, Q1002 for sub readout or Q1201, Q1202 for main readout) and then to a 1st mixer (Q1003–Q1006 sub readout or Q1203–Q1206 for main readout) to convert the frequency into the 64.455 MHz 1st IF signal.

Each 1st LO signal (64.4850–124.4550 MHz) from the PLL unit via J1101 or J1301. The LO signals are amplified at the LO amplifier (Q1101; sub or Q1301; main), filtered by a low-pass filter, and then applied to each 1st mixer.

• Receiver construction

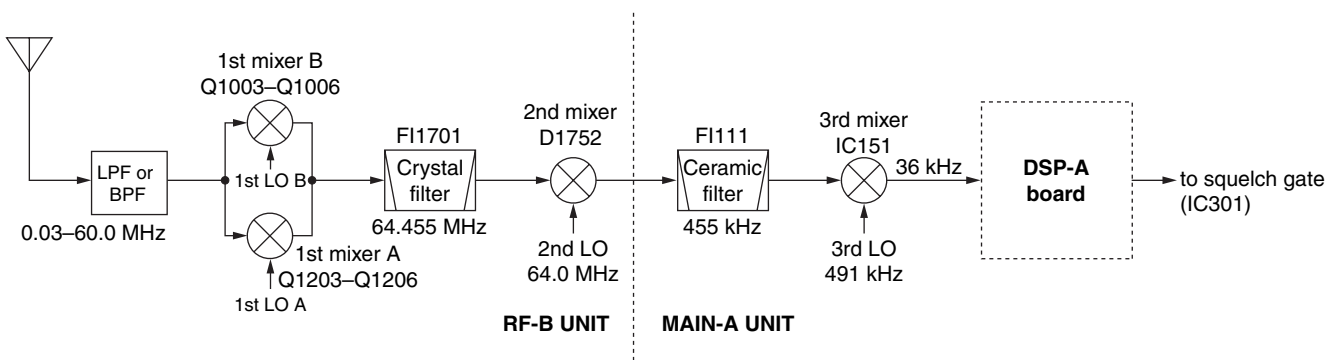

3-1-5 1ST IF CIRCUIT (RF-B UNIT)

The 1st IF circuit filters and amplifies the 1st IF signal. The 1st IF signal combined at L1018 and is then applied to a MCF (Monolithic Crystal Filter; F11701) to suppress out-of-band signals.

The 1st IF signal level is adjusted at the PIN attenuators (D1001, D1003, D1004; sub or D1201, D1203, D1204 for main) controlled by the [BAL] controller for the dualwatch function. The signal is applied to the 1st IF amplifier (Q1008; sub or Q1208; main) and then combined at L1018.

The combined signal is pass through the MCFs (F11701) and is then applied to the 1st IF amplifier (Q1751). The amplified signal is then applied to the 2nd mixer circuit.

3-1-6 2ND MIXER CIRCUIT (RF-B UNIT)

The 2nd mixer circuit mixes the 1st IF signal and 2nd LO signal (64.00 MHz) for conversion into the 2nd IF signal.

The 1st IF signal from the 1st IF amplifier (Q1751) is converted into a 455 kHz 2nd IF signal at the 2nd mixer circuit (D1752).

The 2nd IF signal is applied to the noise blanker gate (MAIN-A unit) via the J1851.

3-1-7 NOISE BLANKER CIRCUIT (MAIN-A UNIT)

The noise blanker circuit detects pulse-type noise, and turns OFF the signal line when the noise appears.

The 2nd IF signal from the RF-B unit is applied to the noise blanker gate (D113, D114).

A portion of the 2nd IF signal is amplified at the noise amplifiers (Q271–Q273, Q279), and is then detected at the noise detector (D271) to convert the noise components to DC voltages.

The signal is then applied to the noise blanker switch (Q276, Q278). At the moment the detected voltage exceeds Q276's threshold level, Q278 outputs a blanking signal to close the noise blanker gate (D113, D114). The PLL unlock signal are also applied to Q278, to control the noise blanker gate.

Some DC voltage from the noise detector circuit is fed back to the noise amplifiers (Q271, Q272) via the DC amplifiers (Q274, Q275). The DC amplifiers function as an AGC circuit to reduce average noise. Therefore, the noise blanker function shuts off pulse-type noise only.

3-1-8 2ND IF CIRCUIT (MAIN-A UNIT)

The 2nd IF circuit amplifies and filters the 2nd IF signal, and applies the 2nd IF signal to the 3rd mixer circuit.

The 2nd IF signal from the noise blanker gate (D113, D114) is amplified at the 2nd IF amplifier (Q141) and passed through the ceramic filter (F1111). The filtered signal is applied to the 3rd mixer circuit.

3-1-9 3RD MIXER AND 3RD IF CIRCUITS (MAIN-A UNIT)

The 3rd mixer circuit mixes the 2nd IF signal and the 3rd LO signal to obtain the 3rd IF (36 kHz) signal.

The 2nd IF signal from the ceramic filter (F1111) is applied to the 3rd mixer circuit (IC151, pin 1). The 3rd LO signal from the PLL unit is applied to the 3rd mixer (IC151, pin 5). The 3rd IF signal is output from pin 6.

The 3rd IF signal is passed through the low-pass filter (IC201a) and amplified at the 3rd IF amplifier (IC201b). The amplified signal is then applied to the DSP-A board via J201 (pin 27) as DRIF signal.

3-1-10 DSP RECEIVER CIRCUIT (DSP-A BOARD)

The DSP (Digital Signal Processor) circuit enables digital IF filter, digital noise reduction, digital PSN (Phase Shift Network)/Low Power/Phase demodulation, digital automatic notch, and etc.

The 36 kHz 3rd IF signal from the 3rd IF amplifier (MAIN-A unit, IC201b) is amplified at the differential amplifiers (IC2301a/b) after being passed through the T/R switch (IC2291), and is then applied to the A/D converter (IC2321).

• DSP receiver circuit

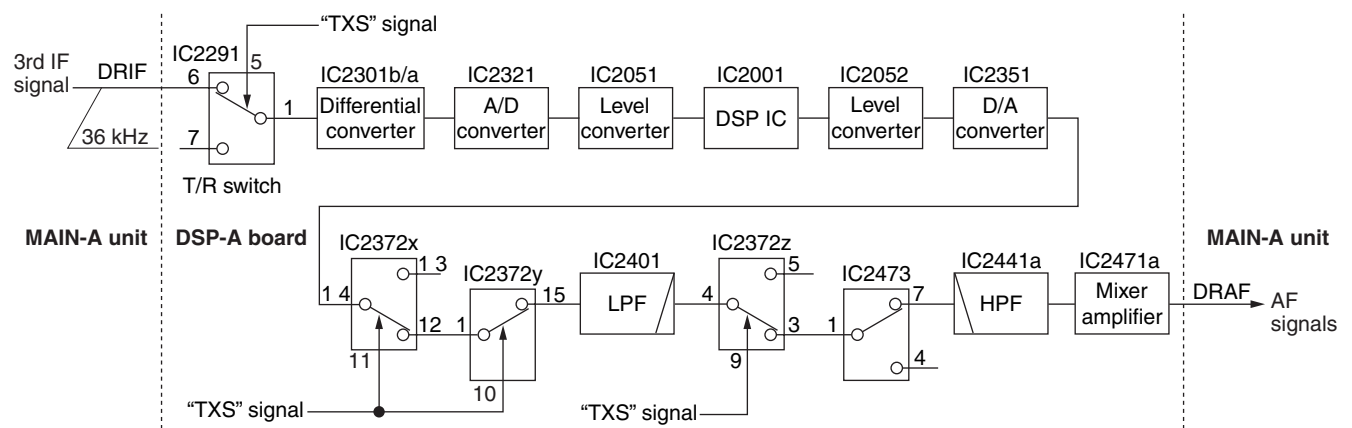

The converted signal is changed from a 5 V level signal to a 3.3 V signal in the level converter (IC2051), and is then applied to the DSP IC (IC2001) for 36 kHz digital IF filter, demodulation, automatic notch and noise reduction, etc. The output signal from the DSP IC (IC2001) is changed from a 3.3 V level signal to a 5 V level signal in the level converter (IC2502), and is applied to the D/A converter (IC2351) to convert into the analog audio signals.

The converted audio signals are passed through the active filter (IC2371a), AF amplifier (IC2371b), analog switches (IC2372, pins 13, 14 and pins 1, 15) then applied to the low-pass filter (IC2401, pins 5, 11). The filtered signals are passed through the analog switches (IC2372, pins 3, 4 and IC2473, pins 1, 7), high-pass filter (IC2441A) and mixer amplifier (IC2471A), and then applied to the MAIN-A unit via J2001 (pin 13) as the DRAF signal.

3-1-11 TWIN PBT CIRCUIT (DSP-A BOARD)

General PBT (Passband Tuning) circuit shifts the center frequency of IF signal to electronically narrow the passband width. The IC-756PROIII uses the DSP circuit for the digital PBT function and actually shifts the both lower and higher passbands of 3rd IF filter within ± 1.8 kHz.

The twin PBT circuit in DSP IC (IC2001) controlled by the [TWIN PBT] controller adjusts the 3rd IF passband width and rejects interference.

3-1-12 AGC CIRCUIT (DSP-A BOARD)

The AGC (Automatic Gain Control) circuit reduces IF amplifier gain and attenuates IF signal to keep the audio output at a constant level.

The receiver gain is determined by the voltage on the AGC line (IC2461, pin 4). The D/A converter (IC2461) for AGC supplies control voltage to the AGC line and sets the receiver gain with the [RF/SQL] control.

The 3rd IF signal from the level converter (IC2051) is detected at the AGC detector section in DSP IC (IC2001), and is applied to the D/A converter for AGC via the level converter (IC2052). The AGC voltage is amplified at the buffer amplifier (IC2471b), and is then applied to the MAIN-A unit via J2001 (pin 16) to control the AGC line.

When receiving strong signals, the AGC voltage decreases via the buffer amplifier (IC2471b). As the AGC voltage is used for the bias voltage of the IF amplifier (RF-B unit; Q1751), and IF amplifier gain is decreased.

3-1-13 S-METER CIRCUIT (MAIN-A UNIT)

The S-meter circuit indicates the relative received signal strength while receiving by utilizing the AGC voltage which changes depending on the received signal strength.

A portion of the AGC bias voltage from the DSP-A board is applied to the differential amplifier (IC101a, pin 2) where the difference between the AGC and reference voltage is detected.

The detected voltage is passed through the analog switch (IC3631, pins 12, 14) as the SML signal and applied to the main CPU (IC3501, pin 108) to activate the S/Rf meter via the sub CPU (DISPLAY board, IC401).

3-1-14 SQUELCH CIRCUIT (MAIN-A UNIT)

The squelch circuit mutes audio output when the S-meter signal is lower than the [RF/SQL] setting level.

The S-meter signal is applied to the main CPU (IC3501, pin 108) and is compared with the threshold level set by the [RF/SQL] control. The [RF/SQL] setting signal is applied to the main CPU via the sub CPU (DISPLAY board; IC401, pin 91). The main CPU analyzes the compared signal and outputs control signal to the squelch gate (IC301, pin 5) via the interface IC (IC3653, pin 19) to open or close the squelch as the SQLS signal.

3-1-15 AF AMPLIFIER CIRCUIT (MAIN-A UNIT)

The AF amplifier amplifies the audio signals to a suitable driving level for the speaker.

The AF signals (DRAF) from the DSP-A board are passed through the squelch gate (IC301, pins 1, 7) and amplified at the AF amplifier section of IC311 (pins 2, 4), and volume is controlled by the AFGV signal at the VCA section (pins 7 –9). The volume controlled AF signals are passed through the AF mute gate (IC331, pins 1, 7), then applied to the AF power amplifier (IC332, pins 1, 4).

The amplified audio signals are passed through the SP mute switch (RL351) and [EXT SP] jack then applied to the internal speaker when no plug is connected to the jack.

The AF mute gate is controlled by the [AF] control via the sub and main CPUs.

When headphones are connected, the SP mute signal from the main CPU (IC3501, pin 56) is applied to the SP mute switch (RL351) via the BUS driver (IC3654, pins 8, 13) as the SPS signal.

• AF amplifier circuit

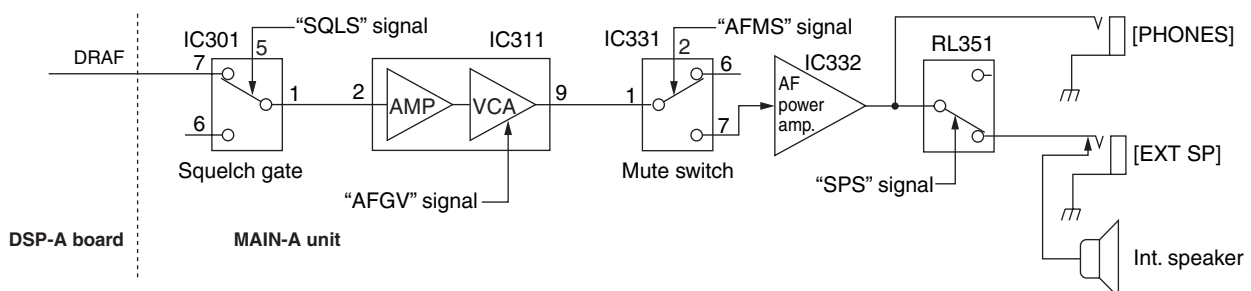

3-2 TRANSMITTER CIRCUITS

3-2-1 MICROPHONE AMPLIFIER CIRCUIT (MAIN-A UNIT)

The microphone amplifier circuit amplifies microphone audio signals to a level needed for the DSP circuit.

Audio signals from the [MIC] connector (MIC board; J1, pin 1) are amplified at the audio amplifier section in IC451 (pins 21, 22) via the analog switch (IC3002, pins 12, 14), then applied to the buffer amplifier section (IC451, pin 5) and VCA section. The gain controlled signals are output from (IC451, pin 9) and passed through the analog switch (IC3005, pins 12, 14) and then applied to the DSP circuit via J201 (pin 15) as the DTAF signal.

The VCA section in IC451 (pin 9) controls microphone input gain according to the [MIC GAIN] control level using the MIGV signal coming from the main CPU via the I/O expander (IC3751, pin 4).

3-2-2 VOX CIRCUIT (MAIN-A UNIT)

The VOX (Voice-Operated Transmission) circuit sets transmitting conditions according to voice input.

A portion of the audio signals from the VCA section (IC451, pin 9) is applied to the AF amplifier (IC3004b, pins 6, 7), and then applied to the main CPU (IC3501, pin 106) after passing through the analog switch (IC362, pins 1, 6) as the VOXL signal.

The VOGV signal is applied to the VCA section in IC3003 (pin 8) from the main CPU via the I/O expander (IC3751, pin 9) to adjust VOX actionable sensitivity. This is controlled by the VOX gain set in the VOX SET mode.

3-2-3 DSP TRANSMITTER CIRCUIT (DSP-A BOARD)

The microphone audio signals from the MAIN-A unit via the DTAF line are applied to the analog switch (IC2201, pin 4) and output from pin 3 or 5 to the each modulation circuits.

(1) When SSB mode

The audio signals from the analog switch (IC2201, pin 5) are amplified at the limiter amplifier (IC2281b) and applied to the low-pass filter (IC2281c/d) to limit the transmit passband width.

The filtered signals are then applied to the differential amplifiers (IC2301a/b) via the analog switch (IC2201, pins 12, 14) and T/R switch (IC2291, pins 1, 7).

(2) When FM/AM modes

The audio signals from the analog switch (IC2201, pin 3) are applied to the modulation adjustment pots (R2227: FM mode, R2229: AM mode) via the limiter amplifier, pre-emphasis circuit (only FM mode) and splatter filter consist of IC2211. The level adjusted signals are applied to the differential amplifiers (IC2301a/b) after being passed through the analog switch (IC2201, pins 1, 2, 13–15) and T/R switch (IC2291 pins 1, 7). The pre-emphasis circuit is cancelled by Q2201, Q2202, Q2211 on AM mode.

The amplified signals at the differential amplifiers (IC2301a/b) are applied to the A/D converter (IC2321 pins 4, 5). The converted signals are changed from 5 V level signals to 3.3 V level signals in the level converter (IC2051).

The converted signals are applied to the DSP IC (IC2001) and modulated at the DSP IC to produce the 36 kHz transmitter IF signal. The modulated IF signal from the DSP IC is changed from a 3.3 V signal to a 5 V signal in the level converter (IC2052), and is applied to the D/A converter (IC2351) to convert into the analog IF signal.

The converted IF signal is passed through the active filter (IC2371a), buffer amplifier (IC2371b), analog switch (IC2372, pins 12, 14) then applied to the low-pass filter (IC2381c/d). The filtered signal is applied to the MAIN-A unit via J2001 (pin 29) as the DTIF signal.

When SSB or RTTY mode, a portion of the filtered IF signal from the low-pass filter (IC2381c/d) is amplified at the IF and buffer amplifiers (IC2381a/b) and is applied to the transmit monitor circuit for the monitor function.

• DSP Transmitter circuit

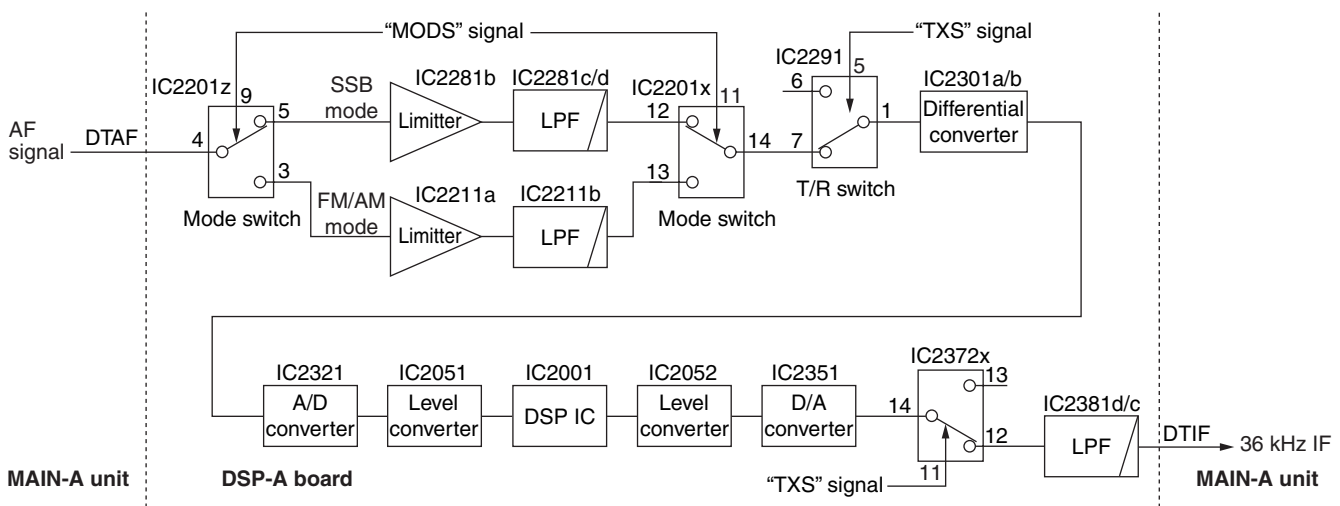

3-2-4 SPEECH COMPRESSOR CIRCUIT (DSP-A BOARD)

The speech compressor compresses the transmitter audio input signals to increase the average output level (average talk power).

When the speech compressor function is ON, the level shifted signal from the level converter (IC2051) is applied to the DSP IC (IC2001) and compressed at the DSP IC to obtain an average audio level.

At the same time, the compressed signals are modulated at the DSP IC and applied to the level converter (IC2052).

3-2-5 IF AMPLIFIER AND MIXER CIRCUITS (MAIN-A AND RF-B UNITS)

The modulated 3rd IF signal from the DSP-A board (DTIF: 36 kHz) is applied to the 3rd mixer circuit (MAIN-A unit; IC221, pin 1). The applied 3rd IF signal is mixed with the 3rd LO signal from the DDS circuit (PLL unit; IC701) to produce a 455 kHz 2nd IF signal.

The 2nd IF signal is output from (MAIN-A; IC221, pin 6) and amplified at the IF amplifier (MAIN-A unit; Q241). The amplified signal is passed through the ceramic bandpass filter (MAIN-A unit; FI131: FM/AM modes, FI133: other modes) for unwanted signals are suppressed. The filtered 2nd IF signal is amplified at IF amplifier (MAIN-A unit; Q261) and applied to the 2nd mixer circuit on the RF-B unit via J101 (MAIN-A unit).

The 2nd IF signal is mixed with the 64 MHz 2nd LO signal, coming from the PLL unit, at the 2nd mixer circuit (RF-B unit; D1852) to obtain a 64.455 MHz 1st IF signal. The 1st IF signal is passed through a MCFs (RF-B unit; FI1701) to cut-off the undesired signals then amplified at the IF amplifier (RF-B unit; Q1551) via the T/R switch (RF-B unit; D1551). The amplified 1st IF signal is applied to the 1st IF mixer circuit (RF-B unit; D1451).

The operating (transmitting) frequency is produced at the 1st IF mixer circuit (RF-B unit; D1451) by mixing the 1st IF and 1st LO signals. The mixed signal is then applied to the RF circuit.

3-2-6 RF CIRCUIT (RF-B AND PA UNITS)

The RF circuit amplifies operating (transmitting) frequency to obtain 100 W of RF output.

The signal from the 1st IF mixer (RF-B unit; D451) is passed through the low-pass filter (RF-B unit; L1402, L1403, C1405–C1409) and amplified at the RF amplifier (RF-B unit; IC1401). The amplified signal is amplified again at the wide-band YGR amplifier (RF-B unit, IC201) after passing through one of 10 bandpass (Refer to page 3-1 for bandpass filters used) and high-pass filters, and is then applied to the PA unit via J201 (RF-B unit).

The signal applied from the RF-B unit is amplified at the pre-drive (Q1), drive (Q2, Q3) and power amplifiers (Q4, Q5) in sequence to obtain a stable 100 W of RF output power. The amplified signal is applied to one of 8 low-pass filters in the FILTER-A unit.

3-2-7 LOW-PASS FILTER CIRCUIT (FILTER-A UNIT)

The low-pass filter circuit contains 8 Chebyshev low-pass filters to suppress the higher harmonic components.

The amplified signal from the PA unit is applied to one of 8 low-pass filters, which is selected by the I/O expander (CTRL-A unit, IC11) via the buffer amplifier (CTRL-A unit; IC12).

The filtered signal is then applied to one of 2 antenna connectors via the CTRL-A unit.

3-2-8 ALC CIRCUIT (MAIN-A UNIT)

The ALC (Automatic Level Control) circuit controls the gain of IF amplifiers in order for the transceiver to output a constant RF power set by the [RF POWER] control even when the supplied voltage shifts, and etc.

The RF power level is detected at one of the APC detector circuits (CTRL-A unit; D2) to be converted into DC voltage and applied to the MAIN-A unit as the FORV signal.

The FORV signal from the CTRL-A unit is applied to the comparator (IC551b, pins 6, 7). The POCV signal, controlled by the [RF POWER] control via the I/O expander (IC3751, pin 5), is also applied to the other input (IC551b, pin 5) for reference. The compared signal is output from pin 7 and applied to the IF amplifiers in the MAIN-A (Q261) and RF-B (Q1551) units to control amplifying gain.

• Transmitter construction

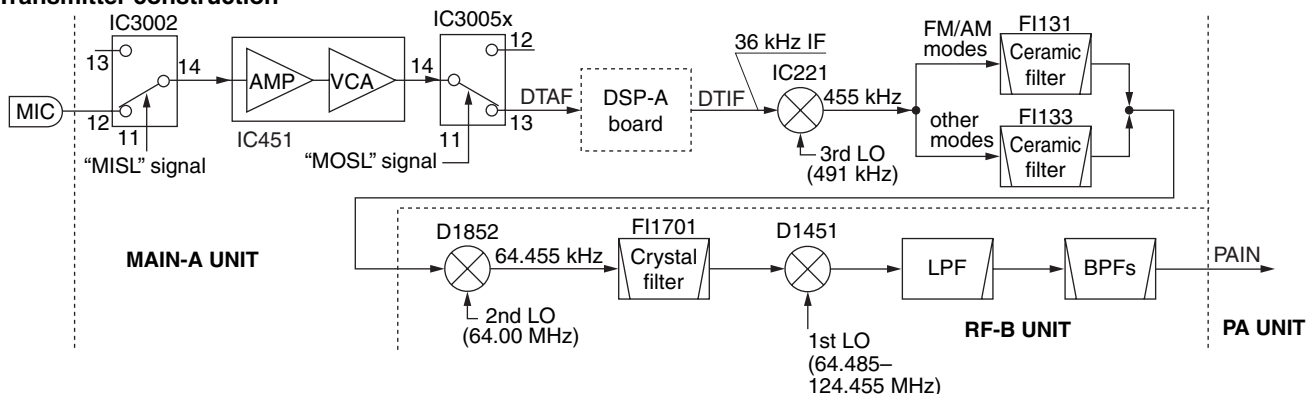

When the FORV signal exceeds the POCV voltage, ALC bias voltage from the comparator (IC551b) controls the IF amplifiers (Q261). This adjusts the output power to a specified level from the [RF POWER] control until the FORV and POCV voltages are equalized.

In AM mode, the comparator operates as an averaging ALC amplifier. Q502 turns ON and the POCV voltage is shifted for 40 W AM output power (maximum) through R510.

The ALC bias voltage is also applied to the ALC meter amplifier (IC551a, pins 1, 2) to obtain an ALC meter signal (ALCL). The amplified signal is passed through the analog switch (IC 3631, pins 13, 14) and applied to the main CPU (IC3501, pin 108) to drive the S/RF meter via the sub CPU (IC401) on the DISPLAY board.

An external ALC input from the [ALC] jack or [ACC] sockets is applied to the buffer amplifier (Q521). External ALC operation is identical to that of the internal ALC.

The FORV signal is also applied to the power meter amplifier (IC571a, pins 1, 3). The amplified signal is passed through the analog switch (IC3631, pins 1, 15) as an FORL signal and applied to the main CPU (IC3501, pin 109) to drive the S/RF meter when the power meter is selected.

3-2-9 APC CIRCUIT (MAIN-A UNIT)

The APC (Automatic Power Control) circuit protects the power amplifiers on the PA unit from high SWR and excessive current.

The reflected wave signal appears and increases when the connected antenna is mismatched to 50 Ω . The APC detector circuit (CTRL-A unit; D1 and L1) detects the reflected signal, and applies it to the APC circuit (IC551c, pins 9, 8) as REFV signal.

When the REFV signal level increases, the APC circuit decreases the ALC voltage to activate the APC.

For the current APC, the power transistor current is obtained by detecting the voltages (ICH and ICL) which appear at both terminals of the current detector (PA unit; R28). The detected voltages are applied to the differential amplifier (IC551d, pins 12–14). When the current of transistors is increased, the amplifier controls the ALC line to prevent excessive current flow.

A portion of the REFV signal is applied to the SWR meter amplifier (IC571b, pins 5, 7). The amplified signal is passed through the analog switch (IC3631, pins 3, 4) as an REFL signal and applied to the main CPU (IC3501, pin 110) to drive the S/RF meter when the SWR meter is selected.

3-2-10 TEMPERATURE PROTECTION CIRCUIT (PA UNIT)

The cooling fan (CHASSIS; MF1) is activated while transmitting or when the temperature of the power amplifier exceeds the preset value. The temperature protection circuit consists of Q10–Q13 and R50.

While transmitting, Q10 and Q12 are turned ON, and provide a voltage to the cooling fan to rotate at medium speed.

The thermistor (R50) detects the temperature of the final amplifier (Q5), and activates Q11 and Q13 to accelerate the cooling fan when the detected temperature exceeds 70°C (158°F). The cooling fan rotates at high speed at 80°C (176°F) or more.

The thermistor keeps the cooling fan rotating even while receiving until the Q5 temperature drops to 60°C (140°F) or below.

3-2-11 MONITOR CIRCUIT (DSP-A BOARD AND MAIN-A UNIT)

The microphone audio signals can be monitored to check voice characteristics.

(1) When FM/AM modes (MAIN-A UNIT)

A portion of the microphone audio signals from the VCA section (IC451; pins 9, 22) are applied to the analog switch (IC361; pins 1, 7). The selected audio signals are applied to IC371 (pin 2), and the output signals from pin 9 are applied to the AF amplifier circuit (IC311, pin 2, 9).

(2) When SSB/RTTY modes (DSP-A BOARD)

A portion of the transmit IF signal from the low-pass filter (IC2381c/d) is amplified at the IF (IC2381b) and buffer (IC2381a) amplifiers, and applied to the digital mixer circuit (IC2302). The applied signal is mixed with a 36 kHz LO signal from the D/A converter (IC2342) to demodulate into the AF signals. The demodulated signals are passed through the buffer amplifier (IC2381a), low-pass filter (IC2441b/c) and AF amplifier (IC2441d), and then applied to the MAIN-A unit via J2001 (pin 19) as the DMAF signal.

The DMAF signal from the DSP-A board is amplified at the ALC amplifier (MAIN-A unit; IC372, pins 1, 13) and applied to the VCA section of IC371 (MAIN-A unit; pins 7, 9). The volume controlled AF signals is applied to the AF amplifier circuit (MAIN-A unit; IC311, pins 2, 9).

3-3 PLL CIRCUITS

3-3-1 GENERAL

The PLL unit generates a pair of 1st LO frequencies (64.485–124.455 MHz) for dualwatch and spectrum scope functions; a 2nd LO frequency (64 MHz), 3rd LO frequency (491 kHz) and sweep LO frequency for the spectrum scope function.

The 1st LO PLLs adopt a mixer-less dual loop PLL system and has 4 VCO circuits. The LOs, except the 2nd, use DDSs while the 2nd LO uses the fixed frequency of the crystal oscillator.

3-3-2 1ST LO PLL CIRCUIT

The 1st LO PLLs contain a main and reference loop as a dual loop system. Both PLLs have equivalent circuits— this manual describes only the 1st LO PLL A circuit.

The reference loop generates a 10.747 to 10.865 MHz frequency using a DDS circuit, and the main loop generates a 64.485 to 124.455 MHz frequency using the reference loop frequency.

(1) REFERENCE LOOP PLL

The oscillated signal at the reference VCO (Q151, D151) is amplified at the buffer amplifiers (Q102, Q152) and is then applied to the DDS IC (IC101, pin 46). The signal is then divided and detected on phase with the DDS generated frequency.

The detected signal output from the DDS IC (IC101, pin 56) is converted into DC voltage (lock voltage) at the loop filter (R135–R137, C121, C151) and then fed back to the reference VCO circuit (Q151, D151).

(2) MAIN LOOP PLL

The oscillated signal at one of the main loop VCOs (Q201, D201, D202), (Q221, D221, D222), (Q251, D251–D254) and (Q271, D271–D274) is amplified at the buffer amplifiers (Q301, IC320) and is then applied to the PLL IC (IC381, pin 6) via the low-pass filter (L303, C304–C307). The signal is then divided and detected on phase with the reference loop output frequency.

The detected signal output from the PLL IC (IC381; pin 2) is converted into a DC voltage (lock voltage) at the loop filter and then fed back to one of the VCO circuits (Q201, D201, D202), (Q221, D221, D222), (Q251, D251–D254) and (Q271, D271–D274).

The oscillated signal is amplified at the buffer amplifiers (Q301, IC320) and then applied to the RF-B unit as a 1st LO A signal after being passed through the low-pass filters (L303, C304–C307 and L351–L353, C351–C356) and high-pass filter (L354, C358–C360) and mute circuit (D361).

3-3-3 2ND LO AND REFERENCE OSCILLATOR CIRCUITS

The reference oscillator (X52, Q51) generates a 32.0 MHz frequency for the 4 DDS circuits as a system clock and for the LO output. The oscillated signal is doubled at the doubler circuit (Q71, Q81) and the 64.0 MHz frequency is picked up at the double tuned filter (L81, L82). The 64.0 MHz signal is applied to the RF-B unit as a 2nd LO signal.

3-3-4 3RD LO CIRCUIT

The DDS IC (IC701) generates a 10-bit digital signal using the 32 MHz system clock. The digital signal is converted into an analog wave signal at the D/A converter (R701–R720). The converted analog wave is passed through the bandpass filter (L702, L703, C709–C713) and then applied to the MAIN-A unit as the 3rd LO signal.

3-3-5 MARKER CIRCUIT

The divided signal at the DDS circuit (IC101) is used for the marker signals with the IC-756PROIII.

The reference signal for the DDS circuit (32.0 MHz) is divided to produce an acceptable frequency signal, 16 MHz, with the programmable divider then divided again by 160 to obtain 100 kHz cycle square-wave signals.

The generated marker signals are output from pin 66 of the DDS IC (IC101), and are then applied to the RF-B unit via the mute switch (IC192) and J851 as the MKR signal.

• PLL CIRCUIT

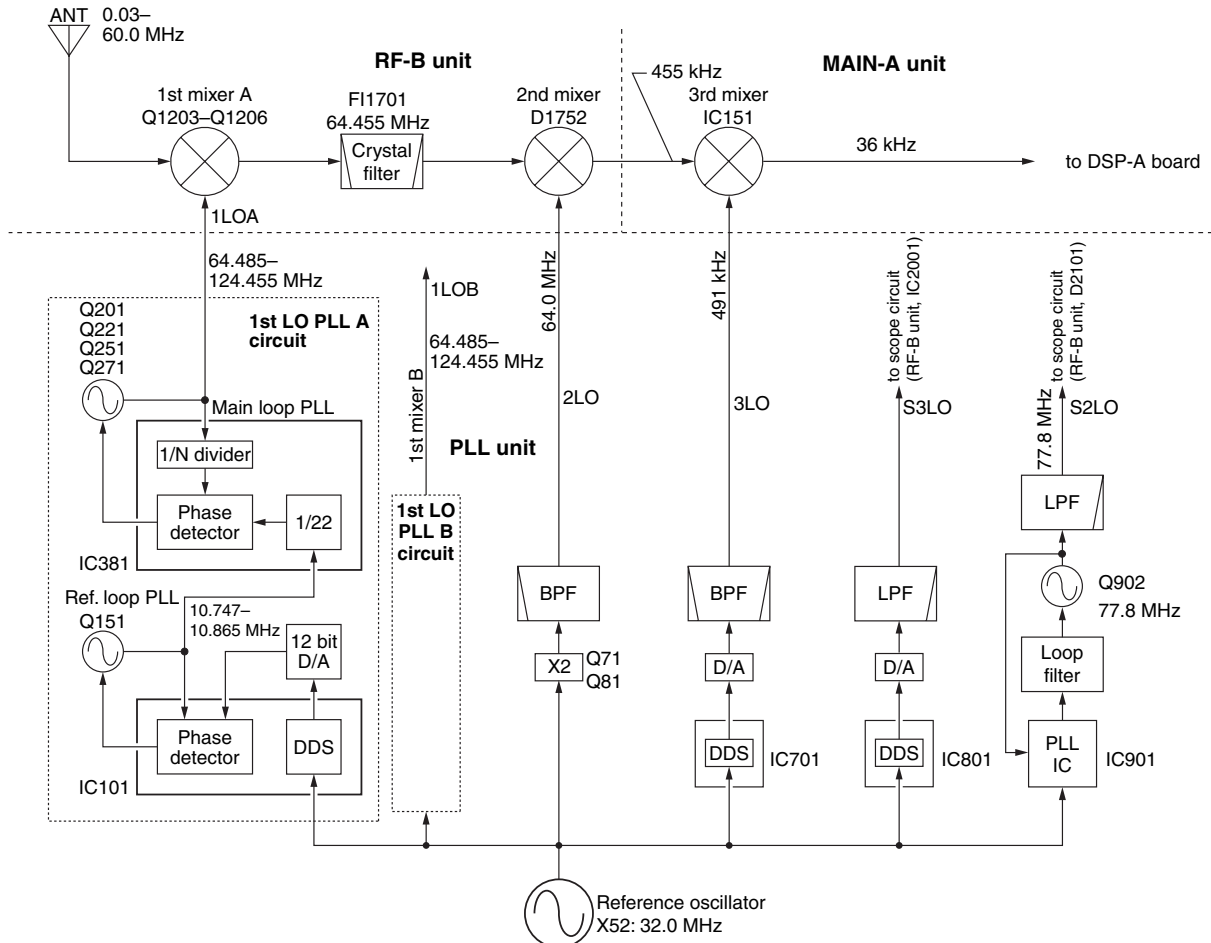

3-4 ANTENNA TUNER CIRCUITS

3-4-1 MATCHING CIRCUIT (TUNER-A UNIT)

The matching circuit is a T-network. Using 2 tuning motors, the matching circuit obtains rapid overall tuning speed.

Using relays (RL1–RL15), the relay control signals from the antenna tuner CPU (CTRL-A unit; IC5) via the buffer amplifier (IC1, IC2) ground one of the taps of L3–L12 and add capacitors (C34–C43). After selecting the coils and capacitors, 2 motors (CTRL-A unit; MF1, MF2) adjust C44 and C45 using the antenna tuner CPU (CTRL-A unit; IC5) and the motor controller (CTRL-A unit; Q211–Q218, D211, D213, D215, D217) to obtain a low SWR (Standing Wave Ratio).

3-4-2 DETECTOR CIRCUIT (CTRL-A UNIT)

(1) SWR detector

Forward and reflected power are picked up by a current transformer (L1), detected by D2 (FOR) and D1 (REF), and then amplified at IC1a and IC1b, respectively. The amplified voltages are applied to the antenna tuner CPU (IC5, pins 2, 3). The tuner CPU detects the SWR.

(2) Reactance components detector

Reactance components are picked up by comparing the phases of the RF current and RF voltage. The RF current is detected by L4 and R16 and buffer-amplified at IC14e and IC2a and then applied to the phase comparator (IC3a). RF voltages are detected by C12–C14 and then applied to the phase comparator (IC3b) after being amplified at the buffer amplifiers (IC14c, IC2b). The output signal from the phase comparator (IC3a, pin 6 for RF current, IC3b pin 7 for RF voltage) is rectified at D7 and D6 for conversion into DC voltage. The rectified voltage signals are combined, then amplified at the inverter amplifier (IC4b), then applied to the antenna tuner CPU (IC5, pin 64).

A C-MOS IC is used for the buffer amplifier (IC14) to improve functional sensitivity; the inverter amplifier (IC4) is very responsive even with a low signal level input. Together, these ensure quick and stable signal detection even at low RF signal level input.

(3) Resistance components detector

Resistance components are picked up by L8, and detected by D8, D9 and Q5. The detected resistance components are amplified at the inverter amplifier (IC4a), and then applied to the antenna tuner CPU (IC5, pin 1).

3-4-3 MOTOR CONTROL CIRCUIT (CTRL-A AND TUNER-A UNITS)

The control circuit of the internal antenna tuner consists of the CPU, EEPROM (Electrically-Erasable Programmable Read Only Memory), tuning motors and tuning relays.

(1) CPU and EEPROM (CTRL-A unit)

The antenna tuner CPU (IC5) controls the tuning motors via the motor controller (Q211–Q218, D211, D213, D215, D217) and tuning relays, and memorizes the best preset position in 100 kHz steps. The memory contents are stored in the EEPROM (IC6) without a backup battery.

(2) Tuning motors (CTRL-A and TUNER-A units)

A motor controller (Q211–Q218, D211, D213, D215, D217) rotates the tuning motors (TUNER-A unit; MF1, MF2) to obtain a low SWR.

(3) Tuning relays (TUNER-A unit)

According to the operating frequency band and antenna condition, tuning relays select the capacitors and coils.

3-4-4 ANTENNA TUNER CPU PORT ALLOCATION (CTRL-A unit; IC5)

Pin number	Port name	Description
1	AN2	Input port for the resistance components detection voltage.
2	AN1	Input port for the reflected RF power voltage.
3	AN0	Input port for the forward RF power voltage.
4	PERS	Input port for the transceiver power OFF.
13	IKEY	Outputs transmit control signal to the main CPU (IC 3501).
15	ISTA	Input port for the antenna tuner start signal.
17	THRU	Input port for the [TUNER] ON/OFF signal from main CPU (IC3501)..
21	TRC	Input port for the TX/RX switching signal.
26	VHF	Output the coil select signals for the tuner unit.
27–32	24M, 18M, 14M, 10M, 7M, 4M	Output the coil select signals to the tuner unit.
34–40	CO1–CO3, CI1–CI3	Output the capacitor select signal to the tuner unit.
41–48	AZ, AY, AX, AW, PZ, PY, PX, PW	Output pulse-type control signals for the tuning motors. (MF1, MF2)
27–32	24M, 18M, 14M, 10M, 7M, 4M	Output the coil select signal to the tuner unit.
64	AN3	Input port for the reactance components detection signal.

3-5 SCOPE CIRCUITS

3-5-1 SCOPE RECEIVER CIRCUIT (RF-B UNIT)

A portion of the 64.455 MHz 1st IF signal from the 1st mixer circuit (Q1203–Q1206: while receiving) or IF amplifier (Q1551: while transmitting) is passed through the PIN attenuator (Q2203) and amplified at the IF amplifiers (Q2202, Q2201), and then mixed with the 77.8 MHz scope 2nd LO (S2LO) signal at the mixer circuit (D2101) to produce the 13.345 MHz IF signal. The mixed IF signal is passed through the ceramic bandpass filters (FI2003, FI2002) to suppress unwanted signals. The filtered IF signal is applied to the FM IF IC (IC2001, pin 16).

The applied 13.345 MHz IF signal is mixed with the sweep LO (S3LO) signals from the PLL unit at the FM IF IC (IC2001). The mixed IF signals are filtered at the ceramic bandpass filter (FI2001) then applied to the limiter amplifier section in the FM IF IC (IC2001, pin 5). The applied IF signals are converted into DC voltages according to the applied IF signal strength at the RSSI section in the IC.

The converted voltages are output from pin12 (IC2001) and amplified at IC2002, then applied to the MAIN-A unit as the SCPL signal.

Some of the DC voltages from the FM IF IC (IC2001) are amplified at IC2002 to produce AGC voltages for the IF amplifiers (Q2201, Q2202), producing wider dynamic range.

By sweeping LO signals (S3LO) are applied to the mixer section in the FM IF IC (IC2001), the spectrum scope function is activated.

3-5-2 SWEEP LO CIRCUIT (PLL UNIT)

The sweep LO signals (S3LO) are generated by the DDS IC (IC801) using the 32 MHz system clock. A 10-bit digital signal is converted into analog wave signals at the D/A converter (R801–R820). The converted analog wave is passed through the bandpass filter (L802, L803, C809–C813) then applied to the RF-B unit via (J801) after being amplified at the buffer amplifier (Q802).

• SCOPE CIRCUIT DIAGRAM

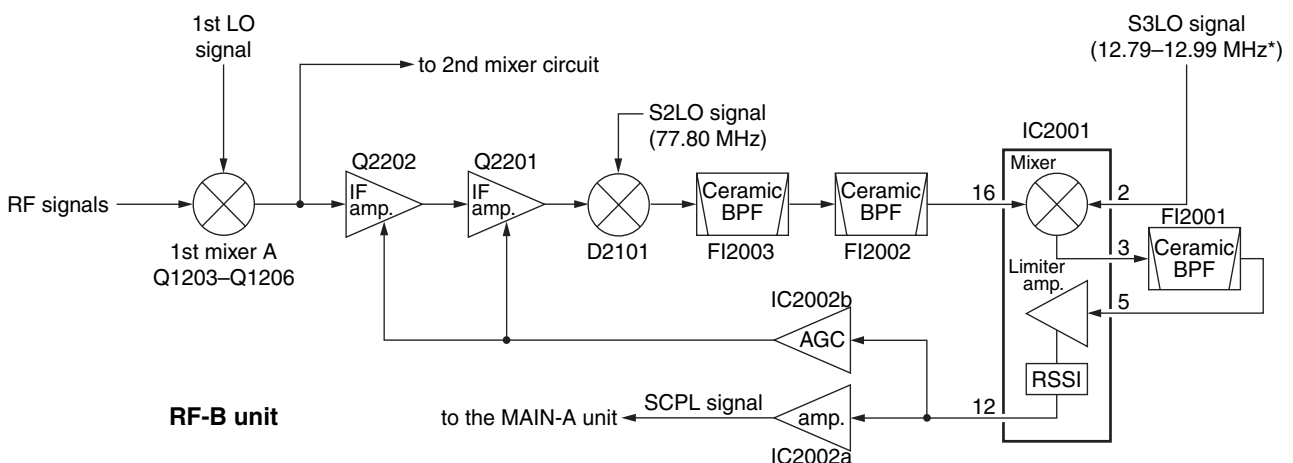

*depending on sweeping passband width

3-6 POWER SUPPLY CIRCUITS

3-6-1 PA UNIT

LINE	DESCRIPTION
PHV	The voltage from an external power supply via the common filter circuit (FILTER-A unit; L501, L502).
HV	The same voltage as the PHV line passed through a fuse (F1).
14V	The same voltage as the HV line passed through the switching relay (RL1).
14VA	The same voltage as the 14 V line is applied to the AF power amplifier (MAIN-A unit; IC332).
a8V	Common 8 V converted from the 14 V line and regulated by the +8 regulator circuit (IC3).
5V	Common 5 V converted from the 14 V line and regulated by the +5 regulator circuit (IC2).
H5V	Common 5 V converted from the HV line and regulated by the H5V regulator circuit (IC1).

3-6-2 FRONT UNIT

LINE	DESCRIPTION
5VF	Common 5 V converted from the 14 V line and regulated by the +5 regulator circuit (IC861).
-15V	Common -15 V converted from the 14 V line and converted by the -15 DC-DC converter circuit (IC841, Q841, D841). The voltage is applied to the -7 V, -8 V regulator circuits and etc.
-7V	Common -7 V converted from the -15 V line and regulated by the -7 regulator circuit (IC501).
-8V	Common -8 V converted from the -15 V line and regulated by the -8V regulator circuit (IC881).
+18V	Common 18 V converted from the 14 V line and converted by the 18 V DC-DC converter circuit (IC821, Q821, D822).

3-7-3 MAIN-CPU PORT ALLOCATIONS (MAIN-A UNIT; IC3501)

Pin number	Port name	Description
6–9, 11–18, 20–26	A0–A3, A4–A11, A12–A18	Address signal output ports for the LCD controller (IC3551).
29	SKYS	Input port for the [KEY] jack. Low : During key down
30	RTKI	Input port for the RTTY keying.
31	DPGI	Power supply detection input port for the DSP-A board.
32	DSDR	Input port for data signal from DSP-A board.
34	PWRK	Input port for the [POWER] switch. Low : When the [POWER] is pushed.
37	DSKY	Outputs CW/RTTY keying.
40–43, 45–52, 54–57	DB0–DB3, DB4–DB11, DB12–DB15	Data bus lines for the LCD controller (IC3551) and I/O expander (IC3652–IC3654).
59	CTXD	Outputs the CI-V signal.
61	CRXD	Input port for the CI-V signal.
63	MCK	Outputs clock signal.
64	MDAT	Outputs data signal.
66	TRVI	Input port for the [XVERT] detection signal.
69	IKEY	Input port for transmit control signal from the antenna tuner CPU (CTRL-A board; IC5).
70	RXS	Outputs R8V regulator (Q601, Q602, D601) control signal. Low : While receiving
71	TXS	Outputs T8V regulator (Q611, Q612, D611) control signal. Low : While transmitting
72	ISTA	Outputs antenna tuner start signal.
73	DRES	Outputs reset/inhibit signal to the sub-CPU (DISPLAY board; IC401), DDS ICs (PLL unit; IC101, IC401), antenna tuner CPU (CTRL-A board; IC5), and etc.
74	UNLC	Input port for unlock signal from the PLL unit.
75	PSTB	Outputs strobe signals for the I/O expander IC (PLL unit; IC1).
76	PSEL	Outputs strobe selection signals for the I/O expander (PLL unit; IC1).
77	CON2	Outputs control signal for the DDS circuits (PLL unit; IC101, IC401).

Pin number	Port name	Description
78	CON1 (PDAT)	Outputs data signal for the DDS circuits (PLL unit; IC101, IC401).
79	CON0 (PCK)	Outputs clock signal for the DDS circuits (PLL unit; IC101, IC401).
85, 86	XTAL, EXTAL	Input ports for the CPU system clock oscillator (X3501; 19.6608 MHz).
96	LRES	Outputs reset/inhibit signal for the LCD controller (IC3551), I/O expander (IC3652–IC3654), and etc.
97	LTXD	Outputs data signal for the sub-CPU (DISPLAY board; IC401).
98	LRXD	Input port for data signal from the sub-CPU (DISPLAY board; IC401).
101	TMD	Outputs [TIMER] indicator control signal. High: When the timer function is ON
105	SCPL	Input port for the scope signal.
106	VOXL	A/D input port for the VOX gain.
107	AVXL	A/D input port for the anti-VOX level.
108	ASO0	A/D input port via the analog switch (IC3631) for the SML signal from the S-meter amplifier circuit (IC101a), and ALCL signal from the ALC meter amplifier circuit (IC551a).
109	ASO1	A/D input port via the analog switch (IC3631) for the NSQO signal from the level converter (DSP-A board; IC2063), for noise squelch operation, and FORL signal from the power meter amplifier circuit (IC571a).
110	ASO2	A/D input port from the analog switch (IC3631) for the FNLT signal from the low-pass filter (DSP-A board; IC2472a), for tone squelch operation, and REFL signal from the SWR meter amplifier circuit (IC571b).
111	STON	Outputs CW side-tone signals.
112	BEEP	Outputs beep audio signals.
115	SENI	Input port for connected microphone's PTT switch and SEND signal from the ACC jacks. High: While PTT switch is pushed or activated from an external unit.
116	PWRS	Outputs control signal for the power switching relay (PA unit; RL1) . High: During power ON

3-7-4 INPUT EXPANDER ALLOCATIONS

(1) DISPLAY board; IC411

Pin number	Port name	Description
1	KI4	Input port for the [RIT], [Δ TX] and [CLEAR] switches.
5	MUDK	Input port for [UP] and [DN] switches of the connected microphone.
12	KI3	Input port for the [DUALWATCH], [CHANGE], [V/M] and [M/S] switches.
13	KI0	Input port for the [TUNER], [MONITOR], [NB] and [NR] switches.
14, 15	KI1, KI2	Input ports for the multi-function switches.

(2) MAIN-A unit; IC3652

Pin number	Port name	Description
11	CTFL	Input port transmission status for CW
12	RTDT	Input port for RTTY decode data.
13	EKEY	Input port for the KEY signal from the connected AH-3. Low : While tuning or tune NG
14	TCON	Input port for AH-3 connection detection. High: When AH-3 is connected.
16	VINT	Input port for interrupting signal from audio recoder.
17	VRAC	Input port for address clock signal from audio recoder.
18	SBSY	Input port for busy signal from the installed UT-102 SPEECH SYNTHESIZER.

3-7-5 OUTPUT EXPANDER ALLOCATIONS

(1) PLL unit; IC1

Pin number	Port name	Description
4	PST1	Outputs strobe signals to DDS IC (IC101) for the 1st LO PLL A circuit.
5	PST2	Outputs strobe signals to PLL IC (IC381) for the 1st LO PLL A circuit.
6	PST3	Outputs strobe signals to DDS IC (IC401) for the 1st LO PLL B circuit.
7	PST4	Outputs strobe signals to PLL IC (IC681) for the 1st LO PLL B circuit.
12	PST5	Outputs strobe signals to DDS IC (IC701) for the 3rd LO PLL circuit.
13	PST6	Outputs strobe signals to PLL IC (IC901) for the S2 LO PLL circuit.
14	PST7	Outputs strobe signals to DDS IC (IC801) for the S3 LO PLL circuit.

(2) PLL unit; IC101

Pin number	Port name	Description
66	MAKS	Outputs the marker mute switch (IC192) control signal. High: When the marker ON is selected.
68	PAMT	Outputs LO mute switch (Q361) control signal. Low : Muted
70	PAFS	Outputs bandpass filter select switch (Q351) control signal. High: When less than 8 MHz is displayed on the main band.
71	VA4S	Outputs the LO switch (Q121) control signal. High: While 45.0–60.0 MHz band is displayed on the main band.
73	VA3S	Outputs the LO switch (Q122) control signal. High: While 20.0–44.999999 MHz band is displayed on the main band.
74	VA2S	Outputs the LO switch (Q123) control signal. High: While 8.0–19.999999 MHz band is displayed on the main band.
75	VA1S	Outputs the LO switch (Q126) control signal. High: While 0.03–7.999999 MHz band is displayed on the main band.

(3) PLL unit; IC401

Pin number	Port name	Description
68	PBMT	Outputs LO mute switch (Q661) control signal. Low : Muted
70	PBFS	Outputs bandpass filter select switch (Q651) control signal. High: When less than 8 MHz is displayed on the main band.
71	VB4S	Outputs the LO switch (Q421) control signal. High: While 45.0–60.0 MHz band is displayed on the main band.
73	VB3S	Outputs the LO switch (Q422) control signal. High: While 20.0–44.999999 MHz band is displayed on the main band.
74	VB2S	Outputs the LO switch (Q423) control signal. High: While 8.0–19.999999 MHz band is displayed on the main band.
75	VB1S	Outputs the LO switch (Q426) control signal. High: While 0.03–7.999999 MHz band is displayed on the main band.

(4) CTRL-A board; IC11

Pin number	Port name	Description
4	L1S	Outputs a low-pass filter select signal. High: When 0.03–1.999999 MHz band is selected.
5	L2S	Outputs a low-pass filter select signal. High: When 2.0–4.999999 MHz band is selected.
6	L3S	Outputs a low-pass filter select signal. High: When 5.0–7.999999 MHz band is selected.
7	L4S	Outputs a low-pass filter select signal. High: When 8.0–11.999999 MHz band is selected.
11	L8S	Outputs a low-pass filter select signal. High: When 30.0–60.0 MHz band is selected.
12	L7S	Outputs a low-pass filter select signal. High: When 22.0–29.999999 MHz band is selected.
13	L6S	Outputs a low-pass filter select signal. High: When 15.0–21.999999 MHz band is selected.
14	L5S	Outputs a low-pass filter select signal. High: When 12.0–14.999999 MHz band is selected.

(6) RF-B unit; IC402

Pin number	Port name	Description
4	B7WS	Outputs a bandpass filter select signal. High: When 11–13.999999 MHz or 14.5–14.999999 MHz band is selected.
5	B7S	Outputs a bandpass filter select signal. High: When 14.0–14.499999 MHz is selected.
6	B8WS	Outputs a bandpass filter select signal. High: When 15.0–20.999999 MHz or 21.5–21.999999 MHz band is selected.
7	B8W	Outputs a bandpass filter select signal. High: When 21.0–21.499999 MHz is selected.
12	B10S	Outputs a bandpass filter select signal. High: When 50.0–54.0 MHz is selected.
13	B10WS	Outputs a bandpass filter select signal. High: When 30.0–49.999999 MHz or 54.000001 MHz band is selected.
14	B9S	Outputs a bandpass filter select signal. High: When 22–29.999999 MHz is selected.

(5) RF-B unit; IC401

Pin number	Port name	Description
4	B0S	Outputs a bandpass filter select signal. High: When 0.03–1.599999 MHz is selected.
5	B1S	Outputs a bandpass filter select signal. High: When 1.6–1.999999 MHz is selected.
6	B2S	Outputs a bandpass filter select signal. High: When 2.0–2.999999 MHz is selected.
7	B3S	Outputs a bandpass filter select signal. High: When 3.0–3.999999 MHz is selected.
11	B6S	Outputs a bandpass filter select signal. High: When 8.0–10.999999 MHz is selected.
12	B5S	Outputs a bandpass filter select signal. High: When 7.0–7.299999 MHz is selected.
13	B5WS	Outputs a bandpass filter select signal. High: When 6.0–6.999999 MHz or 7.3–7.999999 MHz band is selected.
14	B4S	Outputs a bandpass filter select signal. High: When 4.0–5.999999 MHz is selected.

(7) RF-B unit; IC403

Pin number	Port name	Description
4	AT1S	Outputs control signal for the attenuator circuit (RL102, R102, R106, R111). Low : When 6 dB attenuator is ON.
5	AT2S	Outputs control signal for the attenuator circuit (RL103, R112, R113, R114). Low : When 12 dB attenuator is ON.
6	PR1S	Outputs control signal for the pre-amplifier (PRE-AMP board; Q4201, Q4202). High: When P.AMP 1 is ON.
7	PR2S	Outputs control signal for the pre-amplifier (PRE-AMP board; Q4302). High: When P.AMP 2 is ON.
14	RANS	Output the RX antenna select signal. High: When RX antenna is selected.

(8) MAIN-A unit; IC3653

Pin number	Port name	Description
13	BSTB	Outputs strobe signals for the output expander ICs (RF-B unit; IC301, IC302).
14	ANTS	Outputs the antenna connector ([ANT1] or [ANT2]) select signal. High: When the [ANT2] is selected.
15	FSTB	Outputs strobe signals for the output expander (CTRL-A board; IC11).
16	ASTB	Outputs strobe signals for the D/A converter (IC3751).
17	MSTB	Outputs strobe signals for the output expander ICs (IC3752, IC3753).
18	AFMS	Outputs control signal for the AF mute switch (IC331). High: When the [AF] control is set to maximum counter clockwidth.
19	SQLS	Outputs squelch mute control signal, applied to the squelch gate (IC301). High: When squelch is closed.

(9) MAIN-A unit; IC3654

Pin number	Port name	Description
12	SQSS	Outputs squelch control signal for the [MIC] and [ACC1] connectors. High: Squelch open. (RX LED ON)
13	SPS	Outputs control signal for the internal speaker ON/OFF select relay (RL351). High: Internal speaker is ON.
14	SSTB	Outputs strobe signals for the optional UT-102 SPEECH SYNTHESIZER.
15	VCS	Outputs chip select signal for the audio recoder (IC3001).
16	ESTA	Outputs external antenna tuner (AH-3) start signal. Low : When the [TUNE] switch is pushed.
17, 18	DSFR, DSFW	Outputs control signal for the DSP IC (DSP-A board; IC2001).

(10) MAIN unit; IC3752

Pin number	Port name	Description
4	NBS	Outputs control signal for the noise blanker switch (Q3751, Q3752). High: When the [NB] switch is ON, except in FM mode.
6	MSL1	Outputs audio select signal for the TX monitor function. High: During monitoring in SSB or RTTY mode.
7	MSL2	Outputs audio select signal for the TX monitor function. High: During monitoring in AM or FM mode.
12	VO SL	Outputs analog switch (IC3005) control signal for the audio recoder's (IC3001) output. High: When the audio recoder's output to the AF circuit.
14	MISL	Outputs analog switch (IC3002) control signal for input of the microphone amplifier (IC461). High: Except the microphone input is selected.

(11) MAIN-A unit; IC3753

Pin number	Port name	Description
4	AMS	Outputs AM mode select signal for the AGC and APC circuit. High: When AM is selected.
5	PHFS	Outputs HF band RF power control signal. High: When 0.03–29.999999 MHz band is selected.
6	P50S	Outputs 50 MHz band RF power control signal. High: When 30–60 MHz band is selected.
7	MODS	Outputs 2nd IF filter (F1131 or F1133) select signal. High: When transmitting in AM or FM mode. (F1131 is ON)
11	DSRS	Outputs reset signal for the DSP circuit and etc.
14	FMNS	Outputs FM deviation control signal. High: When FM-N is selected.

SECTION 4 ADJUSTMENT PROCEDURES

4-1 PREPARATION

■ REQUIRED TEST EQUIPMENT

EQUIPMENT	GRADE AND RANGE	EQUIPMENT	GRADE AND RANGE
DC power supply	Output voltage : 13.8 V Current capacity : 30 A or more	Audio generator	Frequency range : 300–3000 Hz Measuring range : 1–500 mV
RF power meter (terminated type)	Measuring range : 10–200 W Frequency range : 1.8–100 MHz Impedance : 50 Ω SWR : Less than 1.2 : 1	Standard signal generator (SSG)	Frequency range : 0.1–300 MHz Output level : 0.1 μV to 32 mV (–127 to –17 dBm)
Frequency counter	Frequency range : 0.1–100 MHz Frequency accuracy : ±0.5 ppm or better Sensitivity : 100 mV or better	AC millivoltmeter	Measuring range : 10 mV–10 V
		DC voltmeter	Input impedance : 50 kΩ/V DC or better
RF voltmeter	Frequency range : 0.1–100 MHz Measuring range : 0.01–10 V	DC ammeter	Measuring range : 1 A/30 A
		Spectrum analyzer	Measuring range : At least 90 MHz Spectrum bandwidth : 100 kHz or more
Modulation analyzer	Frequency range : At least 90 MHz Measuring range : 0–100%	Attenuator	Power attenuation : 50 or 60 dB Capacity : 150 W or more
Distortion meter	Frequency range : At least 90 MHz Measuring range : 0–100%		
Oscilloscope	Frequency range : DC–20 MHz measuring range : 0.01–20 V	External speaker	Resistance : 8 Ω Capacity : 5 W or more

■ CONNECTIONS

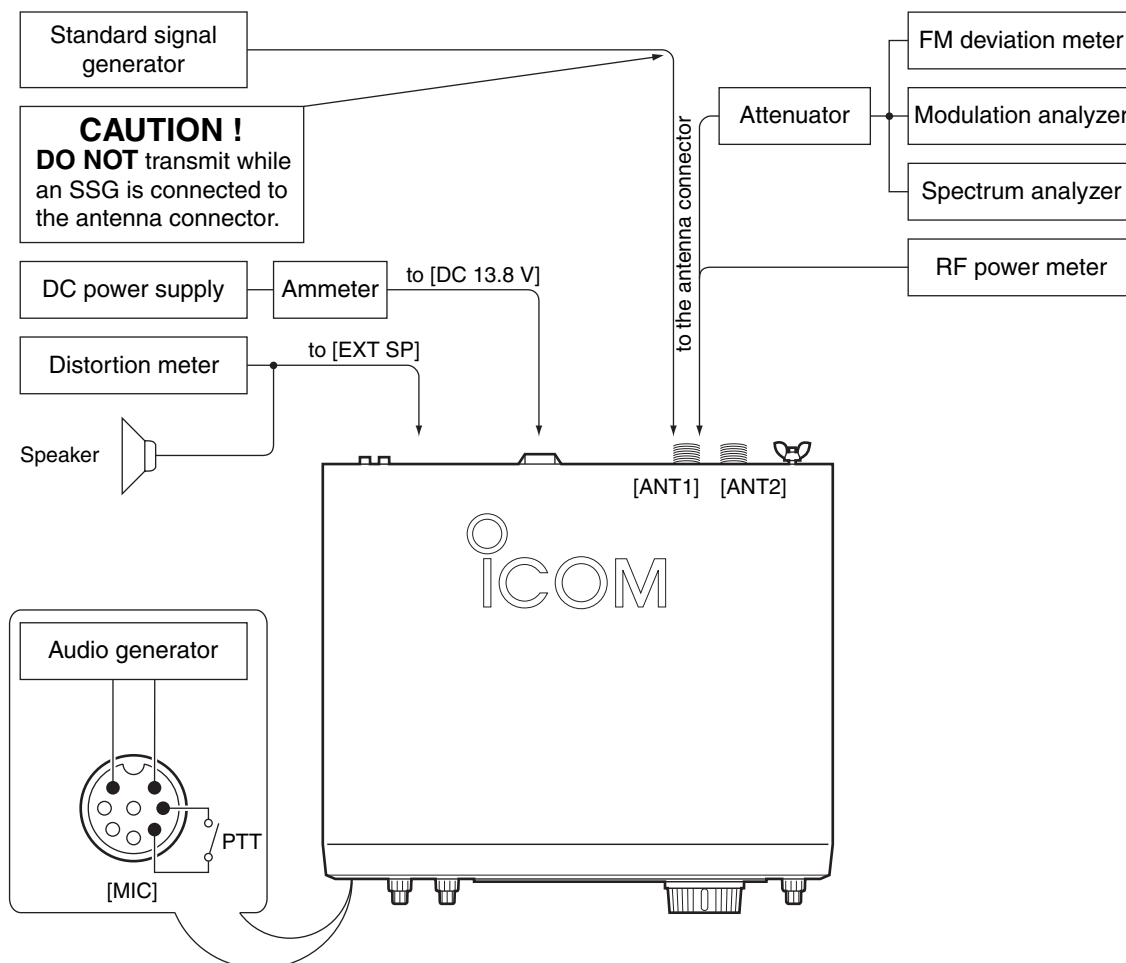

4-2 PLL ADJUSTMENTS

ADJUSTMENT		ADJUSTMENT CONDITION	MEASUREMENT		VALUE	ADJUSTMENT POINT	
			UNIT	LOCATION		UNIT	ADJUST
REFERENCE FREQUENCY	1	<ul style="list-style-type: none"> • Display freq. : Any • Turn L52 on the PLL unit to 4 rotation downside for presetting. • Receiving 	PLL	Connect a frequency counter to the check point P81.	64.000000 MHz	PLL	L52 (R33 for critical adjustment)
	2			Connect an RF voltmeter to the check point P81.			Maximum level (0 dB or more)
LPL-A LOCK VOLTAGE	1	<ul style="list-style-type: none"> • Display freq. : 0.030000 MHz • Mode : USB • Receiving 	PLL	Connect a digital multimeter or oscilloscope to the check point LPA.	2.0 V	PLL	C154
VCO-A LOCK VOLTAGE	1	<ul style="list-style-type: none"> • Display freq. : 7.999999 MHz • Mode : USB • Receiving 	PLL	Connect a digital multimeter or oscilloscope to the check point LVA.	4.3 V	PLL	C278
	2	<ul style="list-style-type: none"> • Display freq. : 19.999999 MHz • Mode : USB • Receiving 			4.3 V		C258
	3	<ul style="list-style-type: none"> • Display freq. : 44.999999 MHz • Mode : USB • Receiving 			4.3 V		C228
	4	<ul style="list-style-type: none"> • Display freq. : 60.000000 MHz • Mode : USB • Receiving 			4.3 V		C208
1LO-A OUTPUT LEVEL	1	<ul style="list-style-type: none"> • Display freq. : 0.030000 MHz, 7.999999 MHz 8.000000 MHz, 19.999999 MHz 20.000000 MHz, 44.999999 MHz 45.000000 MHz, 60.000000 MHz • Receiving 	PLL	Connect an RF voltmeter to the check point P351.	-2 dBm or more		Verify
LPL-B LOCK VOLTAGE	1	<ul style="list-style-type: none"> • Sub display freq. : 0.030000 MHz • Mode : USB • Receiving 	PLL	Connect a digital multimeter or oscilloscope to the check point LPB.	2.0 V	PLL	C454
VCO-B LOCK VOLTAGE	1	<ul style="list-style-type: none"> • Sub display freq. : 7.999999 MHz • Mode : USB • Receiving 	PLL	Connect a digital multimeter or oscilloscope to the check point LVB.	4.3 V	PLL	C578
	2	<ul style="list-style-type: none"> • Sub display freq. : 19.999999 MHz • Mode : USB • Receiving 			4.3 V		C558
	3	<ul style="list-style-type: none"> • Display freq. : 44.999999 MHz • Mode : USB • Receiving 			4.3 V		C528
	4	<ul style="list-style-type: none"> • Display freq. : 60.000000 MHz • Mode : USB • Receiving 			4.3 V		C508
1LO-B OUTPUT LEVEL	1	<ul style="list-style-type: none"> • Sub display freq. : 0.030000 MHz, 7.999999 MHz 8.000000 MHz, 19.999999 MHz 20.000000 MHz, 44.999999 MHz 45.000000 MHz, 60.000000 MHz • Receiving 	PLL	Connect an RF voltmeter to the check point P651.	-2 dBm or more		Verify
3LO OUTPUT LEVEL	1	<ul style="list-style-type: none"> • Display freq. : Any • Receiving 	PLL	Connect an RF voltmeter to the check point P701.	-16 dBm or more		Verify
S3LO OUTPUT LEVEL	1	<ul style="list-style-type: none"> • Display freq. : Any • Receiving 	PLL	Connect an RF voltmeter to the check point P801.	-10 dBm or more		Verify

PLL ADJUSTMENTS—continued

ADJUSTMENT	ADJUSTMENT CONDITION	MEASUREMENT		VALUE	ADJUSTMENT POINT	
		UNIT	LOCATION		UNIT	ADJUST
S2LO OUTPUT LEVEL	1 • Display freq. : Any • Receiving	PLL	Connect an RF voltmeter to the check point P901.	-3 dBm or more		Verify
MARKER OUTPUT LEVEL	1 • Display freq. : Any • Receiving	PLL	Connect an oscilloscope to the check point P851.	4 Vp-p or more		Verify

• PLL unit

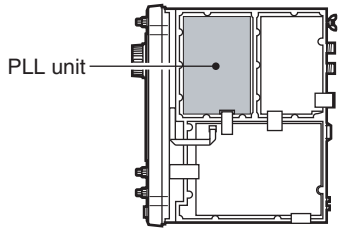

Bottom view of the transceiver

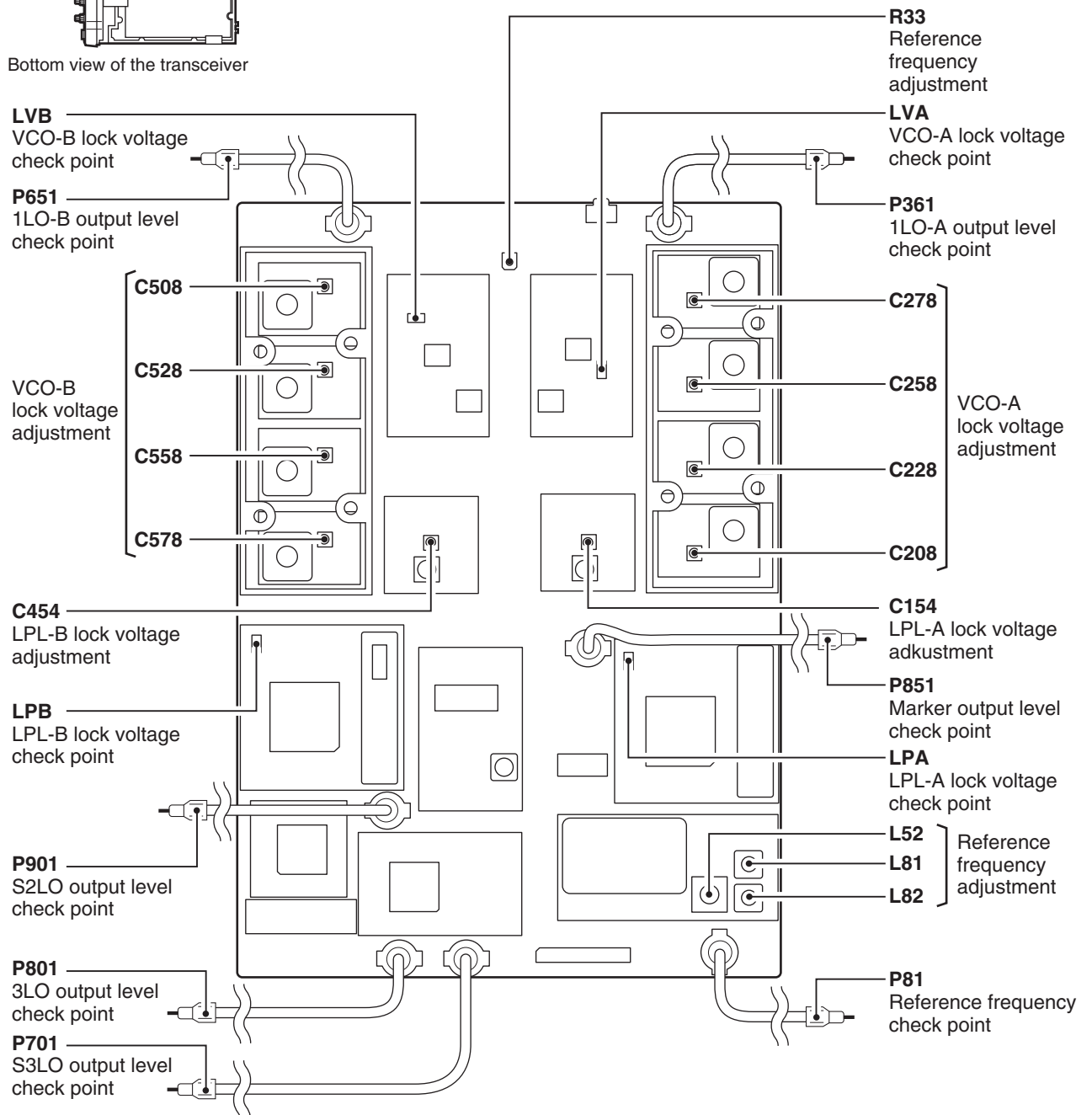

4-3 TRANSMITTER ADJUSTMENTS

ADJUSTMENT	ADJUSTMENT CONDITION	MEASUREMENT		VALUE	ADJUSTMENT POINT		
		UNIT	LOCATION		UNIT	ADJUST	
IDLING CURRENT (for drive)	1	<ul style="list-style-type: none"> • Display freq. : 14.100000 MHz • Mode : CW (Key up) • Preset R11, R18 on the PA unit to max. CCW • [RF POWER] : Max. CW • [TUNER] : OFF • Transmitting (without key) 	PA	Unsolder W29. Connect an ammeter to the unsoldering points of W29.	250 mA	PA	R11
	After adjustment, re-solder the wire (W29) on the PA board						
(for final amplifier)	2	<ul style="list-style-type: none"> • Transmitting (without key) 	PA	Unsolder R28 (L8 side). Connect an ammeter to the unsoldering points of R28.	500 mA	PA	R18
	After adjustment, re-solder the wire (W29) on the PA board						
TX PEAK	1	<ul style="list-style-type: none"> • Display freq. : 14.100000 MHz • Mode : USB • Set following selections, controls and functions as : [VOX] : OFF , [TX] : OFF PBT1 : Center, PBT2 : Center Filter : 2.4 kHz [RF POWER]: Max. CW [MIC GAIN] : Center [TUNER] : OFF [METER] : METER Po [MONITOR] : OFF • Apply no audio signals to [MIC] connector. • Transmitting 	MAIN-A	Connect a digital multimeter or oscilloscope to the check point CP243.	0.06 V	MAIN-A	R247
	2	<ul style="list-style-type: none"> • Connect an audio generator to [MIC] connector and set as: Frequency : 1.5 kHz Level : 1 mVrms • Transmitting 	Rear panel	Connect an RF power meter to [ANT1] connector.	50 W	Front panel	[MIC GAIN] control
	3	<ul style="list-style-type: none"> • Transmitting 			Maximum output power	MAIN-A	L261
	4	<ul style="list-style-type: none"> • [MIC GAIN] : Center • Preset L1701, L1702's top to same high with coil's case. • Connect an audio generator to [MIC] connector and set as: Frequency : 1.5 kHz Level : 10 mVrms • Transmitting 	RF-B	Connect an RF voltmeter the check point J201.	Maximum level	RF-B	L1801, L1553, L1702, L1701
	Adjust in sequence L1801, L1553, L1702, L1701, L1702, L1701						
TRANSMITTER TOTAL GAIN	1	<ul style="list-style-type: none"> • Display freq. : 14.100000 MHz • Mode : USB • [MIC GAIN] : Center • Connect an audio generator to [MIC] connector and set as: Frequency : 1.5 kHz Level : 1 mVrms • Transmitting 	Rear panel	Connect an RF power meter to [ANT1] connector.	50 W	MAIN-A	R263

• PA unit

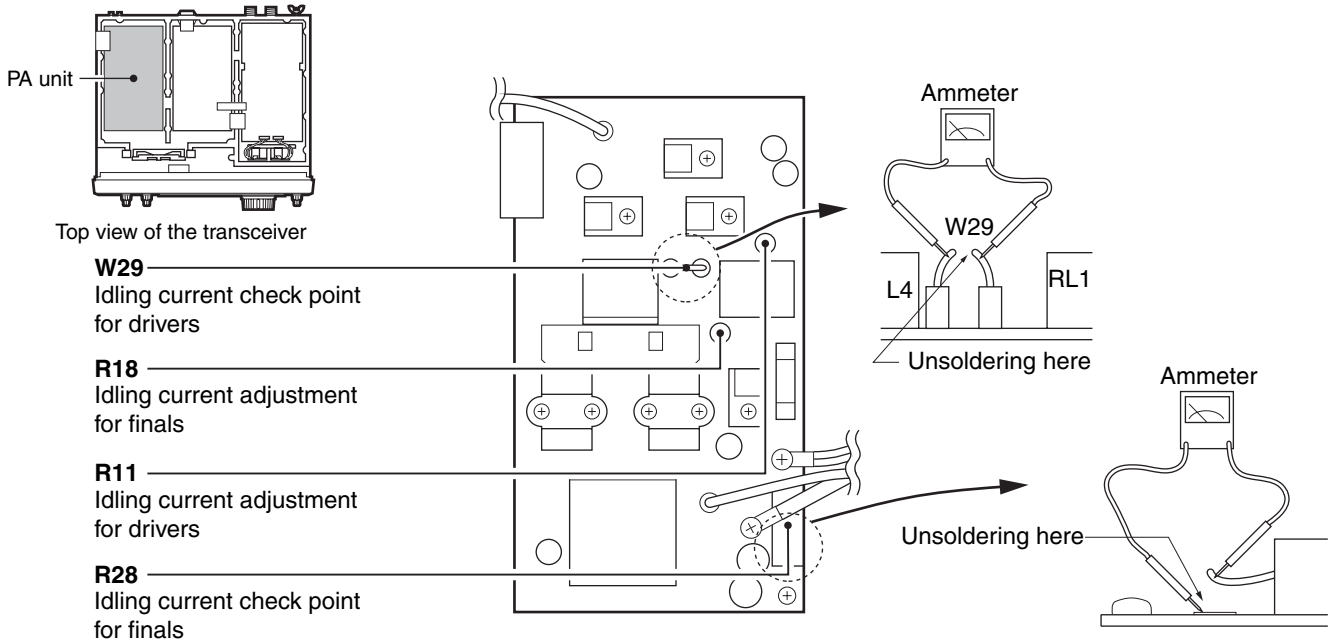

• MAIN-A unit

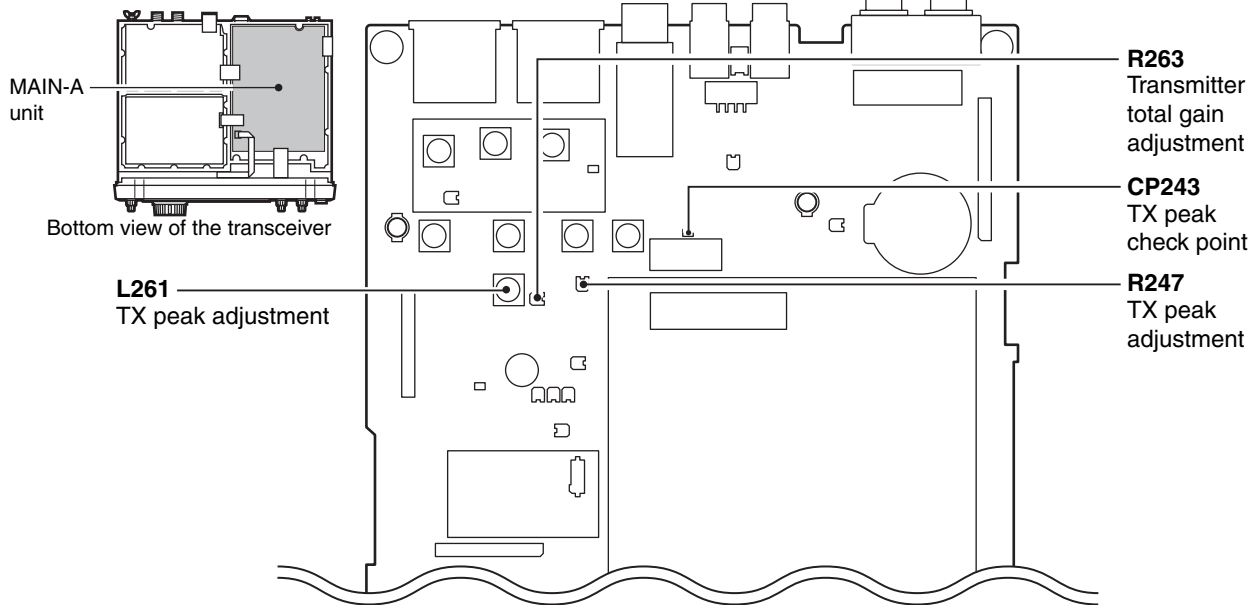

• RF-B unit

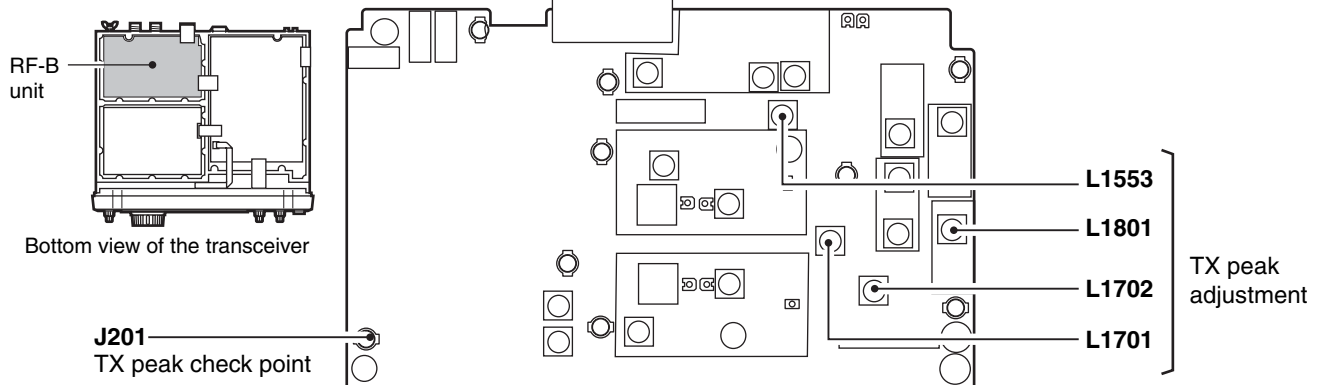

TRANSMITTER ADJUSTMENTS—continued

ADJUSTMENT	ADJUSTMENT CONDITION	MEASUREMENT		VALUE	ADJUSTMENT POINT	
		UNIT	LOCATION		UNIT	ADJUST
Ic APC	1 <ul style="list-style-type: none"> • Display freq. : 3.550000 MHz • Mode : RTTY • Connect CP501 to GND. • Transmitting 	Rear panel	Connect an ammeter between power supply and the IC-756PROIII.	23 A	MAIN-A	R545
HF BANDS OUTPUT POWER	1 <ul style="list-style-type: none"> • Display freq. : 14.100000 MHz • Mode : RTTY • [RF POWER] : Max. CW • [TUNER] : OFF • Transmitting 	Rear panel	Connect an RF power meter to [ANT1] connector.	105 W	MAIN-A	R507
50 MHz BAND OUTPUT POWER	1 <ul style="list-style-type: none"> • Display freq. : 51.000000 MHz • Mode : RTTY • [RF POWER] : Max. CW • [TUNER] : OFF • Transmitting 	Rear panel	Connect an RF power meter to [ANT1] connector.	100 W	MAIN-A	R509
FM DEVIATION	1 <ul style="list-style-type: none"> • Display freq. : 29.600000 MHz • Mode : FM • Filter : 15 kHz • [RF POWER] : Max. CW • [MIC GAIN] : Center • Connect an audio generator to [MIC] connector and set as: Frequency : 1 kHz Level : 10 mVrms • Transmitting 	Rear panel	Connect an FM deviation meter to [ANT1] connector through an attenuator.	±4.5 kHz	DSP-A	R2227
AM CARRIER POWER	1 <ul style="list-style-type: none"> • Display freq. : 14.100000 MHz • [RF POWER] : Max. CW • Mode : AM • [MIC GAIN] : Center • Apply no audio signals to [MIC] connector. • Transmitting 	Rear panel	Connect an RF power meter to [ANT1] connector.	40 W	MAIN-A	R510
AM MODULATION	1 <ul style="list-style-type: none"> • Display freq. : 14.100000 MHz • Mode : AM • [MIC GAIN] : Center • [RF POWER] : Max. CCW • Connect an audio generator to [MIC] connector and set as: Frequency : 1 kHz Level : 10 mVrms 	Rear panel	Connect a modulation analyzer to [ANT1] connector through an attenuator.	90%	DSP-A	R2229

• **MAIN-A unit**

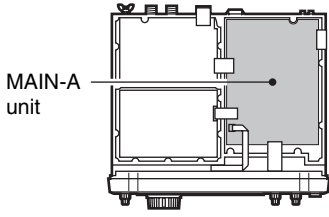

Bottom view of the transceiver

R509
50 MHz band output power adjustment

CP501
Ic APC check point

R507
HF bands output power adjustment

R545
Ic APC adjustment

R510
AM carrier adjustment

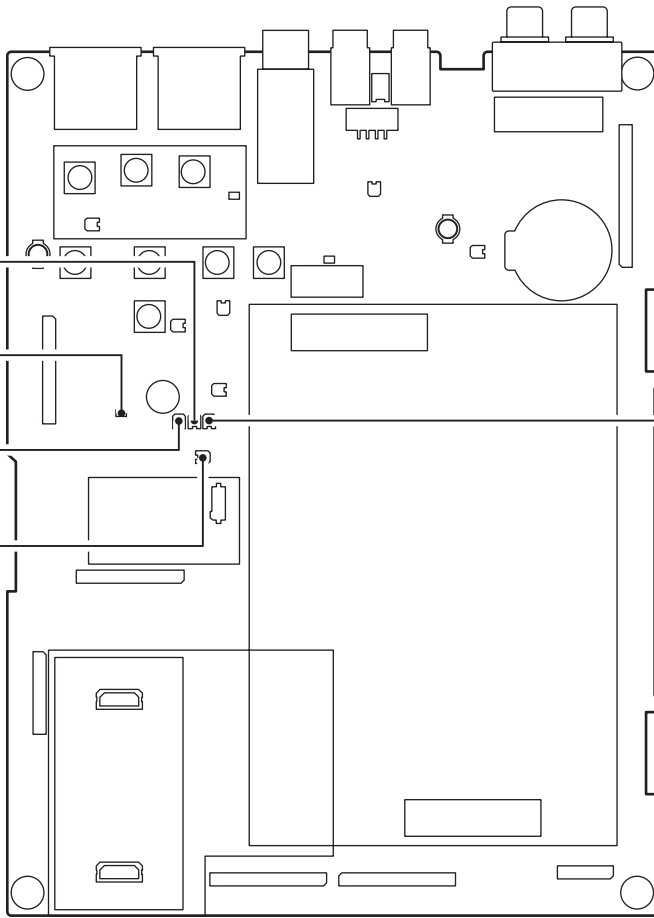

• **DSP-A board**

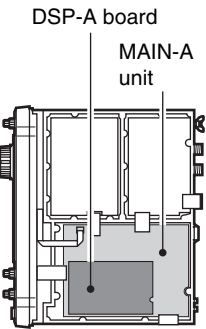

Bottom view of the transceiver

R2227
FM deviation adjustment

R2229
AM modulation adjustment

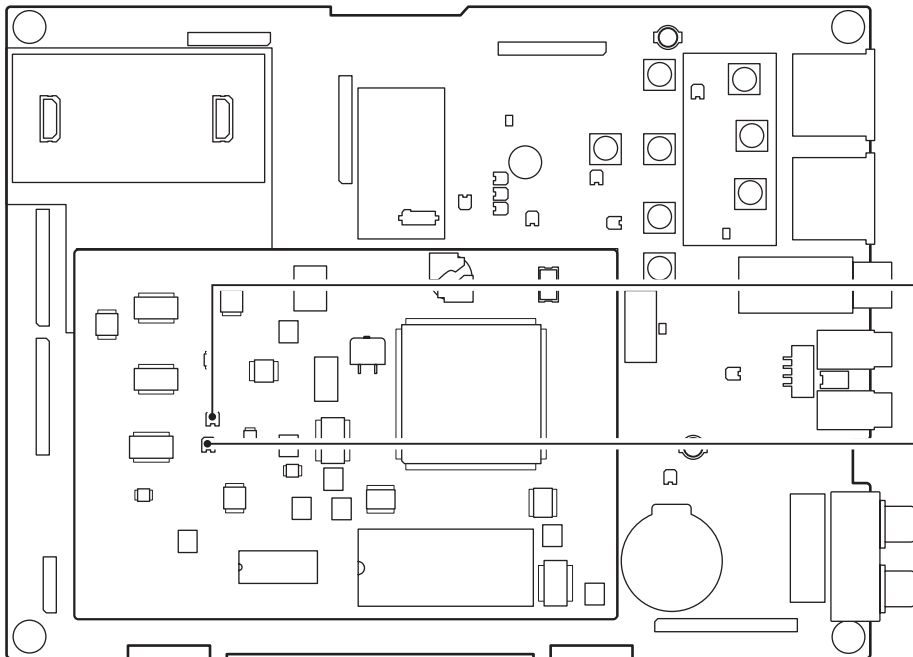

4-4 RECEIVER ADJUSTMENTS

ADJUSTMENT	ADJUSTMENT CONDITION	MEASUREMENT		VALUE	ADJUSTMENT POINT		
		UNIT	LOCATION		UNIT	ADJUST	
RX PEAK	1	<ul style="list-style-type: none"> • Display freq. : 14.100000 MHz • [DUALWATCH] : OFF • Mode : USB • Set following selections, controls and functions as: [AGC] : MID [ATT] : OFF [NB] : OFF [RIT] : OFF PBT1 : Center PBT2 : Center Filter : 2.4 kHz [P.AMP] : P.AMP1 [RF/SQL] : Center [NOTCH] : OFF [NR] switch : OFF • Preset center dots to 90° difference on the roter and stater of C1036 and C1211. • Connect an SSG to [ANT1] connector and set as: Frequency : 14.101500 MHz Level : 10 μV* (-87 dBm) Modulation : 1 kHz/±5.0 kHz dev. • Receiving 	Rear panel	Connect an AC millivoltmeter to [EXT SP] connector with an 8 Ω load.	Minimum audio output level	RF-B	L1211, L1751, L1752, C1238
	Adjust L211 to upper side of 2 peak points.						
RX PEAK	2	<ul style="list-style-type: none"> • Sub display freq. : 14.100000 MHz • [DUALWATCH] : ON • Mode : USB • [BAL] : Max. CW • Set an SSG as: Level : 10 μV* (-87 dBm) • Receiving 	Rear panel	Connect an AC millivoltmeter to [EXT SP] connector with an 8 Ω load.	Minimum audio output level	RF-B	L1011, C1036
	Adjust L1011 to upper side of 2 peak points.						
FM DISTORTION	1	<ul style="list-style-type: none"> • Display freq. : 14.100000 MHz • [DUALWATCH] : OFF • Mode : FM • Filter : 15 kHz • [P.AMP] : P.AMP1 • Connect an SSG to [ANT1] connector and set as: Frequency : 14.100000 MHz Level : 500 μV* (-53 dBm) Modulation : 1 kHz/±5.0 kHz Dev. • Receiving 	Rear panel	Connect a distortion meter to [EXT SP] connector with an 8 Ω load.	Minimum distortion level	RF-B	L1751, L1702
	Adjust in sequence L1751, L1702, L1751.						
MIXER BALANCE	1	<ul style="list-style-type: none"> • Display freq. : 1.900000 MHz • Sub display freq. : 1.900000 MHz • [DUALWATCH] : ON • Mode : USB • [BAL] : Max. CCW • Apply no RF signal to [ANT1] connector. • Receiving 	Rear panel	Connect a spectrum analyzer to the check point J1651.	Minimum noise output level.	RF-B	R1206, R1207
	2	<ul style="list-style-type: none"> • [BAL] : Max. CW • Receiving 					R1006, R1007

*This output level of standard signal generator (SSG) is indicated as SSG's open circuit.

• RF-B unit

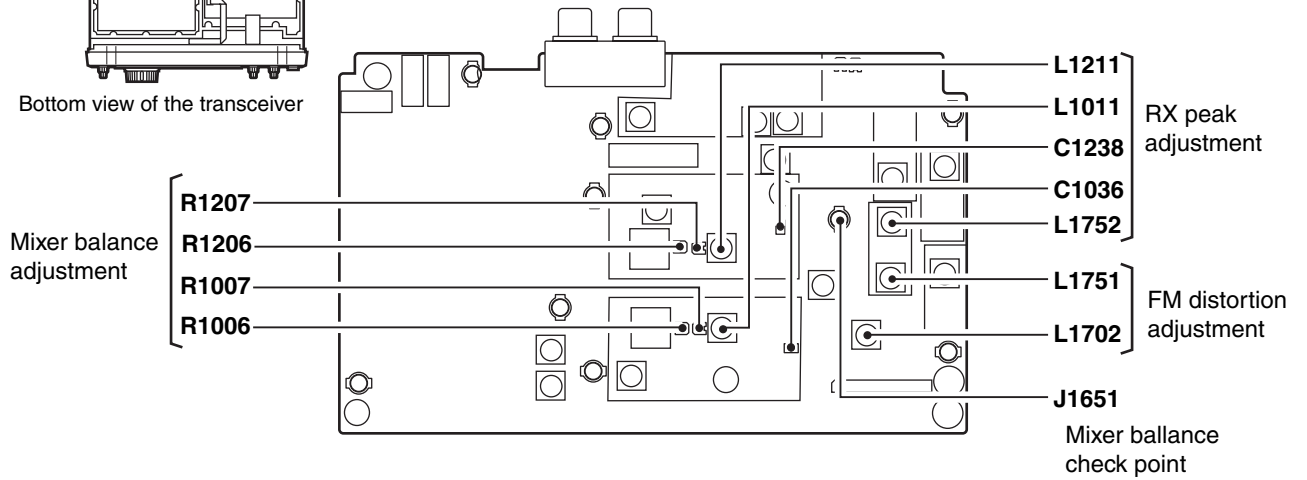
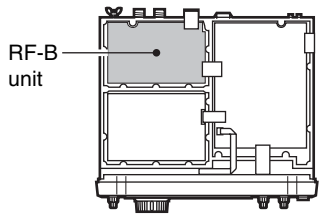

• MAIN-A unit

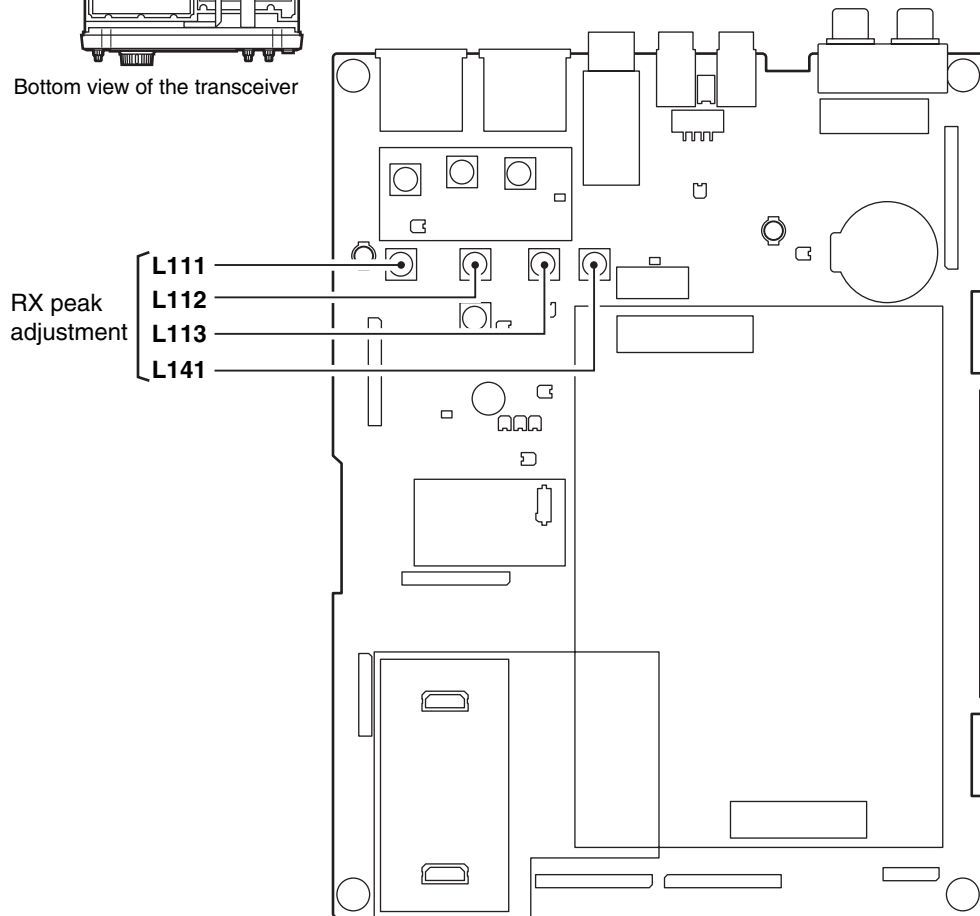
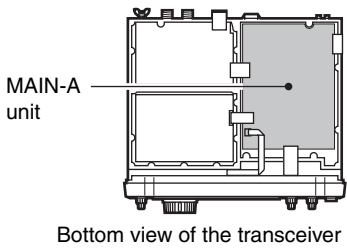

RECEIVER ADJUSTMENTS—continued

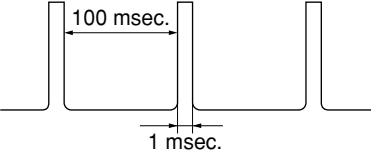
ADJUSTMENT	ADJUSTMENT CONDITION	MEASUREMENT		VALUE	ADJUSTMENT POINT		
		UNIT	LOCATION		UNIT	ADJUST	
RECEIVER TOTAL GAIN	1 <ul style="list-style-type: none"> • Display freq. : 14.100000 MHz • [DUALWATCH] : OFF • Mode : USB • Filter : 2.4 kHz • [AGC] : OFF • [P.AMP] : OFF • Connect an SSG to [ANT1] connector and set as: <ul style="list-style-type: none"> Frequency : 14.101500 MHz Level : 160 mV* (-3 dBm) Modulation : OFF • Receiving 	MAIN-A	Connect an oscilloscope to the check point CP213.	3.7 Vp-p	MAIN-A	R210	
NOISE BLANKER	1 <ul style="list-style-type: none"> • Display freq. : 14.100000 MHz • [DUALWATCH] : OFF • Mode : USB • [AGC] : MID • [P.AMP] : P.AMP1 • [NB] : OFF • [NB LEVEL] : 50% • Connect an SSG to [ANT1] connector and set as: <ul style="list-style-type: none"> Frequency : 14.101500 MHz Level : 5.6 μV* (-92 dBm) Modulation : OFF and apply following signal to [ANT1] connector.  <ul style="list-style-type: none"> • Preset R271 on the MAIN-A unit to the center position. • Receiving 	MAIN-A	Connect an oscilloscope to the check point CP271.	Maximum noise level	MAIN-A	L271, L272, L273	
	2 <ul style="list-style-type: none"> • [NB] : ON • Receiving 					At the point where the voltage just reduces.	R271
SPECTRUM SCOPE	1 <ul style="list-style-type: none"> • Display freq. : 14.100000 MHz • Mode : USB • [DUALWATCH] : OFF • [P.AMP] : OFF • [SCOPE] : ON • [SCOPE ATT] : OFF • Verify the connection of J2001 on the RF-B unit and P801 (S3LO: 12.89000 MHz/-7 dBm) from the PLL unit. • Connect an SSG to [ANT1] connector and set as: <ul style="list-style-type: none"> Frequency : 14.101500 MHz Level : 1 μV* (-107 dBm) Modulation : OFF • Receiving 	RF-B	Connect a digital multimeter or oscilloscope to the check point CP2002.	Maximum voltage	RF-B	L2102, L2201, L2202	
	2 <ul style="list-style-type: none"> • Set an SSG output level to OFF. • Receiving 					0.1 V	R2012
	3 <ul style="list-style-type: none"> • Set an SSG output level as: <ul style="list-style-type: none"> Level : 50 mV* (-13 dBm) • Receiving 					4.4 V	R2016

*This output level of a standard signal generator (SSG) is indicated as SSG's open circuit.

• **MAIN-A unit**

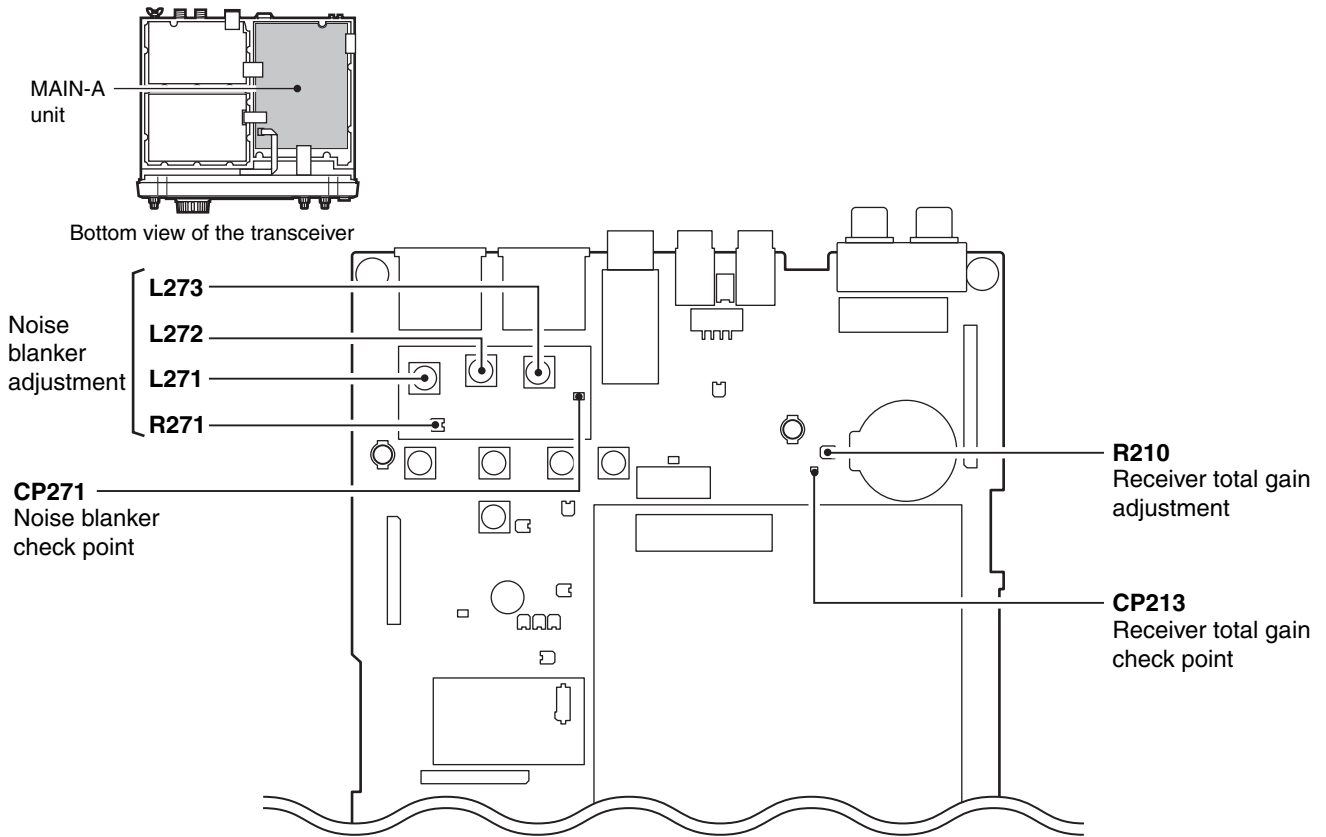

• **RF-B unit**

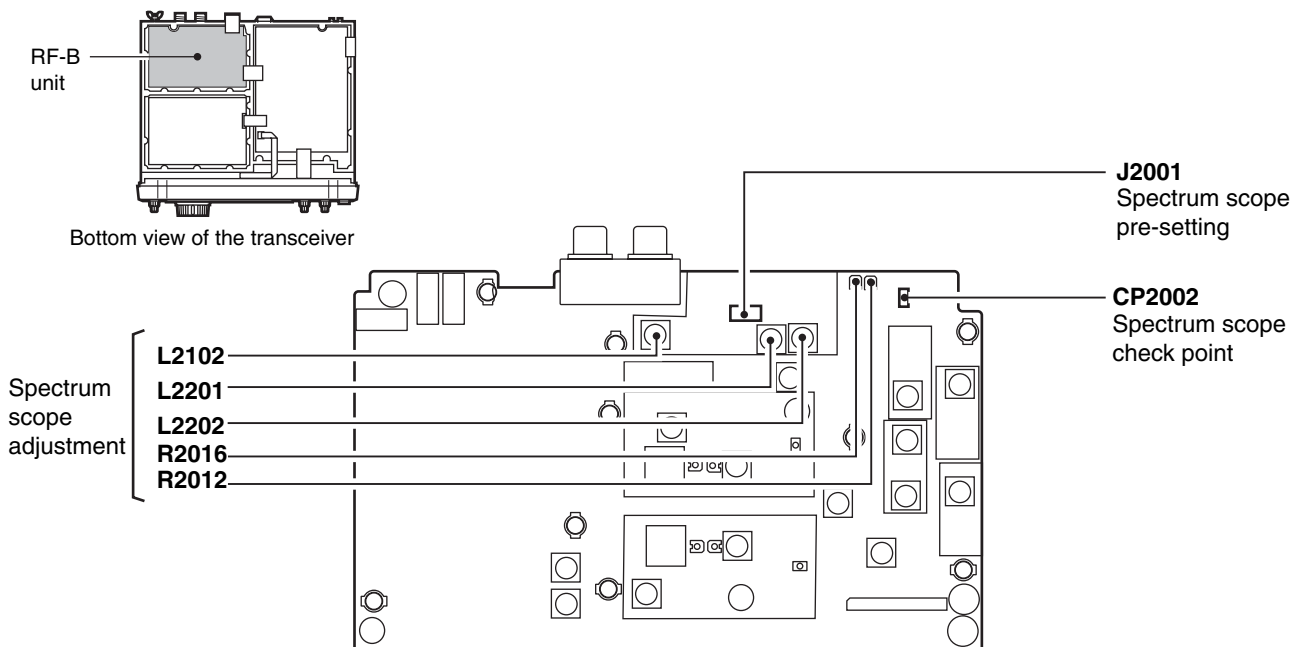

4-5 TUNER ADJUSTMENTS

ADJUSTMENT	ADJUSTMENT CONDITION	MEASUREMENT		VALUE	ADJUSTMENT POINT		
		UNIT	LOCATION		UNIT	ADJUST	
SWR DETECTOR	1	<ul style="list-style-type: none"> • Display freq.: 29.70000 MHz • Mode : FM • [RF POWER] : Max. CW • [TUNER] : Through • Connect a 50 Ω dummy load to [ANT1] connector. • Transmitting 	CTRL-A	Connect a digital multimeter or oscilloscope to the check point J14.	Minimum voltage	CTRL-A	C3
		ADJUSTMENT CONDITION	DISPLAY		OPERATION		
	2	<ul style="list-style-type: none"> • Enter the tuner adjustment mode: <ol style="list-style-type: none"> ① Turn power OFF. ② Terminate the [REMOTE] jack with a 3.5 (d) mm mini-plug. ③ While pushing [FILTER] and [EXIT/SET], turn power ON. 	TUNER-ADJUSTMENT MODE		Push [F5 (START)] to start tuning.		
	3		--TUNER-- Adjusting Now		Verify the display shows "Adjusting Now".		
4	--TUNER-- OK		Verify the display shows "OK".				

• CTRL-A unit

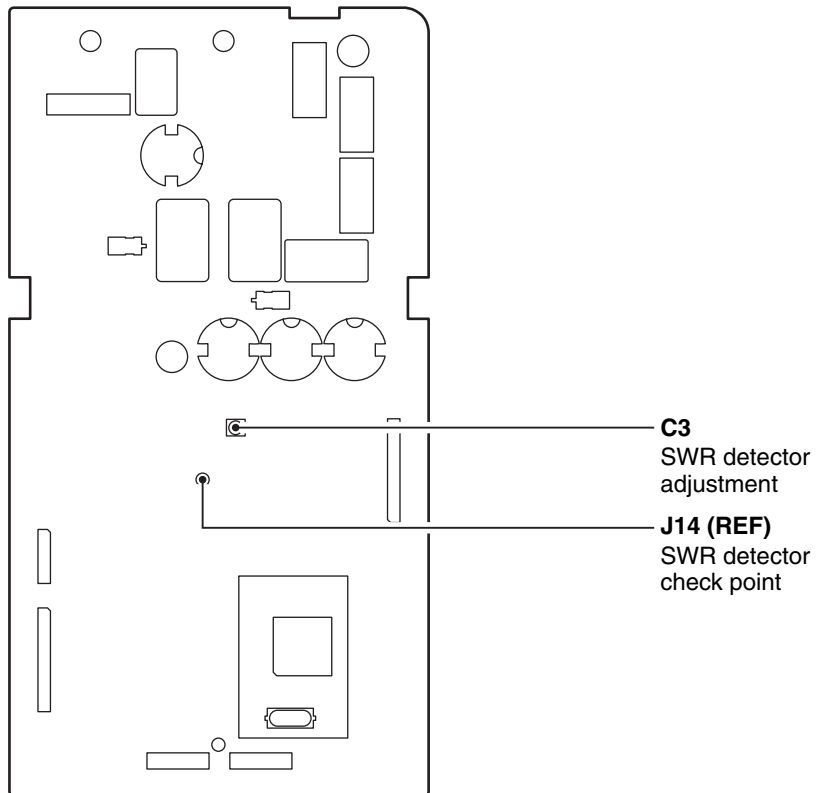
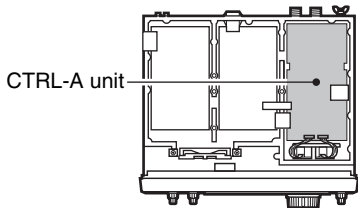

4-6 METER ADJUSTMENTS

ADJUSTMENT	ADJUSTMENT CONDITION	DISPLAY	OPERATION
ENTERING ADJUSTMENT MODE	1	ADJUST MODE	Push [F-1 (METER)], [F-2 (TX)] or [F-3 (RX)] to select each adjustment mode. Once entering adjustment mode, use [F-1 (▼)] to skip items, or [F-2 (EXIT)] to return the opening display.
	<ul style="list-style-type: none"> Enter the adjustment mode: <ol style="list-style-type: none"> Turn power OFF. Terminate the [REMOTE] jack with a 3.5(d) mm mini-plug. While pushing [SSB] and [CW/RTTY], turn power ON. <p>CAUTION: NEVER select adjustment items [F-2 (TX)] while transceiver is connected to an SSG. Because transceiver automatically transmits when transmit item in the [F-2 (TX)] is selected.</p>		
METER SCALE	1	-- METER -- SCALE S1	Set the analog meter to S1 position using the tuning dial. Then push [F-5 (SET)] to store the "S1" meter into memory, and go to the next step.
	2	-- METER -- SCALE S3	Set the analog meter to S3 position using the tuning dial. Then push [F-5 (SET)] to store the "S3" meter into memory, and go to the next step.
	3	-- METER -- SCALE S5	Set the analog meter to S5 position using the tuning dial. Then push [F-5 (SET)] to store the "S5" meter into memory, and go to the next step.
	4	-- METER -- SCALE S7	Set the analog meter to S7 position using the tuning dial. Then push [F-5 (SET)] to store the "S7" meter into memory, and go to the next step.
	5	-- METER -- SCALE S9	Set the analog meter to S9 position using the tuning dial. Then push [F-5 (SET)] to store the "S9" meter into memory, and go to the next step.
	6	-- METER -- POWER S+20	Set the analog meter to S9+20 position using the tuning dial. Then push [F-5 (SET)] to store the "S9+20" meter into memory, and go to the next step.
	7	-- METER -- POWER S9+40	Set the analog meter to S9+40 position using the tuning dial. Then push [F-5 (SET)] to store the "S9+40" meter into memory, and go to the next step.
	8	-- METER -- SCALE S9+60	Set the analog meter to S9+60 position using the tuning dial. Then push [F-5 (SET)] to store the "S9+60" meter into memory, and returns to the opening display.
TX METER (HF POWER METER)	1	-- TX -- POWER 0%	Push [F-5 (SET)] to store the "POWER 0%" meter into memory, and go to the next step.
	2	-- TX -- POWER HF Tuner	Set the output power to 10 W using the tuning dial. Then push [F-5 (SET)] to store the "POWER HF Tuner" meter into memory, and go to the next step.
	3	-- TX -- POWER HF 10%	Set the output power to 10 W using the tuning dial. Then push [F-5 (SET)] to store the "POWER HF 10%" meter into memory, and go to the next step.
	4	-- TX -- POWER HF 25%	Set the output power to 25 W using the tuning dial. Then push [F-5 (SET)] to store the "POWER HF 25%" meter into memory, and go to the next step.
	5	-- TX -- POWER HF 50%	Set the output power to 50 W using the tuning dial. Then push [F-5 (SET)] to store the "POWER HF 50%" meter into memory, and go to the next step.
	6	-- TX -- POWER HF 100%	Set the output power to 104 W using the tuning dial. Then push [F-5 (SET)] to store the "POWER HF 100%" meter into memory, and go to the next step.

METER ADJUSTMENTS—continued

ADJUSTMENT	ADJUSTMENT CONDITION	DISPLAY	OPERATION	
(50M POWER METER)	7	<ul style="list-style-type: none"> • Connect an RF power meter to [ANT1] connector. • Connect a 100 Ω dummy load to [ANT2] connector. 	-- TX -- POWER 50M Tuner	Set the output power to using the tuning dial. Then push [F-5 (SET)] to store the "POWER 50M Tuner" meter into memory, and go to the next step.
	8	<ul style="list-style-type: none"> • Connect an audio generator to [MIC] connector and set as: Frequency : 1.5 kHz Level : 10 mVrms 	-- TX -- POWER 50M 10%	Set the output power to using the tuning dial. Then push [F-5 (SET)] to store the "POWER 50M 10%" meter into memory, and go to the next step.
	9		-- TX -- POWER 50M 25%	Set the output power to using the tuning dial. Then push [F-5 (SET)] to store the "POWER 50M 25%" meter into memory, and go to the next step.
	10		-- TX -- POWER 50M 50%	Set the output power to using the tuning dial. Then push [F-5 (SET)] to store the "POWER 50M 50%" meter into memory, and go to the next step.
	11		-- TX -- POWER 50M 100%	Set the output power to using the tuning dial. Then push [F-5 (SET)] to store the "POWER 50M 100%" meter into memory, and go to the next step.
(ALC METER)	12	--TX-- ALC	Push [F-5 (SET)] to store the "ALC" meter into memory, and go to the next step.	
(DRIVE LEVEL)	13	-- TX -- DRIVE	Push [F-5 (SET)] to store the "DRIVE" meter into memory, and go to the next step.	
(SWR METER)	14	-- TX -- SWR	Push [F-5 (SET)] to store the "SWR" meter into memory, and returns to the opening display.	
RX METER ADJUSTNET (SCOPE SCALE)	1	<ul style="list-style-type: none"> • Push [F-3 (RX)] to enter the RX meter adjustment. • Connect an SSG to [ANT1] connector and set as: Frequency : 14.151500 MHz Level : 10 mVrms Modulation : OFF • Receiving 	-- RX -- SCOPE L4	Push [F-5 (SET)] to store the "SCOPE" level into memory, and go to the next step.
(S-METER)	2	NOTE: During S-METER adjustment, NEVER change the connected SSG's level until the transceiver emits "Pi Pi" and changes indication.		
		<ul style="list-style-type: none"> • Set SSG as: Frequency : 1.5 kHz Level : 10 mVrms • Receiving 	-- RX -- S0 LEVEL	Push [F-5 (SET)] to store the "S0" level into memory, and go to the next step.
	3	<ul style="list-style-type: none"> • Set SSG as: Level : 50 μV Modulation : OFF • Receiving 	-- TX -- S9 LEVEL	Push [F-5 (SET)] to store the "S9" level into memory, and go to the next step.
	4	<ul style="list-style-type: none"> • Set SSG as: Level : 50 mV (−13 dB) Modulation : OFF • Receiving 	-- TX -- S9+60 LEVEL	Push [F-5 (SET)] to store the "S9+60" level into memory, and returns to the opening display..

*This output level of a standard signal generator (SSG) is indicated as SSG's open circuit.

SECTION 5 PARTS LIST

[FRONT UNIT]

REF NO.	ORDER NO.	DESCRIPTION	M.	H/V LOCATION
DS1	5080000450	LMP SLU2LC1EX5B-TH		
ME1	5510000490	MTR ME-41 (KL-293S-11) SX2495		
W1	8900009660	CBL OPC-964 (P=1 N=10 L=60)		
W2	8900009660	CBL OPC-964 (P=1 N=10 L=60)		
W3	8900009660	CBL OPC-964 (P=1 N=10 L=60)		
W4	8900009240	CBL OPC-909 (P=1 N=10 L=110)		
W5	8900009240	CBL OPC-909 (P=1 N=10 L=110)		
W6	8900009260	CBL OPC-911 (P=1 N=16 L=70)		
W7	8900009260	CBL OPC-911 (P=1 N=16 L=70)		
W8	8900009400	CBL OPC-926 (P=1 N=24 L=70)		
EP1	6910011090	SUT RMS20-250-201-P		
EP2	6450001230	E.OTH HLJ0999-01-480		
EP3	6450001230	E.OTH HLJ0999-01-480		
EP4	6910012500	UBD TFD50W40-A		

[DISPLAY UNIT]

REF NO.	ORDER NO.	DESCRIPTION	M.	H/V LOCATION
IC101	1130011130	S.IC BU4030BF-E2	T	33.9/6.2
IC102	1130008650	S.IC MC14071BF-EL	T	47.7/7.1
IC401	1140008850	S.IC HD6433832SD66H	T	62.9/45.1
IC411	1130009640	S.IC BU4051BCFV-E2	T	69.4/70.7
IC490	1110005770	S.IC S-80942CNMC-G9C-T2	B	89.4/25.6
IC492	1130003760	S.IC TC4S81F (TE85R)	B	94.3/26.9
IC501	1180001920	S.IC TA79L08F (TE12L)	T	121.2/23.1
IC511	1110002680	S.IC NJM2902M-T1	B	80.8/34
IC542	1120002740	S.IC TK16105MTL	B	63.1/23.6
IC821	1110002350	S.IC BA6161F	T	101.6/64.5
IC841	1110006250	S.IC NJM2360AM-TE3	T	131.7/104.3
IC861	1180001070	S.IC TA7805F (TE16L)	T	190.4/23
IC881	1180001920	S.IC TA79L08F (TE12L)	T	215.2/94.1
IC1401	1120002580	S.IC M52338FP	T	66.4/8.1
IC1521	1110003750	S.IC M5218AFP 600C	T	101.9/31.5
Q321	1590002310	S.TR DTC114EE TL	T	220.6/21.3
Q511	1590002310	S.TR DTC114EE TL	B	99.3/29.7
Q512	1520000460	S.TR 2SB1132 T100 R	B	99.5/34.6
Q513	1590002310	S.TR DTC114EE TL	B	94.3/29.7
Q514	1520000460	S.TR 2SB1132 T100 R	B	94.5/34.6
Q515	1590002310	S.TR DTC114EE TL	B	73.9/36.8
Q622	1590002310	S.TR DTC114EE TL	T	225.7/63
Q623	1590002310	S.TR DTC114EE TL	T	211.5/57.5
Q624	1590002310	S.TR DTC114EE TL	T	196/57.5
Q625	1590002310	S.TR DTC114EE TL	T	180.5/57.5
Q801	1530002060	S.TR 2SC4081 T106 R	T	98.5/96.4
Q802	1520000650	S.TR 2SB1201-S-TL	T	99/85.4
Q803	1530003300	S.TR 2SC3647S-TD	T	83.3/85.1
Q804	1530003300	S.TR 2SC3647S-TD	T	67.5/84.7
Q805	1590002310	S.TR DTC114EE TL	T	105.8/99.9
Q821	1530002060	S.TR 2SC4081 T106 R	T	88/65.5
Q841	1520000580	S.TR 2SB1124S-TD	T	115.6/104.7
Q901	1590002310	S.TR DTC114EE TL	T	169/24.1
Q902	1590002310	S.TR DTC114EE TL	T	172.8/24.1
Q903	1590002310	S.TR DTC114EE TL	T	176.8/24.1
Q904	1530002060	S.TR 2SC4081 T106 R	T	172.7/28.7
Q905	1520000650	S.TR 2SB1201-S-TL	T	170.3/35
Q1201	1510000510	S.TR 2SA1576A T106R	T	89.8/29.4
Q1211	1510000510	S.TR 2SA1576A T106R	T	89.9/23.8
Q1221	1510000510	S.TR 2SA1576A T106R	T	90/18.1
Q1551	1530002060	S.TR 2SC4081 T106 R	B	122.2/32.7
Q1552	1510000510	S.TR 2SA1576A T106R	B	125.1/31.1
Q1553	1510000510	S.TR 2SA1576A T106R	B	124.8/34.4
Q1554	1530002060	S.TR 2SC4081 T106 R	B	122.1/30.1
D421	1750000520	S.DIO DAN222TL	T	59.4/68.4
D422	1750000520	S.DIO DAN222TL	T	55.6/71.3
D423	1750000520	S.DIO DAN222TL	T	57.9/74.2

[DISPLAY UNIT]

REF NO.	ORDER NO.	DESCRIPTION	M.	H/V LOCATION
D424	1750000520	S.DIO DAN222TL	T	60.2/74.2
D425	1750000520	S.DIO DAN222TL	T	62.3/74
D431	1750000520	S.DIO DAN222TL	T	64.3/68.4
D432	1750000520	S.DIO DAN222TL	T	65.6/71.1
D501	1750000190	S.DIO 1SS322 (TE85R)	T	119.3/19.7
D509	1750000190	S.DIO 1SS322 (TE85R)	B	62/5.8
D512	1730000410	S.ZEN RD5.1M-T2B2	B	91.6/39.4
D531	1730002260	S.ZEN MA8030-H (TX)	B	74.6/33.5
D701	1750000520	S.DIO DAN222TL	T	214.2/81.7
D801	1730002260	S.ZEN MA8030-H (TX)	T	96.3/96.3
D821	1750000190	S.DIO 1SS322 (TE85R)	T	105.1/60.1
D822	1730001050	S.ZEN RD20M-T2B1	T	92.1/67.7
D841	1750000560	S.DIO RB050L-40 TE-25	T	115.8/100.6
D901	1730000410	S.ZEN RD5.1M-T2B2	T	176.6/31.7
D1201	1730002260	S.ZEN MA8030-H (TX)	T	89.9/27.2
D1211	1730002260	S.ZEN MA8030-H (TX)	T	90/21.6
D1221	1730002260	S.ZEN MA8030-H (TX)	T	90.1/15.9
X401	6050009870	S.XTL CR-567 (9.8304 MHz)	T	71.9/56.6
L321	6200003950	S.COL HF50ACC 322513-T	T	222.6/25.2
L322	6200003950	S.COL HF50ACC 322513-T	T	222/28.6
L323	6200003950	S.COL HF50ACC 322513-T	T	217.7/22.7
L401	6200003950	S.COL HF50ACC 322513-T	B	56.4/70.5
L801	6180000990	COL LAL 04NA 101K	T	102.9/91.8
L802	6190001190	S.COL D10F-A814AY-101K=P3	T	87/97.7
L803	6190001180	S.COL BLC13H-D818HN-1107	T	70.3/97.9
L821	6200003950	S.COL HF50ACC 322513-T	T	110.8/62.8
L822	6200009190	S.COL NLCF565050T-472K	T	109.9/57.7
L823	6200003520	S.COL ELJFB 102K-F	T	91.3/62.6
L841	6190001190	S.COL D10F-A814AY-101K=P3	T	164.4/89.9
L842	6180003250	S.COL SLF12565T-680M2R0	T	119.4/92.5
L843	6190001190	S.COL D10F-A814AY-101K=P3	T	132.2/91.9
R101	7030003320	S.RES ERJ3GEYJ 101 V (100 Ω)	T	40.8/10.4
R102	7030003580	S.RES ERJ3GEYJ 153 V (15 kΩ)	T	38.4/2.9
R103	7030003580	S.RES ERJ3GEYJ 153 V (15 kΩ)	T	38.6/7.9
R104	7030003640	S.RES ERJ3GEYJ 473 V (47 kΩ)	T	29.4/6.7
R105	7030003320	S.RES ERJ3GEYJ 101 V (100 Ω)	T	43.4/12.6
R106	7030003720	S.RES ERJ3GEYJ 224 V (220 kΩ)	T	25.9/13
R107	7030003720	S.RES ERJ3GEYJ 224 V (220 kΩ)	B	27.6/22.8
R121	7030003680	S.RES ERJ3GEYJ 104 V (100 kΩ)	T	50.2/17.2
R122	7030003720	S.RES ERJ3GEYJ 224 V (220 kΩ)	T	48.6/17.2
R123	7030003680	S.RES ERJ3GEYJ 104 V (100 kΩ)	T	48.6/14.5
R124	7030003800	S.RES ERJ3GEYJ 105 V (1 MΩ)	T	49.4/12.6
R125	7030003680	S.RES ERJ3GEYJ 104 V (100 kΩ)	T	44/18
R126	7030003720	S.RES ERJ3GEYJ 224 V (220 kΩ)	T	45.9/17.2
R127	7030003680	S.RES ERJ3GEYJ 104 V (100 kΩ)	T	45.9/14.5
R128	7030003800	S.RES ERJ3GEYJ 105 V (1 MΩ)	T	46.7/12.6
R201	7030003440	S.RES ERJ3GEYJ 102 V (1 kΩ)	B	108.1/30.7
R202	7030003440	S.RES ERJ3GEYJ 102 V (1 kΩ)	B	108/26.8
R203	7030003440	S.RES ERJ3GEYJ 102 V (1 kΩ)	B	106.7/26.3
R204	7030003440	S.RES ERJ3GEYJ 102 V (1 kΩ)	B	106.3/30.1
R205	7030003440	S.RES ERJ3GEYJ 102 V (1 kΩ)	B	105.9/32.8
R206	7030003440	S.RES ERJ3GEYJ 102 V (1 kΩ)	B	105.8/36.1
R207	7030003440	S.RES ERJ3GEYJ 102 V (1 kΩ)	B	105.4/38.8
R208	7030003440	S.RES ERJ3GEYJ 102 V (1 kΩ)	B	105/41.5
R209	7030003440	S.RES ERJ3GEYJ 102 V (1 kΩ)	B	104/36.1
R210	7030003440	S.RES ERJ3GEYJ 102 V (1 kΩ)	B	103.6/38.8
R211	7030003440	S.RES ERJ3GEYJ 102 V (1 kΩ)	B	103.2/41.5
R212	7030003640	S.RES ERJ3GEYJ 473 V (47 kΩ)	B	111.1/27.5
R213	7030003640	S.RES ERJ3GEYJ 473 V (47 kΩ)	B	111.1/31.7
R214	7030003640	S.RES ERJ3GEYJ 473 V (47 kΩ)	B	111/33.8
R215	7030003640	S.RES ERJ3GEYJ 473 V (47 kΩ)	T	108.4/36
R221	7030003440	S.RES ERJ3GEYJ 102 V (1 kΩ)	B	7.5/94.3
R222	7030003440	S.RES ERJ3GEYJ 102 V (1 kΩ)	B	10.2/93.3
R223	7030003440	S.RES ERJ3GEYJ 102 V (1 kΩ)	B	7.5/92.3
R224	7030003440	S.RES ERJ3GEYJ 102 V (1 kΩ)	B	10.2/91.3
R225	7030003440	S.RES ERJ3GEYJ 102 V (1 kΩ)	B	7.5/90.3
R226	7030003440	S.RES ERJ3GEYJ 102 V (1 kΩ)	B	10.2/89.3
R227	7030003440	S.RES ERJ3GEYJ 102 V (1 kΩ)	B	7.5/88.3
R228	7030003440	S.RES ERJ3GEYJ 102 V (1 kΩ)	B	10.2/87.3
R229	7030003440	S.RES ERJ3GEYJ 102 V (1 kΩ)	B	7.5/86.3
R230	7030003440	S.RES ERJ3GEYJ 102 V (1 kΩ)	B	10.2/85.3
R231	7030003440	S.RES ERJ3GEYJ 102 V (1 kΩ)	B	7.5/84.3
R232	7030003440	S.RES ERJ3GEYJ 102 V (1 kΩ)	B	10.2/83.3
R233	7030003440	S.RES ERJ3GEYJ 102 V (1 kΩ)	B	7.5/82.3
R234	7030003440	S.RES ERJ3GEYJ 102 V (1 kΩ)	B	10.2/81.3
R235	7030003440	S.RES ERJ3GEYJ 102 V (1 kΩ)	B	7.5/80.3
R241	7030003440	S.RES ERJ3GEYJ 102 V (1 kΩ)	B	7.5/77.8
R242	7030003440	S.RES ERJ3GEYJ 102 V (1 kΩ)	B	10.2/73.8
R243	7030003440	S.RES ERJ3GEYJ 102 V (1 kΩ)	B	7.5/72.7

M.=Mounted side (T: Mounted on the Top side, B: Mounted on the Bottom side)

S.=Surface mount

[DISPLAY UNIT]

REF NO.	ORDER NO.	DESCRIPTION	M.	H/V LOCATION
R244	7030003440	S.RES ERJ3GEYJ 102 V (1 kΩ)	B	10.2/71.7
R245	7030003440	S.RES ERJ3GEYJ 102 V (1 kΩ)	B	7.5/70.8
R246	7030003440	S.RES ERJ3GEYJ 102 V (1 kΩ)	B	10.2/69.7
R247	7030003440	S.RES ERJ3GEYJ 102 V (1 kΩ)	B	7.5/68.7
R248	7030003440	S.RES ERJ3GEYJ 102 V (1 kΩ)	B	10.2/67.7
R249	7030003440	S.RES ERJ3GEYJ 102 V (1 kΩ)	B	7.5/66.7
R250	7030003440	S.RES ERJ3GEYJ 102 V (1 kΩ)	B	8.3/65.1
R251	7030003440	S.RES ERJ3GEYJ 102 V (1 kΩ)	B	9.1/63.7
R252	7030003440	S.RES ERJ3GEYJ 102 V (1 kΩ)	B	10.2/61.7
R253	7030003440	S.RES ERJ3GEYJ 102 V (1 kΩ)	B	7.5/60.7
R254	7030003440	S.RES ERJ3GEYJ 102 V (1 kΩ)	B	10.5/59.7
R255	7030003440	S.RES ERJ3GEYJ 102 V (1 kΩ)	B	6.8/56.4
R256	7030003440	S.RES ERJ3GEYJ 102 V (1 kΩ)	B	8.3/57.7
R301	7030003440	S.RES ERJ3GEYJ 102 V (1 kΩ)	T	150.3/58
R312	7030003440	S.RES ERJ3GEYJ 102 V (1 kΩ)	T	150.5/63.9
R313	7030003440	S.RES ERJ3GEYJ 102 V (1 kΩ)	T	147.6/59.9
R315	7030003280	S.RES ERJ3GEYJ 470 V (47 Ω)	T	147.6/61.9
R316	7030003280	S.RES ERJ3GEYJ 470 V (47 Ω)	T	147.8/63.9
R317	7030003280	S.RES ERJ3GEYJ 470 V (47 Ω)	T	147.9/66.2
R318	7030003440	S.RES ERJ3GEYJ 102 V (1 kΩ)	T	151.3/68.1
R319	7030003440	S.RES ERJ3GEYJ 102 V (1 kΩ)	T	157.9/68.8
R321	7030003560	S.RES ERJ3GEYJ 103 V (10 kΩ)	T	220.6/23
R401	7030003800	S.RES ERJ3GEYJ 105 V (1 MΩ)	T	71.3/52.4
R402	7030003440	S.RES ERJ3GEYJ 102 V (1 kΩ)	T	77.8/60
R403	7030003680	S.RES ERJ3GEYJ 104 V (100 kΩ)	T	78.3/58
R404	7030003640	S.RES ERJ3GEYJ 473 V (47 kΩ)	B	49.4/57
R405	7030003640	S.RES ERJ3GEYJ 473 V (47 kΩ)	B	51.3/55.5
R406	7030003640	S.RES ERJ3GEYJ 473 V (47 kΩ)	B	51.3/52.2
R407	7030003640	S.RES ERJ3GEYJ 473 V (47 kΩ)	B	51.3/49.6
R408	7030003640	S.RES ERJ3GEYJ 473 V (47 kΩ)	B	54.4/38.5
R409	7030003640	S.RES ERJ3GEYJ 473 V (47 kΩ)	B	55.2/41.7
R410	7030003640	S.RES ERJ3GEYJ 473 V (47 kΩ)	B	53.7/47
R411	7030003640	S.RES ERJ3GEYJ 473 V (47 kΩ)	B	53.4/48.3
R412	7030003640	S.RES ERJ3GEYJ 473 V (47 kΩ)	B	54.4/39.8
R413	7030003640	S.RES ERJ3GEYJ 473 V (47 kΩ)	B	53/41.8
R414	7030003640	S.RES ERJ3GEYJ 473 V (47 kΩ)	B	53/43.1
R415	7030003640	S.RES ERJ3GEYJ 473 V (47 kΩ)	B	53/44.4
R416	7030003640	S.RES ERJ3GEYJ 473 V (47 kΩ)	B	52.9/45.7
R421	7030003440	S.RES ERJ3GEYJ 102 V (1 kΩ)	T	58.9/70.9
R424	7030003440	S.RES ERJ3GEYJ 102 V (1 kΩ)	T	55.9/73.8
R431	7030003480	S.RES ERJ3GEYJ 222 V (2.2 kΩ)	T	57.6/70.9
R432	7030003640	S.RES ERJ3GEYJ 473 V (47 kΩ)	T	63.8/71
R441	7030003560	S.RES ERJ3GEYJ 103 V (10 kΩ)	B	59.6/42
R442	7030003640	S.RES ERJ3GEYJ 473 V (47 kΩ)	B	70.8/40.6
R443	7030003640	S.RES ERJ3GEYJ 473 V (47 kΩ)	B	70.5/38.1
R444	7030003560	S.RES ERJ3GEYJ 103 V (10 kΩ)	B	59.6/43.3
R445	7030003560	S.RES ERJ3GEYJ 103 V (10 kΩ)	B	59.6/40.7
R446	7030003560	S.RES ERJ3GEYJ 103 V (10 kΩ)	B	59.6/39.4
R447	7030003320	S.RES ERJ3GEYJ 101 V (100 Ω)	T	60.2/70.9
R490	7030003630	S.RES ERJ3GEYJ 393 V (39 kΩ)	B	88.8/27.9
R491	7030003640	S.RES ERJ3GEYJ 473 V (47 kΩ)	B	90.4/30.5
R492	7030003560	S.RES ERJ3GEYJ 103 V (10 kΩ)	B	94.5/24.6
R493	7030003440	S.RES ERJ3GEYJ 102 V (1 kΩ)	B	98.3/24.1
R494	7030003680	S.RES ERJ3GEYJ 104 V (100 kΩ)	B	92.1/24
R501	7030003440	S.RES ERJ3GEYJ 102 V (1 kΩ)	B	63.2/12.7
R502	7030003580	S.RES ERJ3GEYJ 153 V (15 kΩ)	B	62.4/10.8
R503	7030003440	S.RES ERJ3GEYJ 102 V (1 kΩ)	T	17.3/89.4
R511	7030003560	S.RES ERJ3GEYJ 103 V (10 kΩ)	B	86.7/37.7
R512	7030003560	S.RES ERJ3GEYJ 103 V (10 kΩ)	B	86.7/36.4
R513	7030003450	S.RES ERJ3GEYJ 122 V (1.2 kΩ)	B	86.7/39.9
R514	7030003430	S.RES ERJ3GEYJ 821 V (820 Ω)	B	101/30.6
R515	7030003560	S.RES ERJ3GEYJ 103 V (10 kΩ)	B	98.8/31.4
R516	7030003590	S.RES ERJ3GEYJ 183 V (18 kΩ)	B	86.7/34.6
R518	7030003720	S.RES ERJ3GEYJ 224 V (220 kΩ)	B	96/30.4
R519	7030003720	S.RES ERJ3GEYJ 224 V (220 kΩ)	B	93.8/31.4
R520	7030003720	S.RES ERJ3GEYJ 224 V (220 kΩ)	T	18.8/69.2
R521	7030003470	S.RES ERJ3GEYJ 182 V (1.8 kΩ)	B	88.8/38.1
R531	7030003470	S.RES ERJ3GEYJ 182 V (1.8 kΩ)	B	74.9/35.1
R532	7030003630	S.RES ERJ3GEYJ 393 V (39 kΩ)	B	76.1/29.3
R533	7030003560	S.RES ERJ3GEYJ 103 V (10 kΩ)	B	74.2/30.4
R541	7030003560	S.RES ERJ3GEYJ 103 V (10 kΩ)	B	67.3/24.8
R544	7030003200	S.RES ERJ3GEYJ 100 V (10 Ω)	B	69.2/22.4
R601	7030003640	S.RES ERJ3GEYJ 473 V (47 kΩ)	T	42.2/64.1
R602	7030003640	S.RES ERJ3GEYJ 473 V (47 kΩ)	T	42.2/62.8
R621	7030003480	S.RES ERJ3GEYJ 222 V (2.2 kΩ)	T	244.5/102.7
R622	7030003540	S.RES ERJ3GEYJ 682 V (6.8 kΩ)	T	219.9/60
R623	7030003480	S.RES ERJ3GEYJ 222 V (2.2 kΩ)	T	210.8/59.8
R624	7030003520	S.RES ERJ3GEYJ 472 V (4.7 kΩ)	T	195.3/59.8
R625	7030003580	S.RES ERJ3GEYJ 153 V (15 kΩ)	T	179.8/59.8
R626	7030009950	S.RES ERJ8GEYJ 681V (680 Ω)	T	227.8/61.9
R627	7030009950	S.RES ERJ8GEYJ 681V (680 Ω)	T	215.1/57.9
R628	7030009950	S.RES ERJ8GEYJ 681V (680 Ω)	T	199.6/57.9
R629	7030009950	S.RES ERJ8GEYJ 681V (680 Ω)	T	184.1/58.5
R701	7210002890	VAR RK161221005J/RV-308	B	217/16
R702	7210002890	VAR RK161221005J/RV-308	B	183.5/16
R703	7030003640	S.RES ERJ3GEYJ 473 V (47 kΩ)	T	216.5/50.4
R704	7030003640	S.RES ERJ3GEYJ 473 V (47 kΩ)	T	215.5/20.8
R705	7030003640	S.RES ERJ3GEYJ 473 V (47 kΩ)	T	182.7/50
R706	7030003640	S.RES ERJ3GEYJ 473 V (47 kΩ)	T	182.7/20
R709	7030003560	S.RES ERJ3GEYJ 103 V (10 kΩ)	T	221.6/42.5
R711	7030003640	S.RES ERJ3GEYJ 473 V (47 kΩ)	T	212/10
R712	7210002630	VAR EVU-FLAE02 B14 (10KB)	B	210.7/5.5
R713	7030003640	S.RES ERJ3GEYJ 473 V (47 kΩ)	T	198/10

M.=Mounted side (T: Mounted on the Top side, B: Mounted on the Bottom side)

[DISPLAY UNIT]

REF NO.	ORDER NO.	DESCRIPTION	M.	H/V LOCATION
R714	7210002630	VAR EVU-FLAE02 B14 (10KB)	B	196.7/5.5
R715	7030003640	S.RES ERJ3GEYJ 473 V (47 kΩ)	T	184/10
R716	7210002630	VAR EVU-FLAE02 B14 (10KB)	B	182.7/5.5
R717	7030003640	S.RES ERJ3GEYJ 473 V (47 kΩ)	T	170/10
R718	7210002630	VAR EVU-FLAE02 B14 (10KB)	B	168.7/5.5
R719	7030003640	S.RES ERJ3GEYJ 473 V (47 kΩ)	T	156/10
R720	7210002630	VAR EVU-FLAE02 B14 (10KB)	B	154.7/5.5
R801	7030003620	S.RES ERJ3GEYJ 333 V (33 kΩ)	T	103/97.6
R802	7030003620	S.RES ERJ3GEYJ 333 V (33 kΩ)	T	104.3/97.6
R803	7030000300	S.RES MCR10EZHJ 220 Ω (221)	T	96.5/99.6
R804	7030003500	S.RES ERJ3GEYJ 332 V (3.3 kΩ)	T	79.9/90.9
R805	7030003500	S.RES ERJ3GEYJ 332 V (3.3 kΩ)	T	79.9/89.6
R806	7030003640	S.RES ERJ3GEYJ 473 V (47 kΩ)	T	104.1/100.4
R807	7030008380	S.RES ERJ1WYJ270U (27 Ω)	T	123.5/62.4
R808	7030008380	S.RES ERJ1WYJ270U (27 Ω)	T	119.3/62.4
R821	7030003450	S.RES ERJ3GEYJ 122 V (1.2 kΩ)	T	98.1/61.4
R824	7030003560	S.RES ERJ3GEYJ 103 V (10 kΩ)	T	90.8/65.1
R841	7030009740	S.RES ERJ12RQJ0R33U (0.33 Ω)	T	149.2/105.9
R842	7030009740	S.RES ERJ12RQJ0R33U (0.33 Ω)	T	149.2/105.9
R845	7030006580	S.RES RR0816P-122-D (1.2 kΩ)	T	129.4/99.6
R848	7030006260	S.RES ERJ12YJ471U (470 Ω)	T	123.1/104.8
R849	7030006260	S.RES ERJ12YJ471U (470 Ω)	T	123.1/101.1
R850	7030003380	S.RES ERJ3GEYJ 331 V (330 Ω)	T	118.9/105.5
R861	7030007120	S.RES ERJ1WYJ120U (12 Ω)	T	183/27.3
R862	7030007120	S.RES ERJ1WYJ120U (12 Ω)	T	206.2/23.1
R863	7030007120	S.RES ERJ1WYJ120U (12 Ω)	T	210.4/23.1
R881	7030006140	S.RES ERJ1WYJ560U (56 Ω)	T	201.2/88.1
R882	7030006140	S.RES ERJ1WYJ560U (56 Ω)	T	201.2/91.9
R904	7030003520	S.RES ERJ3GEYJ 472 V (4.7 kΩ)	T	169/26.7
R905	7030003540	S.RES ERJ3GEYJ 682 V (6.8 kΩ)	T	172.8/26.3
R906	7030003580	S.RES ERJ3GEYJ 153 V (15 kΩ)	T	176.8/26.3
R907	7030003580	S.RES ERJ3GEYJ 153 V (15 kΩ)	T	176.8/28
R908	7030003520	S.RES ERJ3GEYJ 472 V (4.7 kΩ)	T	168.8/29.3
R909	7030003400	S.RES ERJ3GEYJ 471 V (470 Ω)	T	176.8/29.3
R910	7030000350	S.RES MCR10EZHJ 560 Ω (561)	T	174.7/34.9
R912	7030009950	S.RES ERJ8GEYJ 681V (680 Ω)	T	202.4/99.4
R914	7030009950	S.RES ERJ8GEYJ 681V (680 Ω)	T	193.6/99.4
R915	7030003560	S.RES ERJ3GEYJ 103 V (10 kΩ)	T	168.8/28
R916	7030003480	S.RES ERJ3GEYJ 222 V (2.2 kΩ)	T	189.5/66.2
R917	7030003520	S.RES ERJ3GEYJ 472 V (4.7 kΩ)	T	181.4/70.3
R1101	7030003640	S.RES ERJ3GEYJ 473 V (47 kΩ)	T	58.9/9.6
R1103	7030003560	S.RES ERJ3GEYJ 103 V (10 kΩ)	T	57.3/19.7
R1104	7030003600	S.RES ERJ3GEYJ 223 V (22 kΩ)	T	57.3/17
R1106	7030003590	S.RES ERJ3GEYJ 183 V (18 kΩ)	T	71.3/19.7
R1107	7030003570	S.RES ERJ3GEYJ 123 V (12 kΩ)	T	71.3/17
R1109	7030003670	S.RES ERJ3GEYJ 223 V (82 kΩ)	T	74.4/19.7
R1110	7030003600	S.RES ERJ3GEYJ 223 V (22 kΩ)	T	74.4/17
R1112	7030003620	S.RES ERJ3GEYJ 333 V (33 kΩ)	T	63.4/19.7
R1113	7030003610	S.RES ERJ3GEYJ 273 V (27 kΩ)	T	63.4/17
R1121	7030003610	S.RES ERJ3GEYJ 273 V (27 kΩ)	T	62.1/19.7
R1122	7030003520	S.RES ERJ3GEYJ 472 V (4.7 kΩ)	T	62.1/17
R1127	7030003670	S.RES ERJ3GEYJ 223 V (82 kΩ)	T	72.6/19.7
R1128	7030003600	S.RES ERJ3GEYJ 223 V (22 kΩ)	T	72.6/17
R1201	7030003340	S.RES ERJ3GEYJ 151 V (150 Ω)	T	87/30.2
R1202	7030003450	S.RES ERJ3GEYJ 122 V (1.2 kΩ)	T	86.9/27.5
R1203	7030003490	S.RES ERJ3GEYJ 272 V (2.7 kΩ)	T	90/25.7
R1211	7030003340	S.RES ERJ3GEYJ 151 V (150 Ω)	T	87/25.6
R1212	7030003450	S.RES ERJ3GEYJ 122 V (1.2 kΩ)	T	87/21.6
R1213	7030003490	S.RES ERJ3GEYJ 272 V (2.7 kΩ)	T	90/20
R1221	7030003340	S.RES ERJ3GEYJ 151 V (150 Ω)	T	87/19
R1222	7030003450	S.RES ERJ3GEYJ 122 V (1.2 kΩ)	T	87/17.7
R1223	7030003490	S.RES ERJ3GEYJ 272 V (2.7 kΩ)	T	88.7/14.3
R1526	7030003320	S.RES ERJ3GEYJ 101 V (100 Ω)	T	104.5/27.5
R1527	7030003320	S.RES ERJ3GEYJ 101 V (100 Ω)	T	99/27.2
R1541	7030003560	S.RES ERJ3GEYJ 103 V (10 kΩ)	T	106.5/28.6
R1542	7030003600	S.RES ERJ3GEYJ 223 V (22 kΩ)	T	107.8/31.4
R1543	7030003600	S.RES ERJ3GEYJ 223 V (22 kΩ)	T	106.5/31.4
R1544	7030003480	S.RES ERJ3GEYJ 183 V (18 kΩ)	T	106.5/34.1
R1545	7030003480	S.RES ERJ3GEYJ 222 V (2.2 kΩ)	T	107.9/34.1
R1551	7030003320	S.RES ERJ3GEYJ 101 V (100 Ω)	B	119.2/38.9
R1552	7030003320	S.RES ERJ3GEYJ 101 V (100 Ω)	B	125.7/36.5
R1553	7030003720	S.RES ERJ3GEYJ 224 V (220 kΩ)	B	119.9/31
R1554	7030003720	S.RES ERJ3GEYJ 224 V (220 kΩ)	B	119.9/34.2
R1555	7030003600	S.RES ERJ3GEYJ 223 V (22 kΩ)	B	122.1/34.6
R1556	7030003600	S.RES ERJ3GEYJ 223 V (22 kΩ)	B	124.8/29.2
R1560	7030003530	S.RES ERJ3GEYJ 562 V (5.6 kΩ)	B	127.1/30.2
R1561	7030003610	S.RES ERJ3GEYJ 273 V (27 kΩ)	B	126.8/34.6
C101	4030011600	S.CER C1608 JB 1E 104K-T	T	38.1/11.1
C102	4030006860	S.CER C1608 JB 1H 102K-T	T	39.7/2.9
C103	4030006860	S.CER C1608 JB 1H 102K-T	T	39.9/7.9
C104	4030006860	S.CER C1608 JB 1H 102K-T	T	29.4/4
C105	4030011600	S.CER C1608 JB 1E 104K-T	T	41.5/7.9
C121</				

[DISPLAY UNIT]

REF NO.	ORDER NO.	DESCRIPTION	M.	H/V LOCATION
C403	4030011600	S.CER C1608 JB 1E 104K-T	B	49.4/39.7
C404	4030011600	S.CER C1608 JB 1E 104K-T	T	58.8/55.7
C405	4030011600	S.CER C1608 JB 1E 104K-T	T	74.2/48.6
C406	4510006650	S.ELE ECEV1EA100SR	T	57.8/59.3
C411	4030011600	S.CER C1608 JB 1E 104K-T	T	61.5/71.4
C431	4030011600	S.CER C1608 JB 1E 104K-T	T	65.7/73.6
C490	4030011600	S.CER C1608 JB 1E 104K-T	B	96.4/24
C491	4030007020	S.CER C1608 CH 1H 120J-T	B	92/26.9
C492	4030006880	S.CER C1608 JB 1H 472K-T	B	90.1/29.2
C501	4510006650	S.ELE ECEV1EA100SR	T	119.7/29.9
C502	4030011600	S.CER C1608 JB 1E 104K-T	T	121.8/26.3
C503	4030011600	S.CER C1608 JB 1E 104K-T	T	121.5/18.5
C504	4510005310	S.ELE ECEV1CA220SR	T	122.9/14.9
C505	4030006880	S.CER C1608 JB 1H 472K-T	T	24.3/66.3
C506	4030006880	S.CER C1608 JB 1H 472K-T	T	25.4/94.3
C513	4030011600	S.CER C1608 JB 1E 104K-T	B	86.7/33.1
C520	4510005810	S.ELE ECEV1HAR47R	T	23.2/59.9
C521	4030006880	S.CER C1608 JB 1H 472K-T	T	26.7/62
C522	4030006880	S.CER C1608 JB 1H 472K-T	T	20.1/69.2
C531	4030006880	S.CER C1608 JB 1H 472K-T	B	74.9/31.7
C542	4030011600	S.CER C1608 JB 1E 104K-T	B	69.2/23.7
C545	4510006650	S.ELE ECEV1EA100SR	T	73.2/25.4
C601	4030006880	S.CER C1608 JB 1H 472K-T	T	45.8/64.1
C602	4030006880	S.CER C1608 JB 1H 472K-T	T	45.8/62.8
C603	4030006860	S.CER C1608 JB 1H 102K-T	T	42.3/61.5
C604	4030006860	S.CER C1608 JB 1H 102K-T	T	42.3/60.2
C605	4030006860	S.CER C1608 JB 1H 102K-T	T	42.3/58.9
C606	4030006860	S.CER C1608 JB 1H 102K-T	T	42.3/57.6
C621	4030011600	S.CER C1608 JB 1E 104K-T	T	225.5/59.8
C701	4030011600	S.CER C1608 JB 1E 104K-T	T	213.8/51.3
C702	4030011600	S.CER C1608 JB 1E 104K-T	T	214.7/22.7
C703	4030006880	S.CER C1608 JB 1H 472K-T	T	179/50
C704	4030006880	S.CER C1608 JB 1H 472K-T	T	187.5/18.5
C711	4030006880	S.CER C1608 JB 1H 472K-T	T	209/10
C712	4030006880	S.CER C1608 JB 1H 472K-T	T	195/10
C713	4030006880	S.CER C1608 JB 1H 472K-T	T	181/10
C714	4030006880	S.CER C1608 JB 1H 472K-T	T	167/10
C715	4030006880	S.CER C1608 JB 1H 472K-T	T	153/10
C801	4510006650	S.ELE ECEV1EA100SR	T	100.5/101.2
C802	4510006650	S.ELE ECEV1EA100SR	T	92.2/89.6
C803	4510006230	S.ELE ECEV1EA470UP	T	90.3/82.9
C804	4340000170	S.MLR MMX-E 2A 473J	T	75.2/84
C805	4030016880	S.CER C4520 CH 3F 150KTA	T	61.5/88.8
C821	4030011600	S.CER C1608 JB 1E 104K-T	T	101.6/68
C822	4510006230	S.ELE ECEV1EA470UP	T	109/68.3
C823	4030006880	S.CER C1608 JB 1H 472K-T	T	89.7/70.6
C824	4030006880	S.CER C1608 JB 1H 472K-T	T	97.1/64.5
C825	4030006880	S.CER C1608 JB 1H 472K-T	T	94.3/65.9
C826	4510005360	S.ELE ECEV1HA4R7SR	T	100.9/57.8
C827	4510005360	S.ELE ECEV1HA4R7SR	T	95/57.8
C828	4510006650	S.ELE ECEV1EA100SR	T	86.1/69.8
C829	4510005360	S.ELE ECEV1HA4R7SR	T	87.5/57.8
C830	4510006650	S.ELE ECEV1EA100SR	T	96.8/70.6
C841	4510006240	S.ELE ECEV1CA221P	T	153.1/95
C842	4030011600	S.CER C1608 JB 1E 104K-T	T	147.1/98.3
C843	4030010760	S.CER C1608 CH 1H 331J-T	T	126.9/103
C844	4510006240	S.ELE ECEV1CA221P	T	125.5/81.1
C845	4030011600	S.CER C1608 JB 1E 104K-T	T	129.4/100.9
C846	4510006240	S.ELE ECEV1CA221P	T	181.1/89.2
C847	4510006240	S.ELE ECEV1CA221P	T	137.1/81.1
C848	4030011600	S.CER C1608 JB 1E 104K-T	T	138.9/92.5
C849	4510006240	S.ELE ECEV1CA221P	T	153.1/85.7
C850	4510006240	S.ELE ECEV1CA221P	T	181.1/98.6
C861	4510006650	S.ELE ECEV1EA100SR	T	201/22.7
C862	4030011600	S.CER C1608 JB 1E 104K-T	T	197.4/21.2
C863	4030011600	S.CER C1608 JB 1E 104K-T	T	197.4/24.8
C864	4510005310	S.ELE ECEV1CA220SR	T	192.5/30.2
C881	4510006650	S.ELE ECEV1EA100SR	T	208.5/93
C882	4030011600	S.CER C1608 JB 1E 104K-T	T	212/91.4
C883	4030011600	S.CER C1608 JB 1E 104K-T	T	218.4/92.8
C884	4510005310	S.ELE ECEV1CA220SR	T	222/93.6
C901	4510005360	S.ELE ECEV1HA4R7SR	T	186.1/69.9
C921	4030006880	S.CER C1608 JB 1H 472K-T	T	229.9/48
C922	4030006880	S.CER C1608 JB 1H 472K-T	T	225.2/48
C1101	4030011600	S.CER C1608 JB 1E 104K-T	T	58.9/3
C1102	4030011600	S.CER C1608 JB 1E 104K-T	T	777
C1103	4030011600	S.CER C1608 JB 1E 104K-T	T	74.2/9.3
C1104	4030011600	S.CER C1608 JB 1E 104K-T	T	58.9/8.3
C1105	4030011600	S.CER C1608 JB 1E 104K-T	T	72.9/2.1
C1106	4030011600	S.CER C1608 JB 1E 104K-T	T	74.2/10.9
C1107	4030011600	S.CER C1608 JB 1E 104K-T	T	58.9/4.3
C1108	4030011600	S.CER C1608 JB 1E 104K-T	B	69.2/11.1
C1109	4030011600	S.CER C1608 JB 1E 104K-T	T	77/8.5
C1110	4030011600	S.CER C1608 JB 1E 104K-T	T	74.2/12.5
C1201	4030011600	S.CER C1608 JB 1E 104K-T	T	87/28.8
C1211	4030011600	S.CER C1608 JB 1E 104K-T	T	87.8/23.5
C1221	4030011600	S.CER C1608 JB 1E 104K-T	T	87/16.4
C1307	4030011600	S.CER C1608 JB 1E 104K-T	B	67.6/6.4
C1308	4030011600	S.CER C1608 JB 1E 104K-T	B	72/6.3
C1309	4030011600	S.CER C1608 JB 1E 104K-T	B	68.4/8.6
C1401	4030011600	S.CER C1608 JB 1E 104K-T	T	58.9/5.6
C1402	4030011600	S.CER C1608 JB 1E 104K-T	T	58.9/7
C1403	4030011600	S.CER C1608 JB 1E 104K-T	T	73.8/14.1

M.=Mounted side (T: Mounted on the Top side, B: Mounted on the Bottom side)

[DISPLAY UNIT]

REF NO.	ORDER NO.	DESCRIPTION	M.	H/V LOCATION
C1404	4030011600	S.CER C1608 JB 1E 104K-T	T	58.9/13.5
C1405	4030011600	S.CER C1608 JB 1E 104K-T	T	58.9/12.2
C1406	4030011600	S.CER C1608 JB 1E 104K-T	T	58.9/10.9
C1407	4030011600	S.CER C1608 JB 1E 104K-T	T	77/13.3
C1408	4030011600	S.CER C1608 JB 1E 104K-T	T	77/11.7
C1409	4030011600	S.CER C1608 JB 1E 104K-T	T	77/10.1
C1521	4030011600	S.CER C1608 JB 1E 104K-T	T	103.2/27.5
C1522	4030011600	S.CER C1608 JB 1E 104K-T	T	101.9/27.5
C1541	4510006650	S.ELE ECEV1EA100SR	T	111.5/31
C1551	4510006650	S.ELE ECEV1EA100SR	T	134.3/29.9
C1552	4510006650	S.ELE ECEV1EA100SR	T	134/33.4
C1553	4510006650	S.ELE ECEV1EA100SR	T	119.8/35.9
C1554	4510006650	S.ELE ECEV1EA100SR	T	127.2/35.9
C1555	4030011600	S.CER C1608 JB 1E 104K-T	B	129.7/30.4
C1556	4030011600	S.CER C1608 JB 1E 104K-T	B	130/35.4
J101	6510003400	CNR B04B-EH-S	T	25.3/17
J120	6510022620	S.CNR 10FMN-BMTR-A-TBT	T	24.3/36
J201	6510022610	S.CNR 16FMN-BMTR-A-TBT	T	109.6/16.7
J221	6510022610	S.CNR 16FMN-BMTR-A-TBT	T	6.3/86.8
J241	6510022580	S.CNR 24FMN-BMTR-A-TBT	T	6.3/63.2
J301	6510022580	S.CNR 24FMN-BMTR-A-TBT	T	163/61.4
J321	6510022580	S.CNR 24FMN-BMTR-A-TBT	T	193/39.9
J322	6510022620	S.CNR 10FMN-BMTR-A-TBT	T	227.9/17.9
J451	6510003400	CNR B04B-EH-S	T	238/103.6
J452	6510003390	CNR B03B-EH-S	T	233.5/103.6
J531	6510022580	S.CNR 24FMN-BMTR-A-TBT	T	22.5/81.7
J601	6510022620	S.CNR 10FMN-BMTR-A-TBT	T	36.8/60
J801	6510018960	S.CNR B2B-PH-SM3-TB	T	49.9/91.3
J802	6510018960	S.CNR B2B-PH-SM3-TB	T	143/31.9
J921	6510022620	S.CNR 10FMN-BMTR-A-TBT	T	227.6/40.1
J941	6510022620	S.CNR 10FMN-BMTR-A-TBT	T	244.3/82.4
DS621	5040002110	S.LED CL-200HR-C-TU	B	244.5/102.7
DS622	5040002080	S.LED CL-200YG-C-TU	B	226.7/55.6
DS623	5040002080	S.LED CL-200YG-C-TU	B	211.2/55.6
DS624	5040002080	S.LED CL-200YG-C-TU	B	195.7/55.6
DS625	5040002080	S.LED CL-200YG-C-TU	B	180.2/55.6
DS901	5040002830	S.LED NSCW100	B	206.8/93.5
DS904	5040002830	S.LED NSCW100	B	193.6/93.5
S621	2260001890	S.SW SKQDPA	B	244.5/98.3
S622	2260001890	S.SW SKQDPA	B	244.5/82.8
S623	2260001890	S.SW SKQDPA	B	222.5/56
S624	2260001890	S.SW SKQDPA	B	207/56
S625	2260001890	S.SW SKQDPA	B	191.5/56
S626	2260001890	S.SW SKQDPA	B	176/56
W502	7030003860	S.RES ERJ3GE JPW V	T	16.4/79.4
W504	7030003860	S.RES ERJ3GE JPW V	T	16.4/76.8
W506	7030003860	S.RES ERJ3GE JPW V	T	26.2/65.5
W512	7030003860	S.RES ERJ3GE JPW V	B	82.8/28.1
W801	7030008240	S.RES ERJ12YJ0R00U	T	50.8/76.1
EP1	0910054522	PCB B 5757B		

S.=Surface mount

[TEN-KEY UNIT]

REF NO.	ORDER NO.	DESCRIPTION	M.	H/V LOCATION
Q1	1590002310	S.TR DTC114EE TL	B	61.8/50.6
Q2	1590002310	S.TR DTC114EE TL	B	8.3/45.1
Q3	1590002310	S.TR DTC114EE TL	B	13.8/51.8
Q4	1590002310	S.TR DTC114EE TL	B	100/71.7
Q5	1590002310	S.TR DTC114EE TL	B	74.8/72.5
R1	7030003540	S.RES ERJ3GEYJ 682 V (6.8 kΩ)	B	9.8/93.5
R2	7030003480	S.RES ERJ3GEYJ 222 V (2.2 kΩ)	B	9.7/88.8
R3	7030003520	S.RES ERJ3GEYJ 472 V (4.7 kΩ)	B	9.7/779
R4	7030003580	S.RES ERJ3GEYJ 153 V (15 kΩ)	B	9.7/69.6
R5	7030003540	S.RES ERJ3GEYJ 682 V (6.8 kΩ)	B	74/42.4
R6	7030003480	S.RES ERJ3GEYJ 222 V (2.2 kΩ)	B	84/42.6
R7	7030003520	S.RES ERJ3GEYJ 472 V (4.7 kΩ)	B	95.5/42.7
R8	7030003530	S.RES ERJ3GEYJ 562 V (5.6 kΩ)	B	64.1/50.4
R9	7030003530	S.RES ERJ3GEYJ 562 V (5.6 kΩ)	B	6/45
R10	7030003420	S.RES ERJ3GEYJ 681 V (680 Ω)	B	11.5/51.6
R11	7030003440	S.RES ERJ3GEYJ 102 V (1 kΩ)	B	102.2/71.7
R12	7030003440	S.RES ERJ3GEYJ 102 V (1 kΩ)	B	77.1/71.7
C1	4030011600	S.CER C1608 JB 1E 104K-T	B	20.9/65.6
C2	4030011600	S.CER C1608 JB 1E 104K-T	B	20.9/67.4
J1	6510022610	S.CNR 16FMN-BMTR-A-TBT	B	42.2/88.3
J2	6510022580	S.CNR 24FMN-BMTR-A-TBT	B	42.2/64.7
DS1	5040002110	S.LED CL-200HR-C-TU	T	64.1/49.5
DS2	5040002110	S.LED CL-200HR-C-TU	T	4.4/49.5
DS3	5040002220	S.LED CL-220YG-C-TU	T	9.8/56
DS4	5040002220	S.LED CL-220YG-C-TU	T	102.2/76.8
DS5	5040002220	S.LED CL-220YG-C-TU	T	77.2/76.8
S1	2260001890	S.SW SKQDPA	T	6/103.2
S2	2260001890	S.SW SKQDPA	T	6/93.6
S3	2260001890	S.SW SKQDPA	T	6/84
S4	2260001890	S.SW SKQDPA	T	6/74.4
S5	2260001890	S.SW SKQDPA	T	6/64.8
S6	2260001890	S.SW SKQDPA	T	19.9/103.7
S7	2260001890	S.SW SKQDPA	T	19.9/95.1
S8	2260001890	S.SW SKQDPA	T	19.9/86.5
S9	2260001890	S.SW SKQDPA	T	19.9/77.9
S10	2260001890	S.SW SKQDPA	T	34.2/103.7
S11	2260001890	S.SW SKQDPA	T	34.2/95.1
S12	2260001890	S.SW SKQDPA	T	34.2/86.5
S13	2260001890	S.SW SKQDPA	T	34.2/77.9
S14	2260001890	S.SW SKQDPA	T	48.5/103.7
S15	2260001890	S.SW SKQDPA	T	48.5/95.1
S16	2260001890	S.SW SKQDPA	T	48.5/86.5
S17	2260001890	S.SW SKQDPA	T	48.5/77.9
S18	2260001890	S.SW SKQDPA	T	62.5/103.7
S19	2260001890	S.SW SKQDPA	T	62.5/95.1
S20	2260001890	S.SW SKQDPA	T	62.5/86.5
S21	2260001890	S.SW SKQDPA	T	62.5/77.9
S22	2260001890	S.SW SKQDPA	T	62.5/68.8
S23	2260001890	S.SW SKQDPA	T	62.5/59.2
S24	2260001890	S.SW SKQDPA	T	81.5/76.8
S25	2260001890	S.SW SKQDPA	T	97.9/76.8
S26	2260001890	S.SW SKQDPA	T	78.2/38.1
S27	2260001890	S.SW SKQDPA	T	89.7/38.1
S28	2260001890	S.SW SKQDPA	T	101.2/38.1
S29	2260001890	S.SW SKQDPA	T	23.1/68.8
S30	2260001890	S.SW SKQDPA	T	45.3/68.8
S31	2260001890	S.SW SKQDPA	T	64.2/4.2
EP1	0910052273	PCB B 5403C		

M.=Mounted side (T: Mounted on the Top side, B: Mounted on the Bottom side)

[MODE UNIT]

REF NO.	ORDER NO.	DESCRIPTION	M.	H/V LOCATION
R1	7030003540	S.RES ERJ3GEYJ 682 V (6.8 kΩ)	B	11.9/94.8
R2	7030003480	S.RES ERJ3GEYJ 222 V (2.2 kΩ)	B	11.1/85.7
R3	7030003520	S.RES ERJ3GEYJ 472 V (4.7 kΩ)	B	11.1/75.6
R4	7030003580	S.RES ERJ3GEYJ 153 V (15 kΩ)	B	11.1/65.7
R5	7030003540	S.RES ERJ3GEYJ 682 V (6.8 kΩ)	B	11.9/54.9
R6	7030003480	S.RES ERJ3GEYJ 222 V (2.2 kΩ)	B	11.1/45.7
R7	7030003520	S.RES ERJ3GEYJ 472 V (4.7 kΩ)	B	11.1/35.6
C1	4030011600	S.CER C1608 JB 1E 104K-T	B	11.9/97
C2	4030011600	S.CER C1608 JB 1E 104K-T	B	11.9/47.7
J1	6510022610	S.CNR 16FMN-BMTR-A-TBT	B	61.6/8.5
S1	2260001890	S.SW SKQDPA	T	37.2/14.3
S2	2260001890	S.SW SKQDPA	T	57/14.3
S3	2260001890	S.SW SKQDPA	T	76.8/14.3
S4	2260001890	S.SW SKQDPA	T	96.6/14.3
S5	2260001890	S.SW SKQDPA	T	116.4/14.3
S6	2260001890	S.SW SKQDPA	T	37.2/4.7
S7	2260001890	S.SW SKQDPA	T	57/4.7
S8	2260001890	S.SW SKQDPA	T	76.8/4.7
S9	2260001890	S.SW SKQDPA	T	96.6/4.7
S10	2260001890	S.SW SKQDPA	T	116.4/4.7
S11	2260001890	S.SW SKQDPA	T	139.8/5.2
S12	2260001890	S.SW SKQDPA	T	12.3/94.8
S13	2260001890	S.SW SKQDPA	T	12.3/84.8
S14	2260001890	S.SW SKQDPA	T	12.3/74.8
S15	2260001890	S.SW SKQDPA	T	12.3/64.8
S16	2260001890	S.SW SKQDPA	T	12.3/54.8
S17	2260001890	S.SW SKQDPA	T	12.3/44.8
S18	2260001890	S.SW SKQDPA	T	12.3/34.8
EP1	0910052293	PCB B 5404C		

[PBT UNIT]

REF NO.	ORDER NO.	DESCRIPTION	M.	H/V LOCATION
R1	7210002970	VAR RV-314 (RK0972210 10KB/10KB)	T	6/20
R3	7030003640	S.RES ERJ3GEYJ 473 V (47 kΩ)	B	13.3/14.9
R4	7030003640	S.RES ERJ3GEYJ 473 V (47 kΩ)	B	14.2/12.3
C1	4030006880	S.CER C1608 JB 1H 472K-T	B	16.5/13.1
C2	4030006880	S.CER C1608 JB 1H 472K-T	B	14.9/14.9
J1	6510022620	S.CNR 10FMN-BMTR-A-TBT	B	10.3/6
S1	2250000410	ECR TP90D96E20-30F-2178-1	T	44/20
EP1	0910051852	PCB B 5330B		

[RIT UNIT]

REF NO.	ORDER NO.	DESCRIPTION	M.	H/V LOCATION
J1	6510022620	S.CNR 10FMN-BMTR-A-TBT	B	11/7
S1	2250000340	ECR EVQ-VCJF0324B	T	11/20.8
EP1	0910052301	PCB B 5405A		

S.=Surface mount

[PHONE UNIT]

REF NO.	ORDER NO.	DESCRIPTION	M.	H/V LOCATION
L1	6200003950	S.COL HF50ACC 322513-T	B	15.1/5.9
L2	6200003950	S.COL HF50ACC 322513-T	B	10/7
R1	7030006240	S.RES ERJ12YJ181U (180 Ω)	B	6.2/20.1
R2	7030006240	S.RES ERJ12YJ181U (180 Ω)	B	13.8/20.1
C1	4030006880	S.CER C1608 JB 1H 472K-T	B	13/3.1
C2	4030006880	S.CER C1608 JB 1H 472K-T	B	8.5/3.4
J1	6510022620	S.CNR 10FMN-BMTTR-A-TBT	T	11.5/3.3
J2	6450001980	CNR HLJ5815-01-030	T	10/30.5
EP1	0910052283	PCB B 5331C		

[PLL UNIT]

REF NO.	ORDER NO.	DESCRIPTION	M.	H/V LOCATION
IC1	1130007700	S.IC BU4094BCF-E2	T	113.7/69.9
IC101	1140007880	S.IC TC190G08AF-0046-Z/SC-1246A	T	106.9/89.7
IC102	1130003830	S.IC TC7S04F (TE85R)	T	93.1/92
IC191	1130006440	S.IC TC7S08F (TE85R)	T	118.3/79.6
IC192	1130006440	S.IC TC7S08F (TE85R)	T	96.4/72.5
IC320	1110001890	S.IC μPC1678G-E2	T	40.1/63.4
IC381	1130009230	S.IC LMX2306TMX	T	29.7/68.9
IC382	1180000420	S.IC TA78L05F (TE12R)	T	54.6/70.2
IC401	1140007880	S.IC TC190G08AF-0046-Z/SC-1246A	T	104.1/13.6
IC402	1130003830	S.IC TC7S04F (TE85R)	T	90.5/9.5
IC620	1110001890	S.IC μPC1678G-E2	T	40.1/46.9
IC681	1130009230	S.IC LMX2306TMX	T	30.9/40.5
IC682	1180000420	S.IC TA78L05F (TE12R)	T	52.9/40.6
IC701	1140004550	S.IC M65343FP/SC1287	T	138.4/35.8
IC801	1140004550	S.IC M65343FP/SC1287	T	130.9/13.1
IC901	1130007660	S.IC LC7153M-TLM	T	100.3/46.3
IC902	1130006800	S.IC TC7W08F (TE12L)	B	102.1/43
Q2	1590002420	S.TR UMD3N TR	T	100.7/71
Q51	1530002560	S.TR 2SC4403-3-TL	T	142.9/85.7
Q52	1530002060	S.TR 2SC4081 T106 R	T	130.1/98.5
Q71	1530002060	S.TR 2SC4081 T106 R	T	128.1/106.8
Q81	1530002570	S.TR 2SC4405-3-TL	B	133.4/103.2
Q102	1530002060	S.TR 2SC4081 T106 R	T	95/83.4
Q103	1530002060	S.TR 2SC4081 T106 R	T	118.6/89.2
Q121	1590002420	S.TR UMD3N TR	T	83/107.7
Q122	1590002420	S.TR UMD3N TR	T	83/104.5
Q123	1590002420	S.TR UMD3N TR	T	84.1/101.3
Q124	1590002420	S.TR UMD3N TR	T	85.8/92.6
Q126	1590002420	S.TR UMD3N TR	T	84.2/98.1
Q151	1560000330	S.FET 2SK210-GR (TE85R)	T	63.7/68.9
Q152	1530002060	S.TR 2SC4081 T106 R	T	68/64.6
Q181	1530002060	S.TR 2SC4081 T106 R	T	50.6/77.7
Q201	1560000490	S.FET 2SK508 K52 T2B	T	74.1/96.5
Q202	1530003090	S.TR 2SC4213-B (TE85R)	T	73.5/102.1
Q221	1560000490	S.FET 2SK508 K52 T2B	T	57.2/96.5
Q222	1530003090	S.TR 2SC4213-B (TE85R)	T	56.7/102.1
Q251	1560000490	S.FET 2SK508 K52 T2B	T	40.1/96.5
Q252	1530003090	S.TR 2SC4213-B (TE85R)	T	39.9/102.1
Q271	1560000490	S.FET 2SK508 K52 T2B	T	23.1/96.5
Q272	1530003090	S.TR 2SC4213-B (TE85R)	T	23.1/102.1
Q301	1530002560	S.TR 2SC4403-3-TL	T	42.1/76.8
Q351	1590001870	S.TR DTA114EE TL	T	3.6/61.4
Q361	1590002310	S.TR DTC114EE TL	B	10.8/79.5
Q402	1530002060	S.TR 2SC4081 T106 R	T	93.2/20.9
Q403	1530002060	S.TR 2SC4081 T106 R	T	116.4/10
Q421	1590002420	S.TR UMD3N TR	T	82/2.8
Q422	1590002420	S.TR UMD3N TR	T	81.6/5.6
Q423	1590002420	S.TR UMD3N TR	T	82.3/8.6
Q424	1590002420	S.TR UMD3N TR	T	83/15.3
Q426	1590002420	S.TR UMD3N TR	T	82.4/11.7
Q451	1560000330	S.FET 2SK210-GR (TE85R)	T	68.9/43.7
Q452	1530002060	S.TR 2SC4081 T106 R	T	69.8/34.5
Q481	1530002060	S.TR 2SC4081 T106 R	T	54.1/32.5
Q501	1560000490	S.FET 2SK508 K52 T2B	T	30.8/13.4
Q502	1530003090	S.TR 2SC4213-B (TE85R)	T	31.2/7.9
Q521	1560000490	S.FET 2SK508 K52 T2B	T	14/13.5
Q522	1530003090	S.TR 2SC4213-B (TE85R)	T	14.3/7.9
Q551	1560000490	S.FET 2SK508 K52 T2B	T	47.6/13.4
Q552	1530003090	S.TR 2SC4213-B (TE85R)	T	47.9/7.9
Q571	1560000490	S.FET 2SK508 K52 T2B	T	64.5/13.5
Q572	1530003090	S.TR 2SC4213-B (TE85R)	T	64.7/7.9
Q601	1530002560	S.TR 2SC4403-3-TL	T	41.7/34.9
Q651	1590001870	S.TR DTA114EE TL	T	4.1/45.9
Q661	1590002310	S.TR DTC114EE TL	B	1.7/32.6
Q681	1510000510	S.TR 2SA1576A T106R	B	39.9/43.7
Q701	1530002060	S.TR 2SC4081 T106 R	B	143.8/34.7
Q801	1530002060	S.TR 2SC4081 T106 R	T	124.5/5.2
Q802	1530003010	S.TR 2SC4117-GR (TE85R)	T	150.9/16
Q902	1560000490	S.FET 2SK508 K52 T2B	T	109/47.1
Q903	1530003010	S.TR 2SC4117-GR (TE85R)	T	110.3/40
Q904	1530002370	S.TR 2SC2714-O (TE85R)	T	115.7/42.5
Q905	1590002310	S.TR DTC114EE TL	T	117.6/50.6
Q906	1590000980	S.TR DTB123EK T146	T	119.6/52.2
Q907	1590002310	S.TR DTC114EE TL	T	117.5/48.5
D2	1160000140	S.DIO DAP222 TL	T	99.9/68.4
D3	1750000520	S.DIO DAN222TL	T	103.2/72.8
D4	1750000520	S.DIO DAN222TL	T	103.1/70.7
D51	1720000830	S.VCP KV1770STL	B	139.2/90.2
D151	1720000590	S.VCP MA357 (TX)	T	73.1/78.1
D152	1790000490	S.DIO HSM88AS-TR	T	65.6/77.4
D153	1790000490	S.DIO HSM88AS-TR	T	69/76.3
D201	1720000830	S.VCP KV1770STL	T	74.3/88.7
D202	1720000830	S.VCP KV1770STL	B	74.3/88.7
D221	1720000830	S.VCP KV1770STL	T	57.5/88.7
D222	1720000830	S.VCP KV1770STL	B	57.5/88.7
D251	1790000540	S.VCP MA338 (TX)	T	39.1/87.9
D252	1790000540	S.VCP MA338 (TX)	T	41.4/87.9
D253	1790000540	S.VCP MA338 (TX)	B	41.4/87.9
D254	1790000540	S.VCP MA338 (TX)	B	39.1/87.9

[KEY UNIT]

REF NO.	ORDER NO.	DESCRIPTION	M.	H/V LOCATION
C1	4030006880	S.CER C1608 JB 1H 472K-T	T	15.2/6.5
C2	4030006880	S.CER C1608 JB 1H 472K-T	T	15.2/3
J1	6510022620	S.CNR 10FMN-BMTTR-A-TBT	T	7.2/4
J2	6450001790	CNR HLJ7000-01-3010	T	7.1/31
EP1	6910012350	S.BEA MMZ1608Y 102BT	B	14.2/20.4
EP2	6910012350	S.BEA MMZ1608Y 102BT	B	14.1/4.2
EP3	0910052312	PCB B 5406B		

[MIC UNIT]

REF NO.	ORDER NO.	DESCRIPTION	M.	H/V LOCATION
L1	6200003260	S.COL NL 322522T-101J	B	4.7/14.4
L3	6200003260	S.COL NL 322522T-101J	B	3.1/10.6
L4	6200003260	S.COL NL 322522T-101J	B	5.2/2.5
L6	6200003950	S.COL HF50ACC 322513-T	B	16.8/17
C2	4030006880	S.CER C1608 JB 1H 472K-T	B	3.8/6.2
C3	4030006880	S.CER C1608 JB 1H 472K-T	B	2.5/6.2
C4	4030006880	S.CER C1608 JB 1H 472K-T	B	8.1/2.7
C5	4030006880	S.CER C1608 JB 1H 472K-T	B	17.5/6.7
C6	4030006880	S.CER C1608 JB 1H 472K-T	B	16.2/13.1
C7	4030007130	S.CER C1608 CH 1H 101J-T	B	9.8/15.6
J1	6510000190	CNR FM214-8SS (P)	T	10.5/9
J2	6510022620	S.CNR 10FMN-BMTTR-A-TBT	B	8.1/19
EP1	0910052324	PCB B 5407D		

M.=Mounted side (T: Mounted on the Top side, B: Mounted on the Bottom side)

S.=Surface mount

[PLL UNIT]

REF NO.	ORDER NO.	DESCRIPTION	M.	H/V LOCATION
D271	1790000540	S.VCP MA338 (TX)	T	22.3/87.9
D272	1790000540	S.VCP MA338 (TX)	T	24.6/87.9
D273	1790000540	S.VCP MA338 (TX)	B	24.5/87.9
D274	1790000540	S.VCP MA338 (TX)	B	22.3/87.9
D301	1790000620	S.DIO MA77 (TX)	T	23.6/63.9
D351	1790000620	S.DIO MA77 (TX)	T	9.8/72.6
D361	1750000580	S.DIO 1SV307 (TPH3)	B	5.5/80
D362	1750000580	S.DIO 1SV307 (TPH3)	B	5.5/78.4
D451	1720000590	S.VCP MA357 (TX)	T	73.1/33.2
D452	1790000490	S.DIO HSM88AS-TR	T	74.9/45.9
D453	1790000490	S.DIO HSM88AS-TR	T	75/42.7
D501	1720000830	S.VCP KV1770STL	T	30.3/21.2
D502	1720000830	S.VCP KV1770STL	B	30.3/21.2
D521	1720000830	S.VCP KV1770STL	T	13.5/21.2
D522	1720000830	S.VCP KV1770STL	B	13.5/21.2
D551	1790000540	S.VCP MA338 (TX)	T	48.7/22
D552	1790000540	S.VCP MA338 (TX)	T	46.4/22
D553	1790000540	S.VCP MA338 (TX)	B	46.5/22
D554	1790000540	S.VCP MA338 (TX)	B	48.7/22
D571	1790000540	S.VCP MA338 (TX)	T	65.5/22
D572	1790000540	S.VCP MA338 (TX)	T	63.2/22
D573	1790000540	S.VCP MA338 (TX)	B	63.3/22
D574	1790000540	S.VCP MA338 (TX)	B	65.5/22
D601	1790000620	S.DIO MA77 (TX)	T	19.9/47.4
D651	1790000620	S.DIO MA77 (TX)	T	8.2/36.9
D661	1750000580	S.DIO 1SV307 (TPH3)	B	6.3/29.6
D662	1750000580	S.DIO 1SV307 (TPH3)	B	4.4/29.6
D901	1720000590	S.VCP MA357 (TX)	T	110.3/54.3
D902	1750000070	S.DIO 1SS226 (TE85R)	B	103.8/52.7
FI101	2020001690	S.CER SFECY10M8TF00-R0	T	95.7/104.8
FI401	2020001690	S.CER SFECY10M8TF00-R0	T	92.9/28.8
X52	6050011390	XTL CR-338 (32.00000 MHz)	T	132.1/78.4
L1	6200003950	S.COL HF50ACC 322513-T	B	153.7/61.5
L2	6200003950	S.COL HF50ACC 322513-T	B	153.7/64.5
L31	6200003590	S.COL EXCCL3225U1	T	141.9/71.9
L51	6200008910	S.COL 1812CS-122XKBC	T	132.5/93.7
L52	6150004370	COL LS-472C (C-15045)	T	143.5/95.5
L55	6200001830	S.COL NL 322522T-100J	T	142.1/77.5
L81	6150004830	S.COL LS-509	T	133/103.4
L82	6150004830	S.COL LS-509	T	140.5/103.4
L101	6200001830	S.COL NL 322522T-100J	T	94.2/87.5
L121	6200001830	S.COL NL 322522T-100J	B	83.4/106.9
L122	6200001830	S.COL NL 322522T-100J	B	85.1/103.9
L123	6200001830	S.COL NL 322522T-100J	B	83.8/100.9
L124	6200001830	S.COL NL 322522T-100J	T	82.6/91.2
L125	6200001830	S.COL NL 322522T-100J	T	82.6/94.2
L126	6200001830	S.COL NL 322522T-100J	B	84.8/97.9
L128	6200001830	S.COL NL 322522T-100J	T	85.5/88.2
L152	6130002970	COL LB-343	T	72.2/68.6
L153	6200001830	S.COL NL 322522T-100J	T	63.3/65.7
L181	6200001830	S.COL NL 322522T-100J	T	50/74.9
L202	6190001410	COL E526GN-110501	T	69.7/97
L204	6200003260	S.COL NL 322522T-101J	B	74.1/92.4
L205	6200008910	S.COL 1812CS-122XKBC	T	63.9/91.5
L206	6200008910	S.COL 1812CS-122XKBC	T	67.8/86.8
L222	6190001410	COL E526GN-110501	T	52.9/97
L224	6200003260	S.COL NL 322522T-101J	B	57.3/92.4
L225	6200008910	S.COL 1812CS-122XKBC	T	46.9/91.5
L226	6200008910	S.COL 1812CS-122XKBC	T	51/86.8
L252	6190001420	COL E526GN-110502	T	36.1/97
L254	6200003260	S.COL NL 322522T-101J	B	39.6/92.4
L255	6200008910	S.COL 1812CS-122XKBC	T	29.9/91.5
L256	6200008910	S.COL 1812CS-122XKBC	T	34.4/86.8
L272	6190001440	COL E526GN-110504	T	19.3/97
L274	6200003260	S.COL NL 322522T-101J	B	22.8/92.4
L275	6200008910	S.COL 1812CS-122XKBC	T	13.4/91.5
L276	6200008910	S.COL 1812CS-122XKBC	T	16/86.8
L301	6200005550	S.COL ELJFC 100K-F	T	42.4/73.5
L303	6200004030	S.COL NL 322522T-047J	T	20.6/64.9
L304	6200002960	S.COL NL 322522T-4R7J-3	T	50.4/64
L320	6200004590	S.COL MLF1608D R18K-T	T	44.8/71
L321	6200003020	S.COL NL 322522T-R33J-3	T	31.8/62.8
L328	6200006990	S.COL ELJRE 56NG-F	T	40.2/67.6
L329	6200006990	S.COL ELJRE 56NG-F	T	44.8/65
L351	6200002410	S.COL NL 252018T-056J	T	7.8/66.4
L352	6200002430	S.COL NL 252018T-082J	T	10.7/66.4
L353	6200002430	S.COL NL 252018T-082J	T	11.9/71.8
L354	6200003420	S.COL NL 322522T-R15J-3	T	8.1/76.1
L355	6200000880	S.COL NL 322522T-4R7M	T	12.1/80.5
L357	6200003160	S.COL NL 322522T-270J	T	4.5/65.9
L382	6200003950	S.COL HF50ACC 322513-T	T	36/75.4
L401	6200001830	S.COL NL 322522T-100J	T	89.7/14.1
L421	6200001830	S.COL NL 322522T-100J	B	81.9/2.4
L422	6200001830	S.COL NL 322522T-100J	B	83/5.4
L423	6200001830	S.COL NL 322522T-100J	B	83.6/8.5
L424	6200001830	S.COL NL 322522T-100J	T	82.5/19.4
L425	6200001830	S.COL NL 322522T-100J	T	82.2/26

M.=Mounted side (T: Mounted on the Top side, B: Mounted on the Bottom side)

[PLL UNIT]

REF NO.	ORDER NO.	DESCRIPTION	M.	H/V LOCATION
L426	6200001830	S.COL NL 322522T-100J	B	85.8/11.8
L428	6200001830	S.COL NL 322522T-100J	T	82.5/29.1
L452	6130002970	COL LB-343	T	75.9/36.5
L453	6200001830	S.COL NL 322522T-100J	T	64.4/39.5
L481	6200001830	S.COL NL 322522T-100J	T	51.7/35.2
L491	6200003040	S.COL NL 322522T-R68J-3	B	116.2/6.8
L492	6200003050	S.COL NL 322522T-R82J-3	B	116.5/12.8
L502	6190001410	COL E526GN-110501	T	34.9/13
L504	6200003260	S.COL NL 322522T-101J	B	29.7/17.5
L505	6200008910	S.COL 1812CS-122XKBC	T	40.7/18.4
L506	6200008910	S.COL 1812CS-122XKBC	T	36.6/23.1
L522	6190001410	COL E526GN-110501	T	18.1/13
L524	6200003260	S.COL NL 322522T-101J	B	13.4/17.6
L525	6200008910	S.COL 1812CS-122XKBC	T	24.1/18.5
L526	6200008910	S.COL 1812CS-122XKBC	T	19.7/23.1
L552	6190001420	COL E526GN-110502	T	51.7/13
L554	6200003260	S.COL NL 322522T-101J	B	47/17.6
L555	6200008910	S.COL 1812CS-122XKBC	T	57.9/18.4
L556	6200008910	S.COL 1812CS-122XKBC	T	53.3/23.1
L572	6190001440	COL E526GN-110504	T	68.5/13
L574	6200003260	S.COL NL 322522T-101J	B	63.8/17.6
L575	6200008910	S.COL 1812CS-122XKBC	T	73.9/18.4
L576	6200008910	S.COL 1812CS-122XKBC	T	72/23.1
L601	6200005550	S.COL ELJFC 100K-F	T	39.8/32.6
L603	6200004030	S.COL NL 322522T-047J	T	19.6/45
L604	6200000880	S.COL NL 322522T-4R7M	B	48.8/32.6
L620	6200004590	S.COL MLF1608D R18K-T	T	44.6/38.2
L621	6200003020	S.COL NL 322522T-R33J-3	T	32.1/48
L627	6200006990	S.COL ELJRE 56NG-F	T	41.8/43.4
L628	6200006990	S.COL ELJRE 56NG-F	T	44.8/45.5
L651	6200002410	S.COL NL 252018T-056J	T	11.8/43.6
L652	6200002430	S.COL NL 252018T-082J	T	11.7/40.8
L653	6200002430	S.COL NL 252018T-082J	T	10.7/36.6
L654	6200003420	S.COL NL 322522T-R15J-3	T	4.3/37.3
L655	6200002960	S.COL NL 322522T-4R7J-3	T	11.2/30.3
L657	6200003160	S.COL NL 322522T-270J	T	4.5/43.3
L682	6200003950	S.COL HF50ACC 322513-T	T	25.2/33.9
L701	6200001830	S.COL NL 322522T-100J	T	129.8/35.1
L702	6200005490	S.COL NL 322522T-331J	T	130.6/44.4
L703	6200008640	S.COL NL 322522T-391J	T	130/47.9
L704	6200008640	S.COL NL 322522T-391J	T	134.5/55.3
L801	6200001830	S.COL NL 322522T-100J	B	131.2/17.5
L802	6200001830	S.COL NL 322522T-100J	B	144.3/16.7
L803	6200003130	S.COL NL 322522T-120J	B	141.1/21.8
L804	6200003170	S.COL NL 322522T-330J	T	151.6/10.8
L806	6200002980	S.COL NL 322522T-R56J-3	T	150.7/21
L901	6200008940	S.COL LQH32MM331K21L	T	92.9/49.6
L902	6200004950	S.COL NL 252018T-1R8J	T	92.8/44.4
L903	6200003260	S.COL NL 322522T-101J	T	107.9/54.7
L904	6190000950	COL C-13975-6.5T	T	115.9/55.8
L905	6200003660	S.COL NL 252018T-R68J	T	114.8/49.4
L906	6200003260	S.COL NL 322522T-101J	B	111.4/49.4
L907	6200002630	S.COL NL 252018T-R10J	T	120.4/42.8
L908	6200002180	S.COL NL 252018T-R12J	T	119.5/39.9
L909	6200003260	S.COL NL 322522T-101J	T	119/55.4
L910	6200004960	S.COL NL 252018T-R33J	T	117.4/45.2
R1	7030003320	S.RES ERJ3GEYJ 101 V (100 Ω)	T	148.8/62.3
R2	7030003440	S.RES ERJ3GEYJ 102 V (1 kΩ)	T	146.8/64.5
R3	7030003280	S.RES ERJ3GEYJ 470 V (47 Ω)	T	145.5/59.6
R4	7030003280	S.RES ERJ3GEYJ 470 V (47 Ω)	B	148.7/71.5
R5	7030003440	S.RES ERJ3GEYJ 102 V (1 kΩ)	T	148.8/61
R8	7030003440	S.RES ERJ3GEYJ 102 V (1 kΩ)	T	147.1/70.5
R9	7030003440	S.RES ERJ3GEYJ 102 V (1 kΩ)	T	134.4/60
R10	7030003640	S.RES ERJ3GEYJ 473 V (47 kΩ)	T	142.2/61.4
R11	7030003640	S.RES ERJ3GEYJ 473 V (47 kΩ)	B	148.7/73.2
R12	7030003640	S.RES ERJ3GEYJ 473 V (47 kΩ)	T	146.1/61
R13	7030003640	S.RES ERJ3GEYJ 473 V (47 kΩ)	B	149.1/68.7
R14	7030003640	S.RES ERJ3GEYJ 473 V (47 kΩ)	T	133.1/60
R15	7030003560	S.RES ERJ3GEYJ 103 V (10 kΩ)	T	140/62.1
R32	7310003820	TRI EVN-D2AA03 B14	T	1.8/73.5
R33	7310002720	S.TRI RV-148 (RH03A3AS3X0DA) 472	T	11.9/55.1
R36	7030003640	S.RES ERJ3GEYJ 473 V (47 kΩ)	T	8.9/52.7
R40	7030003550	S.RES ERJ3GEYJ 822 V (8.2 kΩ)	T	106.2/66.8
R41	7030003550	S.RES ERJ3GEYJ 822 V (8.2 kΩ)	T	107.5/67.6
R42	7030003550	S.RES ERJ3GEYJ 822 V (8.2 kΩ)	T	120.1/74.4
R43	7030003550	S.RES ERJ3GEYJ 822 V (8.2 kΩ)	T	118.9/72.4
R44	7030003550	S.RES ERJ3GEYJ 822 V (8.2 kΩ)	T	118.9/71.1
R45	7030003550	S.RES ERJ3GEYJ 822 V (8.2 kΩ)	T	106.2/69.8
R46	7030003550	S.RES ERJ3GEYJ 822 V (8.2 kΩ)	T	109/71.4
R47	7030003440	S.RES ERJ3GEYJ 102 V (1 kΩ)	T	117.8/63.2
R48	7030003440	S.RES ERJ3GEYJ 102 V (1 kΩ)	T	118.7/68.1
R51	7030003640	S.RES ERJ3GEYJ 473 V (47 kΩ)	B	135.5/91
R52	7030003580	S.RES ERJ3GEYJ 153 V (15 kΩ)	T	141/83
R53	7030003520	S.RES ERJ3GEYJ 472 V (4.7 kΩ)	T	142.9/83.6
R54	7030003400	S.RES ERJ3GEYJ 471 V (470 Ω)	T	141/88.4
R55	7030003280	S.RES ERJ3GEYJ 470 V (47 Ω)	B	142.9/90.9
R57	7030003440	S.RES ERJ3GEYJ 102 V (1 kΩ)	T	3.8/69.4
R58	7030003610	S.RES ERJ3GEYJ 273 V (27 kΩ)	T	132.9/99.1
R60	7030003380	S.RES ERJ3GEYJ 331 V (330 Ω)	T	128.4/100.4
R61	7030003360	S.RES ERJ3GEYJ 221 V (220 Ω)	T	130.5/96.6
R62	7030003260	S.RES ERJ3GEYJ 330 V (33 Ω)	T	127.3/96.5

S.=Surface mount

[PLL UNIT]

REF NO.	ORDER NO.	DESCRIPTION	M.	H/V LOCATION
R63	7030003420	S.RES ERJ3GEYJ 681 V (680 Ω)	T	127.3/97.8
R71	7030003640	S.RES ERJ3GEYJ 473 V (47 kΩ)	T	128.2/104.8
R72	7030003380	S.RES ERJ3GEYJ 331 V (330 Ω)	T	126.1/105.6
R81	7030003600	S.RES ERJ3GEYJ 223 V (22 kΩ)	B	130.4/103
R82	7030003560	S.RES ERJ3GEYJ 103 V (10 kΩ)	B	133/105.9
R83	7030003370	S.RES ERJ3GEYJ 271 V (270 Ω)	B	137.4/105.3
R84	7030003320	S.RES ERJ3GEYJ 101 V (100 Ω)	T	127.9/102.2
R85	7030003350	S.RES ERJ3GEYJ 181 V (180 Ω)	B	145.6/100.8
R86	7030003350	S.RES ERJ3GEYJ 181 V (180 Ω)	B	148.2/101.8
R87	7030003220	S.RES ERJ3GEYJ 150 V (15 Ω)	B	141.5/103.1
R89	7030003260	S.RES ERJ3GEYJ 330 V (33 Ω)	B	128.6/103
R125	7030003400	S.RES ERJ3GEYJ 471 V (470 Ω)	T	100.1/103.2
R127	7030003800	S.RES ERJ3GEYJ 105 V (1 MΩ)	T	94/94.4
R130	7030003200	S.RES ERJ3GEYJ 100 V (10 Ω)	T	91.6/87.6
R131	7030003320	S.RES ERJ3GEYJ 101 V (100 Ω)	T	90.5/84.6
R132	7030003640	S.RES ERJ3GEYJ 473 V (47 kΩ)	T	91.7/81.9
R133	7030003360	S.RES ERJ3GEYJ 221 V (220 Ω)	T	91.8/84.6
R134	7030003240	S.RES ERJ3GEYJ 220 V (22 Ω)	T	95/85.4
R135	7030003330	S.RES ERJ3GEYJ 121 V (120 Ω)	T	102.4/78.5
R136	7030003220	S.RES ERJ3GEYJ 150 V (15 Ω)	T	98.6/78.9
R137	7030003840	S.RES ERJ3GEYJ 225 V (2.2 MΩ)	T	100.5/79.5
R139	7030003640	S.RES ERJ3GEYJ 473 V (47 kΩ)	T	119.9/87
R140	7030003370	S.RES ERJ3GEYJ 271 V (270 Ω)	T	118.6/86.1
R141	7030003320	S.RES ERJ3GEYJ 101 V (100 Ω)	T	90.5/81.9
R142	7030003440	S.RES ERJ3GEYJ 102 V (1 kΩ)	B	100.6/73
R143	7030003440	S.RES ERJ3GEYJ 102 V (1 kΩ)	T	116.7/97.3
R144	7030003440	S.RES ERJ3GEYJ 102 V (1 kΩ)	T	118/97.7
R145	7030003440	S.RES ERJ3GEYJ 102 V (1 kΩ)	T	118.7/92.5
R146	7030003440	S.RES ERJ3GEYJ 102 V (1 kΩ)	T	118.7/91.2
R147	7030003440	S.RES ERJ3GEYJ 102 V (1 kΩ)	B	112.7/80.8
R150	7030003560	S.RES ERJ3GEYJ 103 V (10 kΩ)	T	72.8/76.5
R151	7030003680	S.RES ERJ3GEYJ 104 V (100 kΩ)	T	65.9/68
R152	7030003680	S.RES ERJ3GEYJ 104 V (100 kΩ)	T	65.3/75.3
R153	7030003340	S.RES ERJ3GEYJ 151 V (150 Ω)	T	68/66.8
R154	7030003320	S.RES ERJ3GEYJ 101 V (100 Ω)	T	61.2/71.4
R155	7030003350	S.RES ERJ3GEYJ 181 V (180 Ω)	T	62.6/72.7
R156	7030003640	S.RES ERJ3GEYJ 473 V (47 kΩ)	T	66/64.4
R157	7030003360	S.RES ERJ3GEYJ 221 V (220 Ω)	T	70.7/65.5
R158	7030003320	S.RES ERJ3GEYJ 101 V (100 Ω)	T	72.7/64.8
R159	7030003220	S.RES ERJ3GEYJ 150 V (15 Ω)	T	74/64.8
R160	7030003220	S.RES ERJ3GEYJ 150 V (15 Ω)	T	76.6/64.8
R161	7030003310	S.RES ERJ3GEYJ 820 V (82 Ω)	T	75.3/64.8
R181	7030003440	S.RES ERJ3GEYJ 102 V (1 kΩ)	T	53.4/74.1
R182	7030003530	S.RES ERJ3GEYJ 562 V (5.6 kΩ)	T	53.4/76.7
R191	7030003320	S.RES ERJ3GEYJ 101 V (100 Ω)	T	98.2/69.4
R192	7030003480	S.RES ERJ3GEYJ 222 V (2.2 kΩ)	T	96.2/68.9
R204	7030003560	S.RES ERJ3GEYJ 103 V (10 kΩ)	T	72.4/99.5
R224	7030003560	S.RES ERJ3GEYJ 103 V (10 kΩ)	T	55.5/99.5
R254	7030003560	S.RES ERJ3GEYJ 103 V (10 kΩ)	T	38.8/99.5
R274	7030003560	S.RES ERJ3GEYJ 103 V (10 kΩ)	T	22/99.6
R275	7030003280	S.RES ERJ3GEYJ 470 V (47 Ω)	B	42.6/79
R301	7030003470	S.RES ERJ3GEYJ 182 V (1.8 kΩ)	T	42.1/78.9
R302	7030003480	S.RES ERJ3GEYJ 222 V (2.2 kΩ)	T	44.8/78.8
R303	7030003440	S.RES ERJ3GEYJ 102 V (1 kΩ)	T	44.8/77.5
R304	7030003260	S.RES ERJ3GEYJ 330 V (33 Ω)	T	50.4/66.8
R309	7030003410	S.RES ERJ3GEYJ 561 V (560 Ω)	T	18.6/69
R320	7030003400	S.RES ERJ3GEYJ 471 V (470 Ω)	T	42.1/69.7
R321	7030003200	S.RES ERJ3GEYJ 100 V (10 Ω)	T	42.1/68.4
R322	7030003400	S.RES ERJ3GEYJ 471 V (470 Ω)	T	44.2/68.9
R323	7030003200	S.RES ERJ3GEYJ 100 V (10 Ω)	T	29/61.3
R350	7030003470	S.RES ERJ3GEYJ 182 V (1.8 kΩ)	T	24/61.1
R351	7030003490	S.RES ERJ3GEYJ 272 V (2.7 kΩ)	T	23.9/62.4
R352	7030003370	S.RES ERJ3GEYJ 271 V (270 Ω)	B	8.5/80.5
R353	7030003220	S.RES ERJ3GEYJ 150 V (15 Ω)	B	8.9/83.1
R354	7030003370	S.RES ERJ3GEYJ 271 V (270 Ω)	B	8.9/84.9
R355	7030003320	S.RES ERJ3GEYJ 101 V (100 Ω)	T	6.1/61.1
R356	7030003640	S.RES ERJ3GEYJ 473 V (47 kΩ)	T	7.6/71.4
R361	7030003520	S.RES ERJ3GEYJ 472 V (4.7 kΩ)	T	9.9/78.7
R362	7030003320	S.RES ERJ3GEYJ 101 V (100 Ω)	B	14.8/60.7
R363	7030003520	S.RES ERJ3GEYJ 472 V (4.7 kΩ)	B	2.7/80.7
R380	7030003560	S.RES ERJ3GEYJ 103 V (10 kΩ)	B	38.7/69.4
R381	7030003320	S.RES ERJ3GEYJ 101 V (100 Ω)	B	40.7/73.9
R385	7030003440	S.RES ERJ3GEYJ 102 V (1 kΩ)	T	35.2/68.7
R386	7030003440	S.RES ERJ3GEYJ 102 V (1 kΩ)	T	35.2/66.9
R387	7030003440	S.RES ERJ3GEYJ 102 V (1 kΩ)	T	35.2/69.8
R425	7030003400	S.RES ERJ3GEYJ 471 V (470 Ω)	T	97.3/27.2
R427	7030003800	S.RES ERJ3GEYJ 105 V (1 MΩ)	T	92.9/9.2
R430	7030003200	S.RES ERJ3GEYJ 100 V (10 Ω)	T	88.1/11.3
R431	7030003320	S.RES ERJ3GEYJ 101 V (100 Ω)	T	90/23.7
R432	7030003640	S.RES ERJ3GEYJ 473 V (47 kΩ)	T	95/24.2
R433	7030003360	S.RES ERJ3GEYJ 221 V (220 Ω)	T	92.1/16.4
R434	7030003240	S.RES ERJ3GEYJ 220 V (22 Ω)	T	89.4/16.4
R435	7030003330	S.RES ERJ3GEYJ 121 V (120 Ω)	T	97.8/3.1
R436	7030003220	S.RES ERJ3GEYJ 150 V (15 Ω)	T	96.5/3.1
R437	7030003840	S.RES ERJ3GEYJ 225 V (2.2 MΩ)	T	95.2/3.5
R439	7030003640	S.RES ERJ3GEYJ 473 V (47 kΩ)	T	114.6/13.6
R440	7030003370	S.RES ERJ3GEYJ 271 V (270 Ω)	T	115.8/7.1
R441	7030003320	S.RES ERJ3GEYJ 101 V (100 Ω)	T	90.4/21.6
R442	7030003440	S.RES ERJ3GEYJ 102 V (1 kΩ)	T	99.1/3.6
R443	7030003440	S.RES ERJ3GEYJ 102 V (1 kΩ)	B	114.5/21.1
R444	7030003440	S.RES ERJ3GEYJ 102 V (1 kΩ)	B	116.3/21.1
R445	7030003440	S.RES ERJ3GEYJ 102 V (1 kΩ)	T	115.1/16.2
R446	7030003440	S.RES ERJ3GEYJ 102 V (1 kΩ)	T	114.6/14.9

M.=Mounted side (T: Mounted on the Top side, B: Mounted on the Bottom side)

[PLL UNIT]

REF NO.	ORDER NO.	DESCRIPTION	M.	H/V LOCATION
R447	7030003440	S.RES ERJ3GEYJ 102 V (1 kΩ)	B	100.4/14.9
R450	7030003560	S.RES ERJ3GEYJ 103 V (10 kΩ)	T	75.3/32.9
R451	7030003680	S.RES ERJ3GEYJ 104 V (100 kΩ)	T	71.9/45.9
R452	7030003680	S.RES ERJ3GEYJ 104 V (100 kΩ)	T	63.9/42.8
R453	7030003340	S.RES ERJ3GEYJ 151 V (150 Ω)	T	65.6/37.3
R454	7030003320	S.RES ERJ3GEYJ 101 V (100 Ω)	T	61.3/43
R455	7030003350	S.RES ERJ3GEYJ 181 V (180 Ω)	T	69.2/45.9
R456	7030003640	S.RES ERJ3GEYJ 473 V (47 kΩ)	T	68/32.8
R457	7030003360	S.RES ERJ3GEYJ 221 V (220 Ω)	T	64/33.6
R458	7030003320	S.RES ERJ3GEYJ 101 V (100 Ω)	T	61.8/39.5
R459	7030003220	S.RES ERJ3GEYJ 150 V (15 Ω)	T	66.7/32.8
R461	7030003310	S.RES ERJ3GEYJ 820 V (82 Ω)	T	66.8/30.9
R481	7030003440	S.RES ERJ3GEYJ 102 V (1 kΩ)	T	52.2/32.4
R482	7030003530	S.RES ERJ3GEYJ 562 V (5.6 kΩ)	T	52.2/29.6
R492	7030003350	S.RES ERJ3GEYJ 181 V (180 Ω)	B	112.4/9.9
R504	7030003560	S.RES ERJ3GEYJ 103 V (10 kΩ)	T	32.2/10.5
R524	7030003560	S.RES ERJ3GEYJ 103 V (10 kΩ)	T	15.3/10.4
R554	7030003560	S.RES ERJ3GEYJ 103 V (10 kΩ)	T	48.9/10.4
R574	7030003560	S.RES ERJ3GEYJ 103 V (10 kΩ)	T	65.7/10.4
R575	7030003280	S.RES ERJ3GEYJ 470 V (47 Ω)	B	40.9/30.9
R601	7030003470	S.RES ERJ3GEYJ 182 V (1.8 kΩ)	T	38.8/34.6
R602	7030003480	S.RES ERJ3GEYJ 222 V (2.2 kΩ)	T	38.8/35.9
R603	7030003440	S.RES ERJ3GEYJ 102 V (1 kΩ)	T	44.6/36.9
R604	7030003260	S.RES ERJ3GEYJ 330 V (33 Ω)	B	45.2/32.6
R609	7030003410	S.RES ERJ3GEYJ 561 V (560 Ω)	T	20.8/39.8
R620	7030003400	S.RES ERJ3GEYJ 471 V (470 Ω)	T	44.6/39.5
R621	7030003200	S.RES ERJ3GEYJ 100 V (10 Ω)	T	41.8/40.8
R622	7030003400	S.RES ERJ3GEYJ 471 V (470 Ω)	T	44.6/40.8
R623	7030003200	S.RES ERJ3GEYJ 100 V (10 Ω)	T	29.9/48
R650	7030003470	S.RES ERJ3GEYJ 182 V (1.8 kΩ)	T	24.7/48.3
R651	7030003490	S.RES ERJ3GEYJ 272 V (2.7 kΩ)	T	26/48.7
R652	7030003370	S.RES ERJ3GEYJ 271 V (270 Ω)	B	1.7/30.3
R653	7030003220	S.RES ERJ3GEYJ 150 V (15 Ω)	B	8.9/27.8
R654	7030003370	S.RES ERJ3GEYJ 271 V (270 Ω)	B	8.9/26
R655	7030003320	S.RES ERJ3GEYJ 101 V (100 Ω)	T	6.4/48.1
R656	7030003640	S.RES ERJ3GEYJ 473 V (47 kΩ)	T	7.9/39.1
R660	7030003220	S.RES ERJ3GEYJ 150 V (15 Ω)	T	64.2/31.7
R661	7030003520	S.RES ERJ3GEYJ 472 V (4.7 kΩ)	T	9/30.5
R662	7030003320	S.RES ERJ3GEYJ 101 V (100 Ω)	T	1.7/32.9
R663	7030003520	S.RES ERJ3GEYJ 472 V (4.7 kΩ)	B	5.7/32.5
R680	7030003560	S.RES ERJ3GEYJ 103 V (10 kΩ)	B	34.8/41.8
R681	7030003320	S.RES ERJ3GEYJ 101 V (100 Ω)	B	37.4/41
R685	7030003440	S.RES ERJ3GEYJ 102 V (1 kΩ)	T	25.2/40.8
R686	7030003440	S.RES ERJ3GEYJ 102 V (1 kΩ)	T	25.2/42.1
R687	7030003440	S.RES ERJ3GEYJ 102 V (1 kΩ)	T	25.2/39.5
R688	7030003670	S.RES ERJ3GEYJ 823 V (82 kΩ)	B	51.4/51
R689	7030003590	S.RES ERJ3GEYJ 183 V (18 kΩ)	B	53.3/50.2
R721	7030003640	S.RES ERJ3GEYJ 473 V (47 kΩ)	B	144.2/36.7
R722	7030003370	S.RES ERJ3GEYJ 271 V (270 Ω)	B	144/32.2
R724	7030003480	S.RES ERJ3GEYJ 222 V (2.2 kΩ)	T	140.8/52.4
R727	7030003440	S.RES ERJ3GEYJ 102 V (1 kΩ)	T	132.3/27.9
R728	7030003440	S.RES ERJ3GEYJ 102 V (1 kΩ)	T	132.3/26.6
R729	7030003440	S.RES ERJ3GEYJ 102 V (1 kΩ)	T	132.3/29.2
R730	7030003440	S.RES ERJ3GEYJ 102 V (1 kΩ)	T	129.6/37.7
R821	7030003630	S.RES ERJ3GEYJ 393 V (39 kΩ)	T	123.8/7.2
R822	7030003350	S.RES ERJ3GEYJ 181 V (180 Ω)	T	127/4.3
R823	7030003470	S.RES ERJ3GEYJ 182 V (1.8 kΩ)	T	153.4/14.3
R824	7030003480	S.RES ERJ3GEYJ 222 V (2.2 kΩ)	T	153.4/16.9
R825	7030003360	S.RES ERJ3GEYJ 221 V (220 Ω)	T	153.4/19.5
R826	7030003320	S.RES ERJ3GEYJ 101 V (100 Ω)	T	149/16.1
R827	7030003440	S.RES ERJ3GEYJ 102 V (1 kΩ)	B	122.3/22.4
R828	7030003440	S.RES ERJ3GEYJ 102 V (1 kΩ)	B	122.3/20.6
R829	7030003440	S.RES ERJ3GEYJ 102 V (1 kΩ)	T	125/19.3
R830	7030003440	S.RES ERJ3GEYJ 102 V (1 kΩ)	T	128.1/20.7
R901	7030003440	S.RES ERJ3GEYJ 102 V (1 kΩ)	B	105.6/38.2
R902	7030003440	S.RES ERJ3GEYJ 102 V (1 kΩ)	B	103.8/38.2
R903	7030003440	S.RES ERJ3GEYJ 102 V (1 kΩ)	T	103.9/38.9
R904	7030003560	S.RES ERJ3GEYJ 103 V (10 kΩ)	B	97.1/43.9
R906	7030003280	S.RES ERJ3GEYJ 470 V (47 Ω)	T	94.9/40.6
R907	7030003650	S.RES ERJ3GEYJ 563 V (56 kΩ)	T	105.4/51.2
R908	7030003840	S.RES ERJ3GEYJ 225 V (2.2 MΩ)	T	104/54.8
R909	7030003460	S.RES ERJ3GEYJ 152 V (1.5 kΩ)	T	101.3/53.5
R910	7030003520	S.RES ERJ3GEYJ 472 V (4.7 kΩ)	T	96.7/56
R911	7030003440	S.RES ERJ3GEYJ 102 V (1 kΩ)	T	101.3/56.1
R912	7030003440	S.RES ERJ3GEYJ 102 V (1 kΩ)	T	107.3/51.9
R913	7030003680	S.RES ERJ3GEYJ 104 V (100 kΩ)	T	110.3/49.4
R914	7030003680	S.RES ERJ3GEYJ 104 V (100 kΩ)	T	106.9/47.9
R915	7030003320	S.RES ERJ3GEYJ 101 V (100 Ω)	T	111.2/47.3
R916	7030003340	S.RES ERJ3GEYJ 151 V (150 Ω)	T	113.1/47.5
R917	7030003320	S.RES ERJ3GEYJ 101 V (100 Ω)	T	109.5/44.5
R918	7030003680	S.RES ERJ3GEYJ 104 V (100 kΩ)	T	109.9/41.9
R919	7030003440	S.RES ERJ3GEYJ 102 V (1 kΩ)	T	112.3/39.5
R920	7030003280	S.RES ERJ3GEYJ 470 V (47 Ω)	T	

[PLL UNIT]

REF NO.	ORDER NO.	DESCRIPTION	M.	H/V LOCATION
C4	4550006080	S.TAN TEESVB2 1C 106M8L	B	141.3/62.1
C5	4030011600	S.CER C1608 JB 1E 104K-T	T	109.1/66.5
C31	4030006880	S.CER C1608 JB 1H 472K-T	T	7.7/51.4
C32	4030006880	S.CER C1608 JB 1H 472K-T	B	132.1/70.2
C33	4550002810	S.TAN TEESVD2 1E 106M12L	B	132.1/74.1
C34	4030006880	S.CER C1608 JB 1H 472K-T	B	4/69.5
C35	4030006880	S.CER C1608 JB 1H 472K-T	B	4.2/73.5
C40	4030007050	S.CER C1608 CH 1H 220J-T	T	143.5/61.4
C41	4030007050	S.CER C1608 CH 1H 220J-T	B	145.7/73.5
C50	4030006880	S.CER C1608 JB 1H 472K-T	B	135.5/89.2
C51	4030007020	S.CER C1608 CH 1H 120J-T	B	142.9/87.3
C53	4030007120	S.CER C1608 CH 1H 820J-T	T	141/85.7
C54	4030006880	S.CER C1608 JB 1H 472K-T	T	142.9/87.7
C56	4030006880	S.CER C1608 JB 1H 472K-T	T	142.9/81
C58	4030018700	S.CER GRM1882P1H121JZ01D	T	142.9/90.3
C64	4030006880	S.CER C1608 JB 1H 472K-T	T	135/98.3
C65	4030011600	S.CER C1608 JB 1E 104K-T	T	132.4/97.2
C71	4030006880	S.CER C1608 JB 1H 472K-T	T	126.5/99.7
C81	4030006880	S.CER C1608 JB 1H 472K-T	B	129.6/105.9
C82	4030007170	S.CER C1608 CH 1H 221J-T	B	135.6/105.3
C83	4030007050	S.CER C1608 CH 1H 220J-T	T	135.1/107.7
C84	4030006880	S.CER C1608 JB 1H 472K-T	T	132.4/107.7
C85	4030009510	S.CER C1608 CH 1H 010B-T	T	137.8/107.7
C86	4030007050	S.CER C1608 CH 1H 220J-T	T	140.6/107.5
C87	4030006880	S.CER C1608 JB 1H 472K-T	B	141.5/100.8
C88	4030006880	S.CER C1608 JB 1H 472K-T	T	127.9/103.5
C101	4550006080	S.TAN TEESVB2 1C 106M8L	B	102.7/87.5
C102	4030011600	S.CER C1608 JB 1E 104K-T	T	114.8/98.6
C103	4030011600	S.CER C1608 JB 1E 104K-T	T	102.4/99.5
C104	4030011600	S.CER C1608 JB 1E 104K-T	T	99.7/100
C105	4030011600	S.CER C1608 JB 1E 104K-T	T	97.2/95.6
C106	4030011600	S.CER C1608 JB 1E 104K-T	T	97.1/92.6
C107	4030011600	S.CER C1608 JB 1E 104K-T	T	95.9/90.7
C108	4030011600	S.CER C1608 JB 1E 104K-T	T	97.1/87.4
C109	4030011600	S.CER C1608 JB 1E 104K-T	T	97.5/82.3
C110	4030011600	S.CER C1608 JB 1E 104K-T	T	107.2/79.2
C111	4030011600	S.CER C1608 JB 1E 104K-T	T	105.9/79.2
C112	4030011600	S.CER C1608 JB 1E 104K-T	T	104/79.8
C113	4030011600	S.CER C1608 JB 1E 104K-T	T	116.7/84.4
C114	4030011600	S.CER C1608 JB 1E 104K-T	T	116.7/89.3
C115	4030011600	S.CER C1608 JB 1E 104K-T	T	114.8/97.3
C116	4030011600	S.CER C1608 JB 1E 104K-T	T	100.1/106.1
C117	4030011600	S.CER C1608 JB 1E 104K-T	T	91.3/103.6
C118	4030011600	S.CER C1608 JB 1E 104K-T	T	92.3/89.7
C119	4030006880	S.CER C1608 JB 1H 472K-T	T	91.8/81.9
C120	4030011600	S.CER C1608 JB 1E 104K-T	T	93.1/84.6
C121	4550006250	S.TAN TEESVA 1A 106M8L	T	97.4/80.6
C122	4030006880	S.CER C1608 JB 1H 472K-T	T	119.3/95
C123	4030006880	S.CER C1608 JB 1H 472K-T	T	114.6/79
C124	4030006880	S.CER C1608 JB 1H 472K-T	T	113.3/79
C125	4030006880	S.CER C1608 JB 1H 472K-T	T	112/79
C126	4030006880	S.CER C1608 JB 1H 472K-T	B	108.5/84.9
C127	4030006880	S.CER C1608 JB 1H 472K-T	B	108.5/83.6
C128	4030006880	S.CER C1608 JB 1H 472K-T	B	108.5/86.2
C129	4030006880	S.CER C1608 JB 1H 472K-T	B	108.6/79
C130	4030006880	S.CER C1608 JB 1H 472K-T	T	110.6/78.6
C131	4030012600	S.CER C2012 JB 1A 105M-T	B	101.1/76.5
C132	4030006880	S.CER C1608 JB 1H 472K-T	T	84.9/107.7
C133	4030006880	S.CER C1608 JB 1H 472K-T	T	84.9/104.5
C134	4030006880	S.CER C1608 JB 1H 472K-T	T	86.2/101.4
C137	4030006880	S.CER C1608 JB 1H 472K-T	T	80.8/108.3
C138	4030006880	S.CER C1608 JB 1H 472K-T	T	80.8/104.8
C139	4030006880	S.CER C1608 JB 1H 472K-T	T	81.1/101
C146	4030006880	S.CER C1608 JB 1H 472K-T	T	86.1/98.1
C147	4030006880	S.CER C1608 JB 1H 472K-T	T	81.1/99.7
C150	4030011600	S.CER C1608 JB 1E 104K-T	T	82.9/88.4
C151	4030006880	S.CER C1608 JB 1H 472K-T	T	72.8/75.2
C152	4030007070	S.CER C1608 CH 1H 330J-T	T	74.7/74.7
C153	4030009910	S.CER C1608 CH 1H 040B-T	T	72.8/73.9
C154	4610001850	S.TRI TTB4R200AB10R00	T	
C155	4030016550	S.CER CM105 CH 151G 50AT	T	65.9/70.7
C156	4030016550	S.CER CM105 CH 151G 50AT	T	64/71.4
C157	4030016550	S.CER CM105 CH 151G 50AT	T	61.5/70
C158	4550006080	S.TAN TEESVB2 1C 106M8L	T	62.3/76.1
C159	4030006880	S.CER C1608 JB 1H 472K-T	T	65.3/74
C160	4030006880	S.CER C1608 JB 1H 472K-T	T	65.3/72.7
C161	4030009920	S.CER C1608 CH 1H 050B-T	T	62.6/63.5
C162	4030011600	S.CER C1608 JB 1E 104K-T	T	70.7/66.8
C163	4030006880	S.CER C1608 JB 1H 472K-T	T	70.7/64.2
C172	4030006990	S.CER C1608 CH 1H 080D-T	B	106.7/97.9
C173	4030007030	S.CER C1608 CH 1H 150J-T	B	104.9/97.9
C174	4030007060	S.CER C1608 CH 1H 270J-T	B	103.1/98.8
C181	4030006880	S.CER C1608 JB 1H 472K-T	T	53.4/75.4
C182	4550006080	S.TAN TEESVB2 1C 106M8L	T	56.3/76.4
C183	4030006880	S.CER C1608 JB 1H 472K-T	T	53.4/78
C191	4030011600	S.CER C1608 JB 1E 104K-T	T	115.9/79
C192	4030011600	S.CER C1608 JB 1E 104K-T	T	98.8/72.2
C201	4030006880	S.CER C1608 JB 1H 472K-T	T	64.4/86.3
C202	4030009990	S.CER C1608 CH 1H 200J-T	T	68.8/89.6
C203	4030006880	S.CER C1608 JB 1H 472K-T	T	64.2/94.4
C204	4030011340	S.CER C1608 CH 1H 471J-T	T	63.2/88.1
C205	4030006880	S.CER C1608 JB 1H 472K-T	T	73.6/105.3
C206	4030009510	S.CER C1608 CH 1H 010B-T	B	68.9/94.1

M.=Mounted side (T: Mounted on the Top side, B: Mounted on the Bottom side)

[PLL UNIT]

REF NO.	ORDER NO.	DESCRIPTION	M.	H/V LOCATION
C207	4030006880	S.CER C1608 JB 1H 472K-T	T	74.3/100.2
C208	4610001860	S.TRI TTB4Z060AB10R00	T	70.8/92.6
C209	4030009350	S.CER C1608 CH 1H 3R5B-T	T	74.5/94.1
C222	4030007100	S.CER C1608 CH 1H 560J-T	T	51.6/89.7
C223	4030006880	S.CER C1608 JB 1H 472K-T	T	47.4/94.4
C224	4030011340	S.CER C1608 CH 1H 471J-T	T	46.3/88.1
C225	4030006880	S.CER C1608 JB 1H 472K-T	T	56.8/105.3
C226	4030006920	S.CER C1608 CH 1H 010C-T	B	52.4/94.1
C227	4030006880	S.CER C1608 JB 1H 472K-T	T	57.5/100.2
C228	4610001830	S.TRI TTB4S100AB10R00	T	53.9/92.6
C229	4030009920	S.CER C1608 CH 1H 050B-T	T	57.7/94.1
C252	4030007150	S.CER C1608 CH 1H 151J-T	T	34.3/89.7
C253	4030006880	S.CER C1608 JB 1H 472K-T	T	30.6/94.4
C254	4030011340	S.CER C1608 CH 1H 471J-T	T	29.6/88.1
C255	4030006880	S.CER C1608 JB 1H 472K-T	T	40/105.3
C256	4030009510	S.CER C1608 CH 1H 010B-T	B	36.1/94.1
C257	4030006880	S.CER C1608 JB 1H 472K-T	T	40.7/100.2
C258	4610001830	S.TRI TTB4S100AB10R00	T	36.8/92.6
C259	4030011770	S.CER C1608 CH 1H 060B-T	T	41/94.1
C272	4030007130	S.CER C1608 CH 1H 101J-T	T	17.6/89.7
C273	4030006880	S.CER C1608 JB 1H 472K-T	T	13.8/94.4
C274	4030011340	S.CER C1608 CH 1H 471J-T	T	11/87.9
C275	4030006880	S.CER C1608 JB 1H 472K-T	T	23.2/105.3
C276	4030009510	S.CER C1608 CH 1H 010B-T	B	18.3/94.1
C277	4030006880	S.CER C1608 JB 1H 472K-T	T	23.9/100.2
C278	4610001830	S.TRI TTB4S100AB10R00	T	19.8/92.6
C279	4030007020	S.CER C1608 CH 1H 120J-T	T	24.2/94.1
C300	4030007010	S.CER C1608 CH 1H 100D-T	T	44.8/76.2
C301	4030006880	S.CER C1608 JB 1H 472K-T	T	44.8/74.6
C302	4030007080	S.CER C1608 CH 1H 390J-T	T	40.3/74.2
C304	4030007080	S.CER C1608 CH 1H 390J-T	T	27.1/62.1
C305	4030006980	S.CER C1608 CH 1H 070D-T	T	23.5/65.5
C306	4030007080	S.CER C1608 CH 1H 390J-T	T	22.1/61.5
C307	4030007020	S.CER C1608 CH 1H 120J-T	T	25.8/63.2
C309	4030006880	S.CER C1608 JB 1H 472K-T	T	44.8/72.4
C310	4030006880	S.CER C1608 JB 1H 472K-T	T	53.3/65.5
C311	4030006880	S.CER C1608 JB 1H 472K-T	T	17.8/67.1
C320	4030007080	S.CER C1608 CH 1H 390J-T	T	40.2/70.4
C321	4030007120	S.CER C1608 CH 1H 820J-T	T	42.1/71
C322	4030006880	S.CER C1608 JB 1H 472K-T	T	42.1/66.9
C323	4030006880	S.CER C1608 JB 1H 472K-T	T	29/62.6
C324	4030006880	S.CER C1608 JB 1H 472K-T	T	35.3/61.8
C325	4030011810	S.CER C1608 JB 1A 224K-T	B	32.9/58
C326	4030011600	S.CER C1608 JB 1E 104K-T	T	34/61.8
C327	4030007090	S.CER C1608 CH 1H 470J-T	T	17.3/57.6
C328	4030006990	S.CER C1608 CH 1H 080D-T	T	45.5/68.9
C329	4030007060	S.CER C1608 CH 1H 270J-T	T	44.8/66.9
C330	4030006990	S.CER C1608 CH 1H 080D-T	T	44.8/62.3
C344	4030006880	S.CER C1608 JB 1H 472K-T	T	5.3/63
C345	4030006880	S.CER C1608 JB 1H 472K-T	B	17.4/61.5
C346	4030007090	S.CER C1608 CH 1H 470J-T	T	8.6/61.6
C347	4030006880	S.CER C1608 JB 1H 472K-T	T	7.4/62.7
C350	4030006880	S.CER C1608 JB 1H 472K-T	T	20.6/61.5
C351	4030008560	S.CER C1608 CH 1H 300J-T	T	7.6/70.1
C352	4030009530	S.CER C1608 CH 1H 030B-T	T	10.3/68.3
C353	4030007070	S.CER C1608 CH 1H 330J-T	T	7.6/72.7
C354	4030009520	S.CER C1608 CH 1H 020B-T	T	11.6/74.1
C355	4030007010	S.CER C1608 CH 1H 100D-T	T	10.3/69.6
C356	4030007050	S.CER C1608 CH 1H 220J-T	T	7.6/74
C357	4030006880	S.CER C1608 JB 1H 472K-T	T	3.8/68.1
C358	4030007100	S.CER C1608 CH 1H 560J-T	T	12/76
C359	4030011280	S.CER C1608 CH 1H 271J-T	T	10.7/76
C360	4030007100	S.CER C1608 CH 1H 560J-T	T	11.8/77.9
C361	4030006880	S.CER C1608 JB 1H 472K-T	B	5.3/81.5
C362	4030006880	S.CER C1608 JB 1H 472K-T	T	8/80.7
C363	4030006880	S.CER C1608 JB 1H 472K-T	B	9/80.6
C364	4030006880	S.CER C1608 JB 1H 472K-T	T	8/79.4
C365	4030011600	S.CER C1608 JB 1E 104K-T	T	9.4/82
C380	4550003220	S.TAN TEESVA 1E 105M8L	B	37.4/63.3
C381	4030006880	S.CER C1608 JB 1H 472K-T	T	26.2/65.7
C382	4030007130	S.CER C1608 CH 1H 101J-T	T	20.7/69.3
C384	4030011600	S.CER C1608 JB 1E 104K-T	T	53.3/66.8
C385	4550006080	S.TAN TEESVB2 1C 106M8L	T	50.4/70.5
C386	4550005980	S.TAN TEESVA 1A 475M8L	T	29.1/76.2
C387	4030006880	S.CER C1608 JB 1H 472K-T	T	35.2/71.7
C388	4010006900	CER HE80SJYB 472K 50V	T	
C389	4030011340	S.CER C1608 CH 1H 471J-T	T	28.9/65.5
C390	4550006080	S.TAN TEESVB2 1C 106M8L	T	54.9/63.2
C391	4030011600	S.CER C1608 JB 1E 104K-T	T	57.8/70.7
C392	4030006880	S.CER C1608 JB 1H 472K-T	B	37.1/65.6
C393	4030006880	S.CER C1608 JB 1H 472K-T	T	27.1/73.7
C394	4030006850	S.CER C1608 JB 1H 471K-T	T	36.4/77.6
C395	4030006900	S.CER C1608 JB 1H 103K-T	T	22.8/70.2
C				

[PLL UNIT]

REF NO.	ORDER NO.	DESCRIPTION	M.	H/V LOCATION
C409	4030011600	S.CER C1608 JB 1E 104K-T	T	93.9/7.2
C410	4030011600	S.CER C1608 JB 1E 104K-T	T	104.4/3.5
C411	4030011600	S.CER C1608 JB 1E 104K-T	T	103.1/3.5
C412	4030011600	S.CER C1608 JB 1E 104K-T	T	105.7/3.5
C413	4030011600	S.CER C1608 JB 1E 104K-T	T	114.2/7.1
C414	4030011600	S.CER C1608 JB 1E 104K-T	T	114.2/9.8
C415	4030011600	S.CER C1608 JB 1E 104K-T	T	112.9/20.5
C416	4030011600	S.CER C1608 JB 1E 104K-T	T	97.3/30.1
C417	4030011600	S.CER C1608 JB 1E 104K-T	T	88.5/27.4
C418	4030011600	S.CER C1608 JB 1E 104K-T	T	90/11.8
C419	4030006880	S.CER C1608 JB 1H 472K-T	T	93.1/22.9
C420	4030011600	S.CER C1608 JB 1E 104K-T	T	91.7/17.7
C421	4550006250	S.TAN TEESVA 1A 106M8L	T	93.5/4.1
C422	4030006880	S.CER C1608 JB 1H 472K-T	T	116.2/12.3
C423	4030006880	S.CER C1608 JB 1H 472K-T	T	111.1/3.9
C424	4030006880	S.CER C1608 JB 1H 472K-T	T	111.1/2.6
C425	4030006880	S.CER C1608 JB 1H 472K-T	T	108.9/3
C426	4030006880	S.CER C1608 JB 1H 472K-T	B	106.3/9.9
C427	4030006880	S.CER C1608 JB 1H 472K-T	B	106.3/8
C428	4030006880	S.CER C1608 JB 1H 472K-T	T	107.2/3
C431	4030012600	S.CER C2012 JB 1A 105M-T	B	105.9/2.8
C437	4030006880	S.CER C1608 JB 1H 472K-T	T	83.1/9
C438	4030006880	S.CER C1608 JB 1H 472K-T	B	86.8/5.9
C439	4030006880	S.CER C1608 JB 1H 472K-T	B	87.7/8.3
C447	4030006880	S.CER C1608 JB 1H 472K-T	B	84.8/14
C450	4030011600	S.CER C1608 JB 1E 104K-T	T	79.9/29
C451	4030006880	S.CER C1608 JB 1H 472K-T	T	73.4/31.7
C452	4030007070	S.CER C1608 CH 1H 330J-T	T	76.1/34.8
C453	4030009910	S.CER C1608 CH 1H 040B-T	T	73.4/34.8
C454	4610001850	S.TRI TZB4R200AB10R00	T	69.1/39.2
C455	4030016550	S.CER CM105 CH 151G 50AT	T	72.6/42.7
C456	4030016550	S.CER CM105 CH 151G 50AT	T	66.5/43
C457	4030016550	S.CER CM105 CH 151G 50AT	T	65.2/42.3
C458	4550006080	S.TAN TEESVB2 1C 106M8L	T	63.5/45.9
C459	4030006880	S.CER C1608 JB 1H 472K-T	T	62.6/43
C460	4030006880	S.CER C1608 JB 1H 472K-T	T	71.3/44
C461	4030009920	S.CER C1608 CH 1H 050B-T	T	67.2/34.7
C462	4030011600	S.CER C1608 JB 1E 104K-T	T	65.6/36
C463	4030006880	S.CER C1608 JB 1H 472K-T	T	65.3/33.6
C472	4030006990	S.CER C1608 CH 1H 080D-T	B	104.4/22.2
C473	4030007030	S.CER C1608 CH 1H 150J-T	B	102.6/22.2
C474	4030007060	S.CER C1608 CH 1H 270J-T	B	100.8/22.2
C481	4030006880	S.CER C1608 JB 1H 472K-T	T	55.1/34.5
C482	4550006080	S.TAN TEESVB2 1C 106M8L	T	49.9/30.8
C483	4030006880	S.CER C1608 JB 1H 472K-T	T	54.7/29.6
C491	4030006850	S.CER C1608 JB 1H 471K-T	B	117.3/3.5
C492	4030007130	S.CER C1608 CH 1H 101J-T	B	113.8/7.5
C493	4030009580	S.CER C1608 JB 1H 681K-T	B	115.2/10.1
C494	4030007080	S.CER C1608 CH 1H 390J-T	B	114.8/15.1
C495	4030006850	S.CER C1608 JB 1H 471K-T	B	118.6/9.3
C501	4030006880	S.CER C1608 JB 1H 472K-T	T	40.1/23.5
C502	4030009990	S.CER C1608 CH 1H 200J-T	T	36.1/20.3
C503	4030006880	S.CER C1608 JB 1H 472K-T	T	40.4/15.6
C504	4030011340	S.CER C1608 CH 1H 471J-T	T	41.6/21.9
C505	4030006880	S.CER C1608 JB 1H 472K-T	T	31.1/4.7
C506	4030009510	S.CER C1608 CH 1H 010B-T	B	34.9/15.9
C507	4030006880	S.CER C1608 JB 1H 472K-T	T	30.3/9.8
C508	4610001860	S.TRI TZB4Z060AB10R00	T	33.8/17.4
C509	4030009350	S.CER C1608 CH 1H 3R5B-T	T	30.1/15.8
C522	4030007100	S.CER C1608 CH 1H 560J-T	T	18.9/20.3
C523	4030006880	S.CER C1608 JB 1H 472K-T	T	23.6/15.6
C524	4030011340	S.CER C1608 CH 1H 471J-T	T	24.7/21.9
C525	4030006880	S.CER C1608 JB 1H 472K-T	T	14.2/4.7
C526	4030009510	S.CER C1608 CH 1H 010B-T	B	18.6/15.9
C527	4030006880	S.CER C1608 JB 1H 472K-T	T	13.4/9.8
C528	4610001830	S.TRI TZB4S100AB10R00	T	17.2/17.4
C529	4030009920	S.CER C1608 CH 1H 050B-T	T	13.3/15.8
C552	4030007150	S.CER C1608 CH 1H 151J-T	T	52.9/20.3
C553	4030006880	S.CER C1608 JB 1H 472K-T	T	57.2/15.6
C554	4030011340	S.CER C1608 CH 1H 471J-T	T	58.4/21.8
C555	4030006880	S.CER C1608 JB 1H 472K-T	T	47.8/4.7
C556	4030009510	S.CER C1608 CH 1H 010B-T	B	51.7/15.9
C557	4030006880	S.CER C1608 JB 1H 472K-T	T	47/9.8
C558	4610001830	S.TRI TZB4S100AB10R00	T	51/17.4
C559	4030011770	S.CER C1608 CH 1H 060B-T	T	46.9/15.8
C572	4030007130	S.CER C1608 CH 1H 101J-T	T	69.7/20.3
C573	4030006880	S.CER C1608 JB 1H 472K-T	T	74/15.6
C574	4030011340	S.CER C1608 CH 1H 471J-T	T	76.8/21.8
C575	4030006880	S.CER C1608 JB 1H 472K-T	T	64.6/4.7
C576	4030009510	S.CER C1608 CH 1H 010B-T	B	68.6/15.9
C577	4030006880	S.CER C1608 JB 1H 472K-T	T	63.8/9.8
C578	4610001830	S.TRI TZB4S100AB10R00	T	68/17.4
C579	4030007020	S.CER C1608 CH 1H 120J-T	T	63.8/15.9
C600	4030007010	S.CER C1608 CH 1H 100D-T	T	44.6/35.5
C601	4030006880	S.CER C1608 JB 1H 472K-T	T	44.6/34.2
C602	4030007080	S.CER C1608 CH 1H 390J-T	T	41.8/36.9
C604	4030007080	S.CER C1608 CH 1H 390J-T	T	22.1/47.5
C605	4030006980	S.CER C1608 CH 1H 070D-T	T	18.9/42.9
C606	4030007080	S.CER C1608 CH 1H 390J-T	T	19.9/49
C607	4030007020	S.CER C1608 CH 1H 120J-T	T	23.4/47.5
C609	4030006880	S.CER C1608 JB 1H 472K-T	T	44.6/32.6
C610	4030006880	S.CER C1608 JB 1H 472K-T	B	45.2/34.1
C611	4030006880	S.CER C1608 JB 1H 472K-T	T	18.9/41.6

M.=Mounted side (T: Mounted on the Top side, B: Mounted on the Bottom side)

[PLL UNIT]

REF NO.	ORDER NO.	DESCRIPTION	M.	H/V LOCATION
C620	4030007080	S.CER C1608 CH 1H 390J-T	T	41.8/39.5
C621	4030007120	S.CER C1608 CH 1H 820J-T	T	41.8/38.2
C622	4030006880	S.CER C1608 JB 1H 472K-T	T	41.8/42.1
C623	4030006880	S.CER C1608 JB 1H 472K-T	T	28.6/48.7
C624	4030006880	S.CER C1608 JB 1H 472K-T	T	34.3/47.2
C625	4030011810	S.CER C1608 JB 1A 224K-T	B	33.2/51.7
C626	4030011600	S.CER C1608 JB 1E 104K-T	T	35.6/46.1
C627	4030006990	S.CER C1608 CH 1H 080D-T	T	44.6/42.1
C628	4030007060	S.CER C1608 CH 1H 270J-T	T	44.6/43.4
C629	4030006990	S.CER C1608 CH 1H 080D-T	T	44.8/48.2
C644	4030006880	S.CER C1608 JB 1H 472K-T	T	6.4/46.8
C645	4030006880	S.CER C1608 JB 1H 472K-T	T	1.7/34.2
C650	4030006880	S.CER C1608 JB 1H 472K-T	T	27.3/48.7
C651	4030008560	S.CER C1608 CH 1H 300J-T	T	7.9/41.7
C652	4030009520	S.CER C1608 CH 1H 030B-T	T	9.8/40.9
C653	4030007070	S.CER C1608 CH 1H 330J-T	T	7.9/40.4
C654	4030009520	S.CER C1608 CH 1H 020B-T	T	11.1/34.7
C655	4030007010	S.CER C1608 CH 1H 100D-T	T	10.6/38.5
C656	4030007050	S.CER C1608 CH 1H 220J-T	T	6.6/36.6
C657	4030006880	S.CER C1608 JB 1H 472K-T	T	6.4/45.5
C658	4030007100	S.CER C1608 CH 1H 560J-T	T	8.4/34.7
C659	4030011280	S.CER C1608 CH 1H 271J-T	T	5.7/34.7
C660	4030007100	S.CER C1608 CH 1H 560J-T	T	8.4/33.4
C661	4030006880	S.CER C1608 JB 1H 472K-T	B	8.9/29.6
C662	4030006880	S.CER C1608 JB 1H 472K-T	B	1.7/28.5
C663	4030006880	S.CER C1608 JB 1H 472K-T	B	5.7/34.3
C664	4030006880	S.CER C1608 JB 1H 472K-T	T	13.4/29.7
C665	4030011600	S.CER C1608 JB 1E 104K-T	T	13.4/32.4
C680	4550003220	S.TAN TEESVA 1E 105M8L	B	37.1/46.2
C681	4030006880	S.CER C1608 JB 1H 472K-T	T	36.1/47.3
C682	4030007130	S.CER C1608 CH 1H 101J-T	T	20/37.7
C684	4030011600	S.CER C1608 JB 1E 104K-T	T	50.3/42.8
C685	4550006080	S.TAN TEESVB2 1C 106M8L	T	50.7/46.3
C686	4550005980	S.TAN TEESVA 1A 475M8L	T	31.8/33.4
C689	4030011340	S.CER C1608 CH 1H 471J-T	T	26.9/43.8
C690	4550006080	S.TAN TEESVB2 1C 106M8L	T	55.4/45.1
C691	4030011600	S.CER C1608 JB 1E 104K-T	T	56/41.9
C694	4030011340	S.CER C1608 CH 1H 471J-T	T	27.4/33
C695	4030006900	S.CER C1608 JB 1H 103K-T	T	35.9/40.5
C696	4550006480	S.TAN TEESVA 1C 475M8L	T	30.7/44.3
C697	4030006880	S.CER C1608 JB 1H 472K-T	T	26.9/45.1
C698	4030006880	S.CER C1608 JB 1H 472K-T	T	26/37.6
C701	4550006080	S.TAN TEESVB2 1C 106M8L	B	133.8/31.8
C702	4030011600	S.CER C1608 JB 1E 104K-T	T	138.6/28
C703	4030011600	S.CER C1608 JB 1E 104K-T	T	144.2/29.9
C704	4030011600	S.CER C1608 JB 1E 104K-T	T	146.1/34.1
C705	4030011600	S.CER C1608 JB 1E 104K-T	T	146.9/39
C706	4030011600	S.CER C1608 JB 1E 104K-T	T	131.3/42
C707	4030011600	S.CER C1608 JB 1E 104K-T	T	129.1/39.6
C708	4030006880	S.CER C1608 JB 1H 472K-T	T	142.3/27.2
C709	4030011340	S.CER C1608 CH 1H 471J-T	T	134.6/49.8
C710	4030007120	S.CER C1608 CH 1H 820J-T	T	132.2/47.2
C711	4030009580	S.CER C1608 JB 1H 681K-T	T	133.3/49.8
C712	4030007070	S.CER C1608 CH 1H 330J-T	T	129.9/50.5
C713	4030010040	S.CER C1608 JB 1H 561K-T	T	129.9/51.8
C714	4030011280	S.CER C1608 CH 1H 271J-T	T	133.8/51.8
C715	4030006860	S.CER C1608 JB 1H 102K-T	T	133.8/53.1
C716	4030011280	S.CER C1608 CH 1H 271J-T	T	135.7/52.5
C801	4550006080	S.TAN TEESVB2 1C 106M8L	B	130.5/13.8
C802	4030011600	S.CER C1608 JB 1E 104K-T	T	123.3/13.2
C803	4030011600	S.CER C1608 JB 1E 104K-T	B	124.8/11.1
C804	4030011600	S.CER C1608 JB 1E 104K-T	T	132.5/5.1
C805	4030011600	S.CER C1608 JB 1E 104K-T	T	136.3/6.2
C806	4030011600	S.CER C1608 JB 1E 104K-T	B	135.5/12.7
C807	4030011600	S.CER C1608 JB 1E 104K-T	T	134.3/20.7
C808	4030006880	S.CER C1608 JB 1H 472K-T	T	122.6/5.1
C809	4030007030	S.CER C1608 CH 1H 150J-T	T	145.9/17.7
C810	4030006970	S.CER C1608 CH 1H 060D-T	T	143.2/19
C811	4030007060	S.CER C1608 CH 1H 270J-T	T	145.9/19
C812	4030009520	S.CER C1608 CH 1H 020B-T	B	138.4/20.8
C813	4030007040	S.CER C1608 CH 1H 180J-T	T	145.9/20.3
C814	4030007040	S.CER C1608 CH 1H 180J-T	T	150.7/13
C815	4030007090	S.CER C1608 CH 1H 470J-T	T	154.2/10.4
C816	4030007040	S.CER C1608 CH 1H 180J-T	T	153.4/13
C817	4030006880	S.CER C1608 JB 1H 472K-T	T	153.4/15.6
C818	4030006880	S.CER C1608 JB 1H 472K-T	T	150.7/18.2
C826	4030011280	S.CER C1608 CH 1H 271J-T	T	153.5/20.8
C827	4030011280	S.CER C1608 CH 1H 271J-T	T	153.5/23.4
C901	4030006880	S.CER C1608 JB 1H 472K-T	T	95.1/49.5
C902	4550006080	S.TAN TEESVB2 1C 106M8L	T	94.5/53.7
C903	4030007130	S.CER C1608 CH 1H 101J-T	T	105.5/47
C905	4030009580	S.CER C1608 JB 1H 681K-T	T	92.8/42.5
C906	4030011280	S.CER C1608 CH 1H 271J-T	T	92.3/

[PLL UNIT]

REF NO.	ORDER NO.	DESCRIPTION	M.	H/V LOCATION
C918	4030007020	S.CER C1608 CH 1H 120J-T	T	113.1/46.2
C919	4030009910	S.CER C1608 CH 1H 040B-T	T	108/42.1
C920	4030006880	S.CER C1608 JB 1H 472K-T	T	112.4/49.8
C921	4030006880	S.CER C1608 JB 1H 472K-T	T	111.8/43.5
C922	4550006080	S.TAN TEESVB2 1C 106M8L	B	111.4/46
C923	4030006880	S.CER C1608 JB 1H 472K-T	T	109.9/43.2
C924	4030006880	S.CER C1608 JB 1H 472K-T	T	106.1/41.6
C925	4030006880	S.CER C1608 JB 1H 472K-T	T	107.9/39
C926	4030007170	S.CER C1608 CH 1H 221J-T	T	116.3/39.5
C927	4030006860	S.CER C1608 JB 1H 102K-T	T	118.1/42.7
C928	4030007100	S.CER C1608 CH 1H 560J-T	T	120.5/46
C929	4030009910	S.CER C1608 CH 1H 040B-T	T	120.5/44.7
C930	4030007130	S.CER C1608 CH 1H 101J-T	T	120.2/47.3
C931	4030007020	S.CER C1608 CH 1H 120J-T	T	117.6/39.5
C932	4030007100	S.CER C1608 CH 1H 560J-T	T	121.4/40.3
C934	4030011600	S.CER C1608 JB 1E 104K-T	T	120.5/48.6
C935	4030006880	S.CER C1608 JB 1H 472K-T	T	121.6/55.3
C936	4550006080	S.TAN TEESVB2 1C 106M8L	B	119.2/50.1
J1	6510022610	S.CNR 16FMN-BMTR-A-TBT	T	152.2/70
W1	7030003860	S.RES ERJ3GE JPW V	T	131.9/55.1
W2	7030003860	S.RES ERJ3GE JPW V	T	146.3/55.3
W6	7030003860	S.RES ERJ3GE JPW V	T	144/20.9
W10	7030003860	S.RES ERJ3GE JPW V	T	141/80.3
W25	7030003860	S.RES ERJ3GE JPW V	T	139.5/52.4
W28	7030003860	S.RES ERJ3GE JPW V	T	142.1/52.4
W29	7030003860	S.RES ERJ3GE JPW V	T	141.1/55.1
W32	7030003860	S.RES ERJ3GE JPW V	T	116.5/14.2
W33	7030003860	S.RES ERJ3GE JPW V	T	96.2/70.2
W51	7030003860	S.RES ERJ3GE JPW V	B	145.6/102.6
W92	7030003860	S.RES ERJ3GE JPW V	T	148.2/59.6
W121	7030003860	S.RES ERJ3GE JPW V	T	119.3/97.7
W122	7030003860	S.RES ERJ3GE JPW V	T	92.1/96.6
W151	7030008240	S.RES ERJ12YJ0R00U	B	77.9/106.7
W155	7030003860	S.RES ERJ3GE JPW V	T	54.5/59.5
W170	7030008240	S.RES ERJ12YJ0R00U	B	98.6/96
W181	7030003860	S.RES ERJ3GE JPW V	T	50.7/79.6
W201	7030003970	S.RES MCR18EZHH JPW	B	55.9/106.6
W202	7030008240	S.RES ERJ12YJ0R00U	B	65.9/92.5
W221	7030000010	S.RES MCR10EZHH JPW (000)	B	40.7/106.9
W222	7030008240	S.RES ERJ12YJ0R00U	B	49.4/92.5
W251	7030000010	S.RES MCR10EZHH JPW (000)	B	25.4/106.9
W252	7030008240	S.RES ERJ12YJ0R00U	B	33.1/92.3
W351	9009130046	WIR 62/99/160/C24/C31		
W381	7030008240	S.RES ERJ12YJ0R00U	B	41.7/62.3
W382	7030008240	S.RES ERJ12YJ0R00U	B	34.9/67.2
W385	7030003860	S.RES ERJ3GE JPW V	T	40.2/72.3
W392	7030003860	S.RES ERJ3GE JPW V	T	32.2/73.7
W422	7030003860	S.RES ERJ3GE JPW V	T	89.8/18.4
W451	7030008240	S.RES ERJ12YJ0R00U	B	77.7/3.2
W452	7030008240	S.RES ERJ12YJ0R00U	B	84.9/25.7
W455	7030003860	S.RES ERJ3GE JPW V	T	61.6/32
W481	7030003860	S.RES ERJ3GE JPW V	T	56/32.4
W521	7030000010	S.RES MCR10EZHH JPW (000)	B	32.2/2.7
W522	7030008240	S.RES ERJ12YJ0R00U	B	21.7/17.5
W551	7030000010	S.RES MCR10EZHH JPW (000)	B	47.3/2.8
W552	7030008240	S.RES ERJ12YJ0R00U	B	38/17.5
W571	7030003970	S.RES MCR18EZHH JPW	B	62.1/3
W572	7030008240	S.RES ERJ12YJ0R00U	B	54.8/17.5
W681	7030003860	S.RES ERJ3GE JPW V	B	40.9/39.3
W682	7030003860	S.RES ERJ3GE JPW V	B	42.9/42.3
W683	7030008240	S.RES ERJ12YJ0R00U	B	31.4/40.5
W692	7030003860	S.RES ERJ3GE JPW V	T	28.7/35.7
W821	7030003860	S.RES ERJ3GE JPW V	T	150.8/24.6
W851	8970024590	WIR 1.5D 180MM		
W951	7030000010	S.RES MCR10EZHH JPW (000)	T	83.8/45.7
W952	7030000010	S.RES MCR10EZHH JPW (000)	T	85/75.5
W963	7030003860	S.RES ERJ3GE JPW V	B	111.5/63.6
W964	7030003860	S.RES ERJ3GE JPW V	B	111.6/65.5
W965	7030003860	S.RES ERJ3GE JPW V	B	131.2/59.4
W966	7030003860	S.RES ERJ3GE JPW V	B	131.2/57.6
EP1	0910051799	PCB B 5241I		
EP151	6910012350	S.BEA MMZ1608Y 102BT	B	74.4/62.3
EP204	6910012350	S.BEA MMZ1608Y 102BT	B	71.1/101.2
EP224	6910012350	S.BEA MMZ1608Y 102BT	B	62.8/105.3
EP254	6910012350	S.BEA MMZ1608Y 102BT	B	48.1/105.7
EP274	6910012350	S.BEA MMZ1608Y 102BT	B	20.7/101.2
EP321	6910012350	S.BEA MMZ1608Y 102BT	T	32.9/59.8
EP351	6910012350	S.BEA MMZ1608Y 102BT	T	9.8/58.8
EP357	6910012350	S.BEA MMZ1608Y 102BT	T	7.6/68.8
EP451	6910012350	S.BEA MMZ1608Y 102BT	B	63.8/47.1
EP504	6910012350	S.BEA MMZ1608Y 102BT	B	37/4.6
EP524	6910012350	S.BEA MMZ1608Y 102BT	B	20.5/4.3
EP554	6910012350	S.BEA MMZ1608Y 102BT	B	53.9/4.4
EP574	6910012350	S.BEA MMZ1608Y 102BT	B	71/4.1
EP621	6910012350	S.BEA MMZ1608Y 102BT	B	33.2/49.9

M.=Mounted side (T: Mounted on the Top side, B: Mounted on the Bottom side)

[PA UNIT]

REF NO.	ORDER NO.	DESCRIPTION	M.	H/V LOCATION
IC1	1180001070	S.IC TA7805F (TE16L)	T	20.3/71.4
IC2	1110002020	IC TA7805S	T	9.4/86.6
IC3	1180001980	IC MC78T08CT	T	40.6/86.5
Q1	1530000790	TR 2SC1971	T	21.5/52.7
Q2	1530000800	TR 2SC1972	T	40.5/59
Q3	1530000800	TR 2SC1972	T	40.5/26.6
Q4	1530003740	TR 2SC5125	T	103/49
Q5	1530003740	TR 2SC5125	T	103/17
Q8	1540000500	TR 2SD1585K	T	99.2/72.3
Q9	1590003280	S.TR UNR9211J-(TX)	T	54.4/72
Q10	1530002060	S.TR 2SC4081 T106 R	T	48/12.4
Q11	1530002060	S.TR 2SC4081 T106 R	T	62.5/115.7
Q12	1520000650	S.TR 2SB1201-S-TL	T	53.2/8.3
Q13	1520000650	S.TR 2SB1201-S-TL	T	67.4/17.3
D1	1790000710	VSR MA29B	T	18/59.5
D2	1790000710	VSR MA29B	T	44/65.3
D3	1790000710	VSR MA29B	T	43.9/59.1
D4	1790000700	DIO DSA3A1	T	130.2/69.4
D5	1790000700	DIO DSA3A1	T	112.1/74
D7	1160000140	S.DIO DAP222 TL	T	53/74.8
D8	1790000700	DIO DSA3A1	T	130.2/75.9
D10	1710000970	DIO MA185	T	72/8.3
D61	1750000520	S.DIO DAN222TL	T	7.6/6.5
L1	6140003240	COL LR-361	T	23.3/37.5
L2	2040000490	COL EXC-ELDR25C	T	28.6/54.2
L3	2040000490	COL EXC-ELDR25C	T	31.7/54.8
L4	6140001180	COL LR-143	T	65.3/33
L5	2040000490	COL EXC-ELDR25C	T	62.3/56.6
L6	6140003510	COL LR-393	T	139.9/33
L7	6140000610	COL LR-83	T	106.5/33
L8	6140002030	COL LR-230 (SK-10M-15Y 120)	T	148/53.9
L9	2040000490	COL EXC-ELDR25C	T	74.8/48
L10	2040000490	COL EXC-ELDR25C	T	74.8/17.9
L12	2040000490	COL EXC-ELDR25C	T	82.3/72.9
L14	6140003230	S.COL LR-360	T	10/42.6
L15	6910000670	COL BL01RN1A1D2B		
L16	6910000670	COL BL01RN1A1D2B		
L21	6110001730	COL LA-262	T	123/55
L22	2040000490	COL EXC-ELDR25C	T	67.3/45.2
R1	7030003380	S.RES ERJ3GEYJ 331 V (330 Ω)	T	11.6/34.4
R2	7030003230	S.RES ERJ3GEYJ 180 V (18 Ω)	T	9.6/35.2
R3	7030003380	S.RES ERJ3GEYJ 331 V (330 Ω)	T	11.6/36
R4	7030003360	S.RES ERJ3GEYJ 221 V (220 Ω)	T	12.6/51.4
R5	7030003390	S.RES ERJ3GEYJ 391 V (390 Ω)	T	13.4/49.2
R6	7030003360	S.RES ERJ3GEYJ 221 V (220 Ω)	T	13.4/47.9
R7	7030006210	S.RES ERJ12YJ4R7U (4.7 Ω)	T	16/38.8
R8	7030008230	S.RES ERJ1WYJ10U (1 Ω)	T	31.2/44
R9	7030008230	S.RES ERJ1WYJ10U (1 Ω)	T	32.8/24.1
R10	7030003420	S.RES ERJ3GEYJ 681 V (680 Ω)	T	16.7/41.3
R11	7310004740	TRI EVM-2AGA00 B52 (501)	T	50.9/80.5
R12	7030003300	S.RES ERJ3GEYJ 680 V (68 Ω)	T	42/72.6
R13	7030000220	S.RES MCR10EZHH 47 Ω (470)	T	34.2/47.4
R14	7030000220	S.RES MCR10EZHH 47 Ω (470)	T	30.5/18.8
R15	7030006180	S.RES ERJ1WYJ10U (100 Ω)	T	47.1/44.6
R16	7030006180	S.RES ERJ1WYJ10U (100 Ω)	T	41.4/12.5
R17	7030006130	S.RES ERJ1WYJ100U (10 Ω)	T	62.9/50.6
R18	7310004710	TRI EVM-2AGA00 B23 (202)	T	77.4/64.1
R19	7030003400	S.RES ERJ3GEYJ 471 V (470 Ω)	T	73.6/63.8
R20	7030010950	S.RES ERJ1TYJ 100U (10 Ω)	T	77.9/52.6
R21	7030010950	S.RES ERJ1TYJ 100U (10 Ω)	T	77.9/56.4
R23	7030010950	S.RES ERJ1TYJ 100U (10 Ω)	T	77.9/13.4
R24	7030010950	S.RES ERJ1TYJ 100U (10 Ω)	T	77.9/9.6
R26	7030006060	S.RES ERJ12YJ100U (10 Ω)	T	86.5/43.4
R27	7030006060	S.RES ERJ12YJ100U (10 Ω)	T	86.5/22.7
R28	7100000640	RES 5 S1 0.012 Ω (J)		
R29	7030003440	S.RES ERJ3GEYJ 102 V (1 kΩ)	T	129.8/81.3
R31	7030003440	S.RES ERJ3GEYJ 102 V (1 kΩ)	T	154.4/81.6
R32	7030007630	S.RES MCR100JZHJ 0.68 Ω (R68)	T	83.7/51
R33	7030007630	S.RES MCR100JZHJ 0.68 Ω (R68)	T	87.4/51
R34	7030007630	S.RES MCR100JZHJ 0.68 Ω (R68)	T	83.7/15
R35	7030007630	S.RES MCR100JZHJ 0.68 Ω (R68)	T	87.4/15
R38	7030006120	S.RES ERJ1WYJ4R7U (4.7 Ω)	T	162.4/54.5
R39	7030006120	S.RES ERJ1WYJ4R7U (4.7 Ω)	T	162.4/58.2
R40	7030006120	S.RES ERJ1WYJ4R7U (4.7 Ω)	T	162.4/61.9
R41	7030010470	S.RES ERJ1TYJ 5R6U (5.6 Ω)	T	85.8/37.6
R42	7030010470	S.RES ERJ1TYJ 5R6U (5.6 Ω)	T	85.8/28.1
R44	7070000681	RES ERX3SJ 3R9 (3.9 Ω)	T	3.2/86.1
R45	7030005341	S.RES ERA3YED 332V	T	55/15.1
R46	7030008071	S.RES ERA3YED 273V	T	56.9/14.3
R47	7030005981	S.RES ERA3YED 333V	T	59.7/13.6
R48	7030008061	S.RES ERA3YED 222V	T	62.4/13.6
R49	7030003440	S.RES ERJ3GEYJ 102 V (1 kΩ)	T	46/8.8
R50	7510000070	TMR ERT-D2FHL 503S	T	93.5/3.7
R51	7030006140	S.RES ERJ1WYJ560U (56 Ω)	T	62/9
R52	7030006060	S.RES ERJ12YJ100U (10 Ω)	T	56.8/18.7

S.=Surface mount

[PA UNIT]

REF NO.	ORDER NO.	DESCRIPTION	M.	H/V LOCATION
R53	7030003440	S.RES ERJ3GEYJ 102 V (1 kΩ)	T	61.2/17.7
R54	7030003440	S.RES ERJ3GEYJ 102 V (1 kΩ)	T	47.9/9.7
R55	7030003560	S.RES ERJ3GEYJ 103 V (10 kΩ)	T	47.8/6.3
R56	7030003560	S.RES ERJ3GEYJ 103 V (10 kΩ)	T	61.6/19.7
R57	7030006270	S.RES ERJ12YJ221U (220 Ω)	T	19.7/33
R58	7030003360	S.RES ERJ3GEYJ 221 V (220 Ω)	T	10.7/46.8
C1	4030011600	S.CER C1608 JB 1E 104K-T	T	14/45
C2	4030006860	S.CER C1608 JB 1H 102K-T	T	11.4/48.7
C3	4030011600	S.CER C1608 JB 1E 104K-T	T	10.6/50.6
C4	4030006860	S.CER C1608 JB 1H 102K-T	T	16.4/36.3
C5	4030011600	S.CER C1608 JB 1E 104K-T	T	18.9/28.7
C6	4030006860	S.CER C1608 JB 1H 102K-T	T	20.2/28.7
C7	4030006880	S.CER C1608 JB 1H 472K-T	T	14.4/42.1
C8	4510004640	S.ELE ECEV1CA470SP	T	37.1/75.5
C9	4030011600	S.CER C1608 JB 1E 104K-T	T	33.9/59.4
C10	4030005010	S.CER C2012 CH 1H 151J-T	T	33/34.1
C11	4030012490	S.CER GRM31M1X2A472JZ01L	T	37.7/46.9
C12	4030012490	S.CER GRM31M1X2A472JZ01L	T	33.5/15.8
C14	4030011600	S.CER C1608 JB 1E 104K-T	T	58.2/58.6
C15	4030011600	S.CER C1608 JB 1E 104K-T	T	79.9/73.6
C16	4510004630	S.ELE ECEV1CA100SR	T	76.4/75.9
C17	4030008920	S.CER C1608 JB 1H 473K-T	T	41.4/65.3
C18	4030008920	S.CER C1608 JB 1H 473K-T	T	41.5/59
C20	4030011600	S.CER C1608 JB 1E 104K-T	T	81/66.5
C21	4030012620	S.CER GRM55R2C2H102JV01L	T	79.6/42.5
C22	4030012620	S.CER GRM55R2C2H102JV01L	B	80/43.6
C23	4030012620	S.CER GRM55R2C2H102JV01L	T	79.6/23.3
C24	4030012620	S.CER GRM55R2C2H102JV01L	B	79.6/22.2
C25	4030011740	S.CER GRM32N2C2H201JV01L	T	116.7/33
C27	4030008920	S.CER C1608 JB 1H 473K-T	T	20.4/59.5
C30	4030004760	S.CER C2012 JF 1H 104Z-T	T	122.7/66.1
C33	4030006880	S.CER C1608 JB 1H 472K-T	T	152.4/80.8
C34	4030006880	S.CER C1608 JB 1H 472K-T	T	134.2/81.3
C35	4030005110	S.CER C2012 JB 1E 473K-T	T	120.9/66.1
C36	4510004600	ELE 16 MV 1000 HC	T	114.7/68
C37	4030011600	S.CER C1608 JB 1E 104K-T	T	159/81
C39	4510004600	ELE 16 MV 1000 HC	T	154.8/74
C40	4510004600	ELE 16 MV 1000 HC	T	160.6/72
C41	4030006860	S.CER C1608 JB 1H 102K-T	T	14/46.3
C42	4030011600	S.CER C1608 JB 1E 104K-T	T	54.7/74.7
C57	4030011740	S.CER GRM32N2C2H201JV01L	T	119.7/33
C58	4030018370	S.CER ERF22X 6C1H 102J D01L	T	76.7/32.9
C59	4030011740	S.CER GRM32N2C2H201JV01L	T	113.7/33
C60	4030011740	S.CER GRM32N2C2H201JV01L	T	110.7/33
C61	4030012620	S.CER GRM55R2C2H102JV01L	B	79.9/52.2
C62	4030012620	S.CER GRM55R2C2H102JV01L	B	79.6/13.3
C71	4030011600	S.CER C1608 JB 1E 104K-T	T	26/66.8
C72	4030011600	S.CER C1608 JB 1E 104K-T	T	31.6/76.7
C73	4510004630	S.ELE ECEV1CA100SR	T	30/68.8
C74	4510004630	S.ELE ECEV1CA100SR	T	30/73.6
C75	4030011600	S.CER C1608 JB 1E 104K-T	T	11.2/83.8
C76	4030011600	S.CER C1608 JB 1E 104K-T	T	17.9/85.7
C77	4510006220	S.ELE ECEV1CA101UP	T	15.6/80.9
C78	4510006220	S.ELE ECEV1CA101UP	T	22.7/85.4
C79	4030011600	S.CER C1608 JB 1E 104K-T	T	37.1/81.2
C80	4030011600	S.CER C1608 JB 1E 104K-T	T	50.1/84.6
C81	4510004630	S.ELE ECEV1CA100SR	T	41.3/81.6
C82	4510004630	S.ELE ECEV1CA100SR	T	46.2/81.6
C89	4030011600	S.CER C1608 JB 1E 104K-T	T	50.6/74.1
C93	4030011600	S.CER C1608 JB 1E 104K-T	T	43/6.2
C94	4030006880	S.CER C1608 JB 1H 472K-T	T	59.7/15.5
C95	4030006880	S.CER C1608 JB 1H 472K-T	T	47.8/14.4
C96	4510005000	ELE 16 MV 220 HC	T	67.4/6.1
C97	4030006880	S.CER C1608 JB 1H 472K-T	T	71.8/12.2
C99	4510004590	ELE 16 MV 470 HC	T	148.3/9.8
C100	4030006880	S.CER C1608 JB 1H 472K-T	T	60.3/20.9
C101	4030006880	S.CER C1608 JB 1H 472K-T	T	63.2/18.5
C102	4030006880	S.CER C1608 JB 1H 472K-T	T	46.5/6.3
C103	4510004630	S.ELE ECEV1CA100SR	T	51.5/15.7
C105	4510006220	S.ELE ECEV1CA101UP	T	24.8/23.1
C107	4030006880	S.CER C1608 JB 1H 472K-T	T	157.7/81
C108	4030006880	S.CER C1608 JB 1H 472K-T	T	10.9/12.8
C109	4030006880	S.CER C1608 JB 1H 472K-T	T	12.2/12.8
C110	4030006880	S.CER C1608 JB 1H 472K-T	T	13.5/12.8
C111	4030006880	S.CER C1608 JB 1H 472K-T	T	14.8/13.8
C112	4030006880	S.CER C1608 JB 1H 472K-T	T	16.1/14.4
C113	4030006880	S.CER C1608 JB 1H 472K-T	T	17.4/14.4
C114	4030006880	S.CER C1608 JB 1H 472K-T	T	18.7/14.4
C115	4030006880	S.CER C1608 JB 1H 472K-T	T	25.1/13.2
C116	4030011730	S.CER GRM31M2C2H101JV01L	T	9.7/38.1
C117	4030007090	S.CER C1608 CH 1H 470J-T	T	119.3/52
C118	4030012480	S.CER GRM31M2C2H121JV01L	T	119.3/14
C119	4030012480	S.CER GRM31M2C2H121JV01L	T	49.2/35.4
C120	4010005830	CER HM74SJ SL 151J 500V	T	75.7/69.2
C121	4510004640	S.ELE ECEV1CA470SP	T	17/34.1
C122	4030004910	S.CER C2012 CH 1H 220J-T	T	126.2/64.2
C123	4030011170	S.CER GRM31M2C2H180JV01L	T	57.5/85.8
RL1	6330001160	RLY AJV5341 (JV1AP-DC12V)	T	

M.=Mounted side (T: Mounted on the Top side, B: Mounted on the Bottom side)

[PA UNIT]

REF NO.	ORDER NO.	DESCRIPTION	M.	H/V LOCATION
J3	6510022600	S.CNR 30FMN-BMTTR-A-TBT	T	25.4/7.6
J10	6510003080	CNR RT01T-1.0B	T	93/27.7
J11	6510018960	S.CNR B2B-PH-SM3-TB	T	138.3/10.8
F1	5210000060	FUS FGB 5A (FGB0 125V)		
F2	5220000230	HOL S-N5054	T	109.8/86
F3	5220000230	HOL S-N5054	T	78.8/86
W29	9045201001	WIR 74/98/040/X98/X98	T	58.6/46.4
W30	9021780060	WIR 74/98/018/X98/X98		
W31	9021780060	WIR 74/98/018/X98/X98		
WS1	8970023490	SX2178 1.5D COAXIAL TUBE (1)/PA		
WS2	8970023500	SX2178 1.5D COAXIAL TUBE (1)/PA		
WS3	8970023510	SX2178 J BOARD SET (1)/PA		
EP1	0910051815	PCB B 5294E		
EP2	6910000610	BEA FSRH050100RN000B		
EP3	6910000610	BEA FSRH050100RN000B		
EP4	6510018330	TER F4053A	T	118/85.3
EP5	6510018330	TER F4053A	T	140.2/72.7
EP8	9021002002	TUB IRRAX 1.5 (d) L=10 mm		
EP9	9021002002	TUB IRRAX 1.5 (d) L=10 mm		
EP10	9006400002	TUB IRRAX 1.5 (d) L=21 mm		
EP11	9034701901	TUB IRRAX 0.7 (d) L=20 mm		
EP12	0910052242	PCB B 5447B		
EP13	0910052341	PCB B 5449A		
EP14	0910052351	PCB B 5450A		

[MEMORY UNIT]

REF NO.	ORDER NO.	DESCRIPTION	M.	H/V LOCATION
IC1	1140008630	S.IC MBM29F400BC-90PFTN SC-1380	B	28.9/9.4
IC2	1140008470	S.IC IDT71256SA20PZ	B	28.6/23.7
R1	7030003680	S.RES ERJ3GEYJ 104 V (100 kΩ)	B	14.4/25.7
R2	7030003680	S.RES ERJ3GEYJ 104 V (100 kΩ)	B	13.1/25.7
C1	4030011600	S.CER C1608 JB 1E 104K-T	B	17.1/3.5
C2	4030006860	S.CER C1608 JB 1H 102K-T	B	16.6/15.9
C3	4550006250	S.TAN TEESVA 1A 106M8L	B	14.9/17.4
C4	4030011600	S.CER C1608 JB 1E 104K-T	B	38/23.7
J1	6510022070	S.CNR AXK6S30635P	B	50/14
J2	6510022070	S.CNR AXK6S30635P	B	10/14
EP1	6910012350	S.BEA MMZ1608Y 102BT	B	49.2/6.4
EP2	0910052263	PCB B 5418C		

S.=Surface mount

[MAIN-A UNIT]

REF NO.	ORDER NO.	DESCRIPTION	M.	H/V LOCATION
IC101	1110000960	S.IC NJM4558M-TE1	T	88.3/26.5
IC151	1130006220	S.IC TC4W53FU (TE12L)	T	44.9/93
IC152	1130003610	S.IC TC4SU69F (TE85R)	T	52.5/93.7
IC153	1130003610	S.IC TC4SU69F (TE85R)	T	48.7/93.7
IC201	1110005420	S.IC BA15532F-E2	T	36.9/113.5
IC221	1110004840	S.IC NJM1496V-TE1	T	36.7/90.6
IC301	1130006220	S.IC TC4W53FU (TE12L)	T	97.1/113.8
IC311	1110003300	S.IC M5282FP 70CD	B	84.3/109.4
IC321	1110000960	S.IC NJM4558M-TE1	T	112.5/81
IC331	1130006220	S.IC TC4W53FU (TE12L)	T	83.2/136.2
IC332	1110003090	IC LA4425A	T	86.1/48.8
IC361	1130006220	S.IC TC4W53FU (TE12L)	T	90/94.8
IC362	1130006220	S.IC TC4W53FU (TE12L)	T	104.8/84.9
IC371	1110003300	S.IC M5282FP 70CD	B	76.9/101.7
IC372	1110003670	S.IC BA3308F-E2	B	65.8/102.2
IC451	1140005280	S.IC μPC5023GS-077-E1	B	130.2/118.5
IC551	1110003870	S.IC NJM2058M-TE1	B	91.1/44.5
IC571	1110000960	S.IC NJM4558M-TE1	B	92.8/32
IC801	1180002000	REG BA033T	T	133.8/147.2
IC802	1180001070	S.IC TA7805F (TE16L)	B	14.4/145.5
IC803	1180001070	S.IC TA7805F (TE16L)	B	15.7/129
IC805	1180000720	S.IC AN79L05M-(E1)	B	67.2/60.7
IC3001	1190001640	S.IC ISD4003-04MS	B	83.8/70.2
IC3002	1130008230	S.IC BU4053BCFV-E2	T	108/94.9
IC3003	1110003300	S.IC M5282FP 70CD	B	78.7/82.5
IC3004	1110000960	S.IC NJM4558M-TE1	B	92.1/81.7
IC3005	1130008230	S.IC BU4053BCFV-E2	T	85.3/80.2
IC3501	1140012371	S.IC HD64F2357F20 (SX-2178F-2)	T	154.2/84.1
IC3502	1110005770	S.IC S-80942CNMC-G9C-T2	T	150.9/136.3
IC3503	1130011330	S.IC CAT25C32SI	B	140.3/58.6
IC3504	1130007450	S.IC RTC-4553A	B	132.2/58.1
IC3551	1190000950	S.IC S1D13504F00A000 SED1354F0A	T	170/61
IC3552	1130007180	S.IC TC7WU04FU (TE12L)	T	182.5/72.7
IC3553	1130009360	S.IC LH61665AS-60A	T	177.2/36.7
IC3631	1130008230	S.IC BU4053BCFV-E2	T	131/90.6
IC3651	1120002770	S.IC TC74AC244FT (EL)	T	150.4/57.3
IC3652	1120002780	S.IC TC74AC245FT (EL)	T	148.9/48.3
IC3653	1120002790	S.IC TC74AC574FT (EL)	T	157.3/33.5
IC3654	1120002790	S.IC TC74AC574FT (EL)	T	148.9/40.8
IC3655	1120002880	S.IC TC74AC08FT (EL)	T	142/59.7
IC3656	1120002760	S.IC TC74AC32FT (EL)	T	139.8/54.2
IC3751	1110004310	S.IC M62352GP 75EC	T	78.4/24.1
IC3752	1130007570	S.IC BU4094BCFV-E2	T	135.2/73.2
IC3753	1130007570	S.IC BU4094BCFV-E2	T	135.2/81.5
IC3771	1130007110	S.IC TC7W04FU (TE12L)	T	158.7/127.2
Q131	1590002710	S.TR UMH11NTN	T	40.4/79
Q132	1590003280	S.TR UNR9211J-(TX)	T	37.3/81.8
Q141	1580000620	S.FET 3SK131-2T MAS	B	48.7/56
Q241	1560000560	S.FET 2SK882-GR (TE85L)	T	42.8/81.2
Q261	1560000560	S.FET 2SK882-GR (TE85L)	B	60.8/40.6
Q271	1560000560	S.FET 2SK882-GR (TE85L)	T	34.4/14.1
Q272	1560000560	S.FET 2SK882-GR (TE85L)	T	27.7/24.7
Q273	1560000560	S.FET 2SK882-GR (TE85L)	T	26/37.6
Q274	1530002060	S.TR 2SC4081 T106 R	T	33.6/48.4
Q275	1510000510	S.TR 2SA1576A T106R	T	33.6/44.1
Q276	1530002060	S.TR 2SC4081 T106 R	T	35.8/50.2
Q278	1590003430	S.TR UNR911HJ-(TX)	T	38.9/46.3
Q279	1530002060	S.TR 2SC4081 T106 R	T	27.1/51.5
Q331	1540000470	S.TR 2SD1801S-TL	B	100.2/145.4
Q333	1590002770	S.FET CPH3404-TL	B	84/146.4
Q334	1590003280	S.TR UNR9211J-(TX)	T	77/146.4
Q351	1590003280	S.TR UNR9211J-(TX)	T	10.6/111.3
Q471	1530002060	S.TR 2SC4081 T106 R	T	132.3/114.5
Q501	1590002710	S.TR UMH11NTN	T	90.1/41.2
Q502	1590002390	S.TR UMH4N TN	T	89.3/46.9
Q503	1530002060	S.TR 2SC4081 T106 R	T	81.1/30.5
Q504	1530002060	S.TR 2SC4081 T106 R	B	74.9/32.3
Q505	1510000510	S.TR 2SA1576A T106R	T	74.4/18.8
Q506	1590002150	S.TR DTC144EE TL	T	75.2/16.2
Q507	1590001870	S.TR DTA114EE TL	T	88.8/44.3
Q521	1510000510	S.TR 2SA1576A T106R	T	93.8/23.2
Q601	1540000440	S.TR 2SD1619-TD	T	90.4/13.9
Q602	1530002060	S.TR 2SC4081 T106 R	T	94.6/12
Q611	1540000440	S.TR 2SD1619-TD	T	90.5/7.9
Q612	1530002060	S.TR 2SC4081 T106 R	T	97.5/7
Q621	1510000920	S.TR 2SA1577 T106 Q	B	88.7/77.7
Q622	1590002710	S.TR UMH11NTN	T	87.7/10.6
Q631	1530002060	S.TR 2SC4081 T106 R	B	7.3/24
Q632	1530002060	S.TR 2SC4081 T106 R	B	4.8/31.5
Q651	1590001870	S.TR DTA114EE TL	B	4.5/35.2
Q652	1540000440	S.TR 2SD1619-TD	T	8.1/41.7
Q653	1590003280	S.TR UNR9211J-(TX)	T	22/4.7
Q691	1590003280	S.TR UNR9211J-(TX)	T	19.8/114.4
Q801	1530002060	S.TR 2SC4081 T106 R	T	86.7/16.9
Q803	1590002430	S.TR DTA144EE TL	T	86.2/13.1
Q804	1540000470	S.TR 2SD1801S-TL	B	29.1/130.9
Q3002	1590001870	S.TR DTA114EE TL	B	135.6/99.9
Q3504	1510000510	S.TR 2SA1576A T106R	T	128/58.3
Q3505	1590001940	S.TR DTC144EE TL	T	136.1/58.8
Q3551	1590001870	S.TR DTA114EE TL	B	175.1/65.2
Q3701	1590003280	S.TR UNR9211J-(TX)	T	138.5/49.1

M.=Mounted side (T: Mounted on the Top side, B: Mounted on the Bottom side)

[MAIN-A UNIT]

REF NO.	ORDER NO.	DESCRIPTION	M.	H/V LOCATION
Q3751	1590001960	S.TR XP4311 (TX)	T	112.3/76.5
Q3771	1510000510	S.TR 2SA1576A T106R	T	155.7/128.3
Q3772	1530002060	S.TR 2SC4081 T106 R	T	157.2/133.8
Q3773	1590003280	S.TR UNR9211J-(TX)	T	123.6/75.3
D111	1790001620	S.DIO 1SV308 (TPL3)	B	51.7/9.6
D112	1790001620	S.DIO 1SV308 (TPL3)	B	53.3/9.6
D113	1790001620	S.DIO 1SV308 (TPL3)	B	46.6/42.9
D114	1790001620	S.DIO 1SV308 (TPL3)	B	51/42.9
D115	1790000620	S.DIO MA77 (TX)	B	42.4/74.7
D116	1790000620	S.DIO MA77 (TX)	B	41.8/61.7
D117	1790000620	S.DIO MA77 (TX)	B	39/76.5
D118	1790000620	S.DIO MA77 (TX)	B	38.8/60.4
D251	1750000520	S.DIO DAN222TL	T	61.4/47.7
D252	1750000520	S.DIO DAN222TL	T	47.1/78.9
D271	1790001210	S.DIO 1SS375-TL	T	30.8/48.4
D273	1790001250	S.DIO MA2S111-(TX)	T	39/48
D351	1750000520	S.DIO DAN222TL	T	12.9/111.3
D501	1790001040	S.ZEN MA8033-L (TX)	B	79.9/26.5
D502	1790001250	S.DIO MA2S111-(TX)	B	83.7/29.8
D504	1790001240	S.DIO MA2S728-(TX)	B	82.1/44.5
D505	1790001040	S.ZEN MA8033-L (TX)	B	75.4/26.7
D531	1790001250	S.DIO MA2S111-(TX)	B	86.2/52
D532	1790001250	S.DIO MA2S111-(TX)	T	82.2/46.4
D533	1790001250	S.DIO MA2S111-(TX)	B	91.3/49.9
D541	1790001250	S.DIO MA2S111-(TX)	B	97/46.8
D542	1790001250	S.DIO MA2S111-(TX)	B	96.1/36.6
D561	1790001250	S.DIO MA2S111-(TX)	B	90.4/24.9
D571	1790001250	S.DIO MA2S111-(TX)	B	88.6/35.1
D601	1750000370	S.DIO DA221 TL	T	94.4/14.3
D611	1750000370	S.DIO DA221 TL	T	94.1/8.7
D631	1790001250	S.DIO MA2S111-(TX)	B	8.4/28.2
D632	1790001250	S.DIO MA2S111-(TX)	T	8.6/10.1
D691	1750000520	S.DIO DAN222TL	T	19.8/117.2
D801	1730002320	S.ZEN MA8031-M (TX)	B	2.5/131.4
D3001	1750000370	S.DIO DA221 TL	B	94.6/75
D3504	1790001250	S.DIO MA2S111-(TX)	T	131.8/53.7
D3505	1790001250	S.DIO MA2S111-(TX)	T	131.5/56.2
D3506	1790001250	S.DIO MA2S111-(TX)	T	131.5/58.7
D3507	1750000370	S.DIO DA221 TL	T	165.2/80.2
D3508	1790001670	S.DIO RB706F-40T106	T	136.9/87.7
D3509	1790001670	S.DIO RB706F-40T106	T	136.9/90.2
D3601	1790001250	S.DIO MA2S111-(TX)	B	146.3/95
D3602	1790001670	S.DIO RB706F-40T106	T	137.2/92.8
D3701	1750000520	S.DIO DAN222TL	T	140.7/46.7
D3702	1160000140	S.DIO DAP222 TL	T	140.6/49
D3750	1790001250	S.DIO MA2S111-(TX)	T	128.3/74.8
D3751	1790001250	S.DIO MA2S111-(TX)	T	129.2/66.3
D3752	1790001250	S.DIO MA2S111-(TX)	T	129.2/67.6
D3753	1790001250	S.DIO MA2S111-(TX)	T	129.2/68.9
D3754	1790001250	S.DIO MA2S111-(TX)	T	128.3/70.2
D3755	1790001250	S.DIO MA2S111-(TX)	T	130.8/71.3
D3756	1790001250	S.DIO MA2S111-(TX)	T	128.3/72.2
D3757	1790001250	S.DIO MA2S111-(TX)	T	128.3/73.5
D3758	1790001250	S.DIO MA2S111-(TX)	T	130.8/75.6
D3761	1790001250	S.DIO MA2S111-(TX)	T	128.5/79.3
D3762	1790001250	S.DIO MA2S111-(TX)	T	128.5/80.6
D3763	1790001250	S.DIO MA2S111-(TX)	T	128.5/81.9
D3771	1750000520	S.DIO DAN222TL	T	154.9/133.5
FI111	2020000260	CER CFK455E10	T	55.2/66.5
FI131	2020001740	CER CFWLB455KJFA-B0	T	45/66.3
FI133	2020001510	CER CFWLA455KJFA-B0	T	32.4/66.8
X3501	6050009520	S.XTL CR-520 (19.6608 MHz+)	T	139.7/100.4
X3551	6060000740	S.CER CSTCV26M0X51J-R0	T	183.1/67.5
L111	6150004080	COL LS-468 (C-13958)	T	52.4/15.5
L112	6150004080	COL LS-468 (C-13958)	T	45.3/32.9
L113	6150004080	COL LS-468 (C-13958)	T	52.3/48.9
L114	6200005490	S.COL NL 322522T-331J	T	52.6/9.5
L115	6200005490	S.COL NL 322522T-331J	B	56.4/11.9
L141	6150004080	COL LS-468 (C-13958)	T	45.2/60.6
L151	6200003260	S.COL NL 322522T-101J	T	56.7/93.5
L152	6200003260	S.COL NL 322522T-101J	T	41.1/96.3
L201	6200003950	S.COL HF50ACC 322513-T	T	60.2/61.3
L202	6200003950	S.COL HF50ACC 322513-T	T	59/69
L203	6200003950	S.COL HF50ACC 322513-T	T	59/77
L204	6200003950	S.COL HF50ACC 322513-T	T	58.2/112.1
L205	6200003950	S.COL HF50ACC 322513-T	T	132/133.4
L206	6200003950	S.COL HF50ACC 322513-T	T	143.9/143.8
L221	6200003260	S.COL NL 322522T-101J	T	37/96.3
L227	6200003260	S.COL NL 322522T-101J	B	30.6/79.8
L241	6200003520	S.COL ELJFB 102K-F	T	47.3/78.4
L261	6150004090	COL LS-469 (C-13969)	T	57.9/32.8
L271	6150002291	COL LS-450	T	25.8/17
L272	6150002291	COL LS-450	T	23.9/29.9

S.=Surface mount

[MAIN-A UNIT]

REF NO.	ORDER NO.	DESCRIPTION	M.	H/V LOCATION
L273	6150002291	COL LS-450	T	31.4/43.3
L274	6180001000	COL LAL 04NA 102K	T	39.5/52.2
L351	6910003570	COL 2943-666663	T	19.3/92.8
L352	6910003570	COL 2943-666663	T	26.9/98.7
L353	6200003950	S.COL HF50ACC 322513-T	B	11.6/97.9
L354	6200003950	S.COL HF50ACC 322513-T	B	6.3/101.1
L451	6200001830	S.COL NL 322522T-100J	B	137.5/130.5
L452	6180002650	COL RCR-875D-472K	T	113.4/115.5
L631	6200003950	S.COL HF50ACC 322513-T	B	30.3/90.7
L641	6200003240	S.COL NL 322522T-221J	B	27.2/91.5
L642	6200003240	S.COL NL 322522T-221J	B	23.7/91.2
L643	6200008820	S.COL HF70ACC 635050-T	T	25.4/106.5
L644	6200008820	S.COL HF70ACC 635050-T	T	26/86.8
L658	6200003950	S.COL HF50ACC 322513-T	B	11.5/47.9
L659	6200003950	S.COL HF50ACC 322513-T	B	8.4/18.7
L661	6200003260	S.COL NL 322522T-101J	B	17.7/24.4
L662	6200003260	S.COL NL 322522T-101J	B	17.8/16.8
L663	6200003950	S.COL HF50ACC 322513-T	T	10/32.5
L664	6200003260	S.COL NL 322522T-101J	B	20/21.3
L665	6200003260	S.COL NL 322522T-101J	T	13/5.1
L666	6200003950	S.COL HF50ACC 322513-T	B	20.2/27.7
L667	6200003260	S.COL NL 322522T-101J	T	18.8/5.1
L668	6200003260	S.COL NL 322522T-101J	B	15.5/42.5
L669	6200003950	S.COL HF50ACC 322513-T	T	13.7/32.9
L670	6200003260	S.COL NL 322522T-101J	B	19.5/38.5
L681	6200003260	S.COL NL 322522T-101J	B	30.1/172.9
L691	6200003950	S.COL HF50ACC 322513-T	B	2.6/139.7
L692	6200003950	S.COL HF50ACC 322513-T	B	8.8/138
L701	2040000490	COL EXC-ELDR25C	T	130/29.5
L702	6200003950	S.COL HF50ACC 322513-T	B	124/39.1
L703	6200003950	S.COL HF50ACC 322513-T	B	123.3/35.7
L704	6200003260	S.COL NL 322522T-101J	B	121.8/32.7
L705	6200003260	S.COL NL 322522T-101J	B	123.3/29.7
L706	6200003260	S.COL NL 322522T-101J	B	124.8/26.7
L707	6200003260	S.COL NL 322522T-101J	T	132.7/32.8
L708	6200003260	S.COL NL 322522T-101J	B	39.4/14.4
L709	6200003950	S.COL HF50ACC 322513-T	B	51/143.4
L710	2040000490	COL EXC-ELDR25C	T	30.8/137.4
L711	6200003950	S.COL HF50ACC 322513-T	B	57.2/143.4
L712	6200003950	S.COL HF50ACC 322513-T	B	27.6/140.6
L713	6200003260	S.COL NL 322522T-101J	B	26.2/148
L714	6200003260	S.COL NL 322522T-101J	B	22.3/147.2
L715	6200003260	S.COL NL 322522T-101J	B	19.3/148.6
L716	6200003950	S.COL HF50ACC 322513-T	T	21.3/134.9
L717	6200003950	S.COL HF50ACC 322513-T	B	31.2/147.5
L719	2040000490	COL EXC-ELDR25C	T	54.8/6.2
L720	6180003040	COL LHL 08NB 101K	T	64.2/18.6
L721	6200003220	S.COL NL 322522T-151J	B	73/5.6
L722	2040000490	COL EXC-ELDR25C	T	20.3/78
L723	2040000490	COL EXC-ELDR25C	T	19/74.9
L3001	6200001830	S.COL NL 322522T-100J	T	84.4/66
L3002	6200003260	S.COL NL 322522T-101J	T	83.7/62.3
L3501	6200003950	S.COL HF50ACC 322513-T	B	172.8/71.6
L3601	6200003950	S.COL HF50ACC 322513-T	T	120.8/137.1
L3602	6200003950	S.COL HF50ACC 322513-T	T	103.5/113
L3603	6180002650	COL RCR-875D-472K	T	99.6/59.3
L3604	6180002650	COL RCR-875D-472K	T	178.3/4.7
R102	7030003730	S.RES ERJ3GEYJ 274 V (270 kΩ)	T	86.1/20.4
R103	7030003680	S.RES ERJ3GEYJ 104 V (100 kΩ)	T	88/21.2
R104	7030003620	S.RES ERJ3GEYJ 333 V (33 kΩ)	T	91/21.5
R105	7030003680	S.RES ERJ3GEYJ 104 V (100 kΩ)	T	90.2/19.6
R106	7030003680	S.RES ERJ3GEYJ 104 V (100 kΩ)	T	89.5/32.3
R107	7030003680	S.RES ERJ3GEYJ 104 V (100 kΩ)	T	86.8/32.3
R108	7030003400	S.RES ERJ3GEYJ 471 V (470 Ω)	B	74.9/30.1
R111	7030003680	S.RES ERJ3GEYJ 104 V (100 kΩ)	T	45.7/25.8
R112	7030003400	S.RES ERJ3GEYJ 471 V (470 Ω)	T	47.1/43.5
R113	7030003440	S.RES ERJ3GEYJ 102 V (1 kΩ)	T	48.8/43.6
R115	7030000310	S.RES MCR10EZHU 270 Ω (271)	T	45.6/38.5
R116	7030003440	S.RES ERJ3GEYJ 102 V (1 kΩ)	B	57.1/29.7
R118	7030000340	S.RES MCR10EZHU 470 Ω (471)	B	55.4/8.9
R119	7030003560	S.RES ERJ3GEYJ 103 V (10 kΩ)	B	38/58
R120	7030003560	S.RES ERJ3GEYJ 103 V (10 kΩ)	B	40.3/63.6
R125	7030003560	S.RES ERJ3GEYJ 103 V (10 kΩ)	T	43.4/76
R126	7030003560	S.RES ERJ3GEYJ 103 V (10 kΩ)	B	39/78.6
R127	7030003560	S.RES ERJ3GEYJ 103 V (10 kΩ)	B	38/63.5
R130	7030003560	S.RES ERJ3GEYJ 103 V (10 kΩ)	T	35.5/77.8
R134	7030003560	S.RES ERJ3GEYJ 103 V (10 kΩ)	T	40.5/81.8
R135	7030003440	S.RES ERJ3GEYJ 102 V (1 kΩ)	T	33.6/58.2
R136	7030003440	S.RES ERJ3GEYJ 102 V (1 kΩ)	T	39.1/81.8
R141	7030003560	S.RES ERJ3GEYJ 103 V (10 kΩ)	B	55.1/48.2
R142	7030003280	S.RES ERJ3GEYJ 470 V (47 Ω)	B	48/52.7
R143	7030003460	S.RES ERJ3GEYJ 152 V (1.5 kΩ)	B	52.9/53
R144	7030003300	S.RES ERJ3GEYJ 680 V (68 Ω)	B	52.4/56.8
R145	7030003460	S.RES ERJ3GEYJ 152 V (1.5 kΩ)	B	48.7/59.4
R146	7030003200	S.RES ERJ3GEYJ 100 V (10 Ω)	T	47.5/55.6
R147	7030003460	S.RES ERJ3GEYJ 152 V (1.5 kΩ)	T	54.6/54.6
R148	7030003560	S.RES ERJ3GEYJ 103 V (10 kΩ)	T	50.5/55.6
R151	7030003460	S.RES ERJ3GEYJ 152 V (1.5 kΩ)	B	44.6/94.3
R152	7030003560	S.RES ERJ3GEYJ 103 V (10 kΩ)	T	50.8/99.9
R153	7030003800	S.RES ERJ3GEYJ 105 V (1 MΩ)	B	51.5/96.9
R154	7030003640	S.RES ERJ3GEYJ 473 V (47 kΩ)	T	46/97.1

M.=Mounted side (T: Mounted on the Top side, B: Mounted on the Bottom side)

[MAIN-A UNIT]

REF NO.	ORDER NO.	DESCRIPTION	M.	H/V LOCATION
R201	7030003200	S.RES ERJ3GEYJ 100 V (10 Ω)	T	30.7/110.5
R202	7030008061	S.RES ERA3YED 222V	T	37/118.1
R203	7030003200	S.RES ERJ3GEYJ 100 V (10 Ω)	B	37.1/108.6
R205	7030008061	S.RES ERA3YED 222V	T	40.4/116.1
R206	7030003640	S.RES ERJ3GEYJ 473 V (47 kΩ)	T	35.9/102.3
R207	7030006461	S.RES ERA3YED 152V	T	33.3/102.3
R208	7030006461	S.RES ERA3YED 152V	T	33.3/104.7
R209	7030006461	S.RES ERA3YED 152V	T	36.7/107.3
R210	7310002690	S.TRI RV-145 (RH03A3A13X0CA) 102	T	46.3/108.8
R213	7030003320	S.RES ERJ3GEYJ 101 V (100 Ω)	B	42.7/96.9
R214	7510001580	S.TMR NTCG16 4BH 153KT	T	35.7/119.4
R221	7030003440	S.RES ERJ3GEYJ 102 V (1 kΩ)	T	40.1/93.3
R222	7030003420	S.RES ERJ3GEYJ 681 V (680 Ω)	T	39.8/84.3
R223	7030003510	S.RES ERJ3GEYJ 392 V (3.9 kΩ)	T	40.9/90.1
R224	7030003360	S.RES ERJ3GEYJ 221 V (220 Ω)	T	35.9/85.1
R225	7030003530	S.RES ERJ3GEYJ 562 V (5.6 kΩ)	T	38.5/84.4
R226	7030003440	S.RES ERJ3GEYJ 102 V (1 kΩ)	T	37.2/84.4
R227	7030003440	S.RES ERJ3GEYJ 102 V (1 kΩ)	T	34.2/81.2
R229	7030003530	S.RES ERJ3GEYJ 562 V (5.6 kΩ)	B	35/92.2
R230	7030003520	S.RES ERJ3GEYJ 472 V (4.7 kΩ)	B	35.8/89.8
R231	7030003500	S.RES ERJ3GEYJ 332 V (3.3 kΩ)	B	38.3/87.7
R232	7030003500	S.RES ERJ3GEYJ 332 V (3.3 kΩ)	B	38.6/83.5
R241	7030009691	S.RES ERA3YED 101V (100 Ω)	B	42.4/80.4
R242	7030003550	S.RES ERJ3GEYJ 822 V (8.2 kΩ)	T	48.5/86
R243	7510001670	S.TMR NTCG16 4BH 103KT	T	49.8/86
R244	7030005681	S.RES ERA3YKD 473V (47 kΩ)	B	46/81.1
R246	7030005981	S.RES ERA3YED 333V	T	47/84.9
R247	7310002600	S.TRI RV-110 (RH03A3AS4X0AA) 473	T	59.5/50.1
R248	7030003320	S.RES ERJ3GEYJ 101 V (100 Ω)	T	66.8/46.5
R249	7030003680	S.RES ERJ3GEYJ 104 V (100 kΩ)	T	42.4/86.1
R250	7030003440	S.RES ERJ3GEYJ 102 V (1 kΩ)	T	44.4/86.3
R251	7030003460	S.RES ERJ3GEYJ 152 V (1.5 kΩ)	T	45.8/82.1
R253	7030003470	S.RES ERJ3GEYJ 282 V (1.8 kΩ)	B	42.8/77.2
R261	7030003490	S.RES ERJ3GEYJ 172 V (2.7 kΩ)	B	61.6/43.3
R262	7030003440	S.RES ERJ3GEYJ 102 V (1 kΩ)	T	66.4/41.5
R263	7310002760	S.TRI RV-152 (RH03A3AJ4X0HA) 223	T	63.6/39.5
R264	7030003320	S.RES ERJ3GEYJ 101 V (100 Ω)	T	62.6/43.4
R265	7030003400	S.RES ERJ3GEYJ 471 V (470 Ω)	B	63/41.8
R271	7310002760	S.TRI RV-152 (RH03A3AJ4X0HA) 223	T	40.1/19.5
R272	7030003400	S.RES ERJ3GEYJ 471 V (470 Ω)	T	35.7/17.2
R273	7030003320	S.RES ERJ3GEYJ 101 V (100 Ω)	B	34.9/15.3
R274	7030003600	S.RES ERJ3GEYJ 223 V (22 kΩ)	T	26/22.8
R275	7030003400	S.RES ERJ3GEYJ 471 V (470 Ω)	T	30.6/24.7
R276	7030003320	S.RES ERJ3GEYJ 101 V (100 Ω)	B	31.9/27.7
R277	7030003600	S.RES ERJ3GEYJ 223 V (22 kΩ)	T	24.3/35.7
R279	7030003520	S.RES ERJ3GEYJ 472 V (4.7 kΩ)	B	27.9/43.3
R280	7030003320	S.RES ERJ3GEYJ 101 V (100 Ω)	T	29.3/37.5
R281	7030003680	S.RES ERJ3GEYJ 104 V (100 kΩ)	B	33.1/51.9
R283	7030003640	S.RES ERJ3GEYJ 473 V (47 kΩ)	B	35.9/50
R284	7030003640	S.RES ERJ3GEYJ 473 V (47 kΩ)	T	35.5/46.4
R285	7030003840	S.RES ERJ3GEYJ 225 V (2.2 MΩ)	T	33.6/46.3
R286	7030003380	S.RES ERJ3GEYJ 331 V (3.3 MΩ)	B	34.6/26.1
R287	7030003540	S.RES ERJ3GEYJ 682 V (6.8 kΩ)	B	35.5/46.1
R290	7030003540	S.RES ERJ3GEYJ 682 V (6.8 kΩ)	T	38.6/49.3
R292	7030003600	S.RES ERJ3GEYJ 223 V (22 kΩ)	T	27.3/49.6
R293	7030003600	S.RES ERJ3GEYJ 223 V (22 kΩ)	T	24.5/49.2
R294	7030003440	S.RES ERJ3GEYJ 102 V (1 kΩ)	T	27.2/53.4
R301	7030003440	S.RES ERJ3GEYJ 102 V (1 kΩ)	T	96.1/109
R302	7030003440	S.RES ERJ3GEYJ 102 V (1 kΩ)	T	83.9/92.4
R303	7030003440	S.RES ERJ3GEYJ 102 V (1 kΩ)	B	93.4/100.9
R304	7030003560	S.RES ERJ3GEYJ 103 V (10 kΩ)	B	89/103.5
R305	7030003400	S.RES ERJ3GEYJ 471 V (470 Ω)	T	93.4/114
R306	7030003400	S.RES ERJ3GEYJ 471 V (470 Ω)	T	98.5/109.3
R307	7030003560	S.RES ERJ3GEYJ 103 V (10 kΩ)	T	99/119.8
R311	7030003640	S.RES ERJ3GEYJ 473 V (47 kΩ)	B	88.3/107.5
R312	7030003560	S.RES ERJ3GEYJ 103 V (10 kΩ)	B	85.6/103.5
R313	7030003440	S.RES ERJ3GEYJ 102 V (1 kΩ)	B	89/99.9
R314	7030003520	S.RES ERJ3GEYJ 472 V (4.7 kΩ)	T	69.8/109.9
R315	7030003640	S.RES ERJ3GEYJ 473 V (47 kΩ)	T	63/113.8
R316	7030003200	S.RES ERJ3GEYJ 100 V (10 Ω)	T	87.8/108.9
R317	7030003670	S.RES ERJ3GEYJ 823 V (82 kΩ)	B	88.6/110.9
R318	7030003730	S.RES ERJ3GEYJ 274 V (270 kΩ)	T	79.4/114.8
R320	7030003680	S.RES ERJ3GEYJ 104 V (100 kΩ)	T	93.5/108.5
R321	7030003520	S.RES ERJ3GEYJ 472 V (4.7 kΩ)	B	95.2/100.9
R322	7030003690	S.RES ERJ3GEYJ 124 V (120 kΩ)	T	104.6/77.7
R323	7030003690	S.RES ERJ3GEYJ 124 V (120 kΩ)	T	106.4/79.7
R324	7030003690	S.RES ERJ3GEYJ 124 V (120 kΩ)	T	105.4/75.8
R325	7030003440	S.RES ERJ3GEYJ 102 V (1 kΩ)	T	83.9/95
R331	7030003400	S.RES ERJ3GEYJ 471 V (470 Ω)	T	75.6/138.3
R332	7030003400	S.RES ERJ3GEYJ 471 V (470 Ω)	T	83.8/132.3
R333	7030003520	S.RES ERJ3GEYJ 472 V (4.7 kΩ)	T	81.8/139.4
R334	7030003440	S.RES ERJ3GEYJ 102 V (1 kΩ)	B	91/144.9
R335	7030003400	S.RES ERJ3GEYJ 471 V (470 Ω)	T	86.7/145.5
R336	7030003280	S.RES ERJ3GEYJ 470 V (47 Ω)	B	94.3/143.6
R337	7030003560	S.RES ERJ3GEYJ 103 V (10 kΩ)	T	85.5/140.1
R338	7030003680	S.RES ERJ3GEYJ 104 V (100 kΩ)	T	104.1/82.5
R339	7030003680	S.RES ERJ3GEYJ 104 V (100 kΩ)	T	100.3/82.7
R340	7030003440			

[MAIN-A UNIT]

REF NO.	ORDER NO.	DESCRIPTION	M.	H/V LOCATION
R362	7030003400	S.RES ERJ3GEYJ 471 V (470 Ω)	B	88.9/97
R363	7030003560	S.RES ERJ3GEYJ 103 V (10 kΩ)	T	94.2/94.6
R364	7030003630	S.RES ERJ3GEYJ 393 V (39 kΩ)	B	93.4/93.8
R365	7030003640	S.RES ERJ3GEYJ 473 V (47 kΩ)	B	60.5/102.3
R366	7030003520	S.RES ERJ3GEYJ 472 V (4.7 kΩ)	T	62.2/101.4
R367	7030003460	S.RES ERJ3GEYJ 152 V (1.5 kΩ)	T	62.2/100.1
R369	7030003440	S.RES ERJ3GEYJ 102 V (1 kΩ)	B	60.5/98.8
R370	7030003320	S.RES ERJ3GEYJ 101 V (100 Ω)	T	60.9/112.2
R371	7030003760	S.RES ERJ3GEYJ 474 V (470 kΩ)	B	81/95.8
R372	7030003640	S.RES ERJ3GEYJ 473 V (47 kΩ)	B	78.4/96
R373	7030003480	S.RES ERJ3GEYJ 222 V (2.2 kΩ)	B	75/96
R374	7030003680	S.RES ERJ3GEYJ 104 V (100 kΩ)	B	75/92.4
R375	7030003520	S.RES ERJ3GEYJ 472 V (4.7 kΩ)	T	71.9/96
R376	7030009930	S.RES ERJ3GEYJ 825 V (8.2 MΩ)	B	66/108
R377	7030003520	S.RES ERJ3GEYJ 472 V (4.7 kΩ)	B	72.3/104
R378	7030003320	S.RES ERJ3GEYJ 101 V (100 Ω)	T	86.5/108.9
R379	7030003670	S.RES ERJ3GEYJ 823 V (82 kΩ)	T	68.2/106.9
R380	7030003730	S.RES ERJ3GEYJ 274 V (270 kΩ)	T	69.8/108.5
R381	7030003560	S.RES ERJ3GEYJ 103 V (10 kΩ)	T	69.4/102.2
R390	7030003400	S.RES ERJ3GEYJ 471 V (470 Ω)	T	100.1/84.6
R391	7030003400	S.RES ERJ3GEYJ 471 V (470 Ω)	T	108/84
R392	7310002580	S.TRI RV-108 (RH03A3A15X05A) 104	T	78.3/49
R393	7030003640	S.RES ERJ3GEYJ 473 V (47 kΩ)	T	83/51.8
R394	7030003680	S.RES ERJ3GEYJ 104 V (100 kΩ)	T	83/50.5
R395	7030003680	S.RES ERJ3GEYJ 104 V (100 kΩ)	T	119.8/95.7
R451	7030003560	S.RES ERJ3GEYJ 103 V (10 kΩ)	T	118.2/123.3
R453	7030003520	S.RES ERJ3GEYJ 472 V (4.7 kΩ)	T	134.9/124.4
R454	7030003710	S.RES ERJ3GEYJ 184 V (180 kΩ)	B	126.4/124.4
R455	7030003730	S.RES ERJ3GEYJ 274 V (270 kΩ)	B	131.5/124.4
R456	7030003550	S.RES ERJ3GEYJ 822 V (8.2 kΩ)	B	128.1/126.2
R457	7030003510	S.RES ERJ3GEYJ 392 V (3.9 kΩ)	T	126.4/126.8
R458	7030003540	S.RES ERJ3GEYJ 682 V (6.8 kΩ)	B	121.6/112.4
R459	7030003720	S.RES ERJ3GEYJ 224 V (220 kΩ)	B	121.8/119.8
R460	7030003680	S.RES ERJ3GEYJ 104 V (100 kΩ)	B	124.7/124.4
R461	7030003600	S.RES ERJ3GEYJ 223 V (22 kΩ)	B	124.7/126.2
R462	7030003560	S.RES ERJ3GEYJ 103 V (10 kΩ)	B	128.1/124.4
R463	7030003560	S.RES ERJ3GEYJ 103 V (10 kΩ)	B	130.9/112.6
R464	7030003640	S.RES ERJ3GEYJ 473 V (47 kΩ)	B	131.4/110.7
R465	7030003640	S.RES ERJ3GEYJ 473 V (47 kΩ)	B	124.4/110.6
R466	7030003680	S.RES ERJ3GEYJ 104 V (100 kΩ)	B	124.6/112.7
R471	7030003440	S.RES ERJ3GEYJ 102 V (1 kΩ)	B	127.5/111.8
R472	7030003520	S.RES ERJ3GEYJ 472 V (4.7 kΩ)	T	131.6/111.5
R473	7030005451	S.RES ERA3YED 153V	T	134.8/114.9
R474	7030003390	S.RES ERJ3GEYJ 391 V (390 Ω)	T	134/111.5
R475	7030003680	S.RES ERJ3GEYJ 104 V (100 kΩ)	T	98.1/65.3
R476	7030003320	S.RES ERJ3GEYJ 101 V (100 Ω)	T	125.2/115.4
R477	7030003550	S.RES ERJ3GEYJ 822 V (8.2 kΩ)	T	132.7/123.7
R478	7030003680	S.RES ERJ3GEYJ 104 V (100 kΩ)	T	130.8/125.1
R479	7030003420	S.RES ERJ3GEYJ 681 V (680 Ω)	T	124.9/114.1
R480	7030005451	S.RES ERA3YED 153V	T	134.8/113.6
R501	7030008180	S.RES ERJ12YJ331U (330 Ω)	B	85.5/26.1
R502	7030003380	S.RES ERJ3GEYJ 331 V (330 Ω)	B	79.3/43.1
R503	7030003600	S.RES ERJ3GEYJ 223 V (22 kΩ)	B	85.5/29.8
R504	7030003620	S.RES ERJ3GEYJ 333 V (33 kΩ)	B	86/36.8
R505	7030003720	S.RES ERJ3GEYJ 224 V (220 kΩ)	B	88.8/36.8
R507	7310002800	S.TRI RV-156 (RH03A3AJ5) 224	T	85.3/39.8
R509	7310002800	S.TRI RV-156 (RH03A3AJ5) 224	T	85.3/43.3
R510	7310002580	S.TRI RV-108 (RH03A3A15X05A) 104	T	85.3/46.8
R511	7030003720	S.RES ERJ3GEYJ 224 V (220 kΩ)	B	89.6/38.6
R512	7030009920	S.RES ERJ3GEYJ 335 V (3.3 MΩ)	B	83.8/39.8
R513	7030003380	S.RES ERJ3GEYJ 331 V (330 Ω)	B	84.3/42.4
R514	7030003640	S.RES ERJ3GEYJ 473 V (47 kΩ)	B	85.7/27.4
R515	7030003760	S.RES ERJ3GEYJ 474 V (470 kΩ)	B	85.3/33.3
R516	7030003600	S.RES ERJ3GEYJ 223 V (22 kΩ)	T	76.3/18.9
R517	7030003760	S.RES ERJ3GEYJ 473 V (470 kΩ)	B	71.1/18
R518	7030003680	S.RES ERJ3GEYJ 104 V (100 kΩ)	T	84.1/22.8
R521	7030003560	S.RES ERJ3GEYJ 103 V (10 kΩ)	T	95.8/23.3
R522	7030003680	S.RES ERJ3GEYJ 104 V (100 kΩ)	T	95.8/26
R531	7030003680	S.RES ERJ3GEYJ 104 V (100 kΩ)	B	83.7/52.8
R532	7030003560	S.RES ERJ3GEYJ 103 V (10 kΩ)	B	83.7/49.4
R533	7030003720	S.RES ERJ3GEYJ 224 V (220 kΩ)	B	85.5/49.4
R534	7030003660	S.RES ERJ3GEYJ 683 V (68 kΩ)	T	90.5/49.8
R535	7030003500	S.RES ERJ3GEYJ 332 V (3.3 kΩ)	T	93.2/49.9
R536	7030003400	S.RES ERJ3GEYJ 471 V (470 Ω)	B	88.1/49.8
R537	7510001420	S.TMR NTCG20 3SH 223JT	T	87.5/49.4
R541	7030003640	S.RES ERJ3GEYJ 473 V (47 kΩ)	T	93.8/48.6
R542	7030003640	S.RES ERJ3GEYJ 473 V (47 kΩ)	B	94.6/49.8
R543	7030003620	S.RES ERJ3GEYJ 333 V (33 kΩ)	T	96.4/43.5
R544	7030003620	S.RES ERJ3GEYJ 333 V (33 kΩ)	T	91.6/46.9
R545	7310002740	S.TRI RV-150 (RH03A3A14X0FC) 103	T	94/45.5
R546	7030003800	S.RES ERJ3GEYJ 105 V (1 MΩ)	T	96.4/46.9
R551	7030009920	S.RES ERJ3GEYJ 335 V (3.3 MΩ)	B	97/43.5
R552	7030009930	S.RES ERJ3GEYJ 825 V (8.2 MΩ)	B	94.3/39.5
R553	7030003840	S.RES ERJ3GEYJ 225 V (2.2 MΩ)	T	92/41
R561	7030003360	S.RES ERJ3GEYJ 221 V (220 Ω)	B	92.7/24.2
R562	7030003760	S.RES ERJ3GEYJ 474 V (470 kΩ)	B	93/27.2
R563	7030003680	S.RES ERJ3GEYJ 104 V (100 kΩ)	B	96.1/26.8
R564	7030003560	S.RES ERJ3GEYJ 103 V (10 kΩ)	B	96.1/25.5
R571	7030003360	S.RES ERJ3GEYJ 221 V (220 Ω)	B	87.7/32.8
R574	7030003600	S.RES ERJ3GEYJ 223 V (22 kΩ)	B	87.3/29.8
R601	7030006210	S.RES ERJ12YJ4R7U (4.7 Ω)	B	93.3/13
R602	7030003440	S.RES ERJ3GEYJ 102 V (1 kΩ)	T	96.6/14.3
R603	7030003560	S.RES ERJ3GEYJ 103 V (10 kΩ)	T	97.4/11.9

M.=Mounted side (T: Mounted on the Top side, B: Mounted on the Bottom side)

[MAIN-A UNIT]

REF NO.	ORDER NO.	DESCRIPTION	M.	H/V LOCATION
R611	7030006210	S.RES ERJ12YJ4R7U (4.7 Ω)	B	93.3/8.6
R612	7030003440	S.RES ERJ3GEYJ 102 V (1 kΩ)	T	95.8/8.9
R613	7030003560	S.RES ERJ3GEYJ 103 V (10 kΩ)	T	100.2/6.4
R621	7030003640	S.RES ERJ3GEYJ 473 V (47 kΩ)	B	86.3/7.2
R622	7030003460	S.RES ERJ3GEYJ 152 V (1.5 kΩ)	B	88.6/12.6
R623	7030003560	S.RES ERJ3GEYJ 103 V (10 kΩ)	B	88.3/10
R631	7030003520	S.RES ERJ3GEYJ 472 V (4.7 kΩ)	B	9/31.5
R632	7030003620	S.RES ERJ3GEYJ 333 V (33 kΩ)	B	8.8/26.4
R633	7030003580	S.RES ERJ3GEYJ 153 V (15 kΩ)	B	10/23.3
R634	7030003520	S.RES ERJ3GEYJ 472 V (4.7 kΩ)	B	3.8/25.2
R635	7030003520	S.RES ERJ3GEYJ 472 V (4.7 kΩ)	B	10.8/31.5
R636	7030003620	S.RES ERJ3GEYJ 333 V (33 kΩ)	B	12.6/31.5
R637	7030003580	S.RES ERJ3GEYJ 153 V (15 kΩ)	B	14.4/31.5
R638	7030003520	S.RES ERJ3GEYJ 472 V (4.7 kΩ)	B	4.3/27
R651	7030003380	S.RES ERJ3GEYJ 331 V (330 Ω)	B	8.7/34.2
R652	7030003560	S.RES ERJ3GEYJ 103 V (10 kΩ)	B	8.7/35.8
R653	7030003550	S.RES ERJ3GEYJ 822 V (8.2 kΩ)	T	22.2/6.4
R691	7030003200	S.RES ERJ3GEYJ 100 V (10 Ω)	T	21.5/114.4
R761	7030003360	S.RES ERJ3GEYJ 221 V (220 Ω)	T	128.6/19.3
R762	7030003360	S.RES ERJ3GEYJ 221 V (220 Ω)	T	129.4/18
R763	7030003360	S.RES ERJ3GEYJ 221 V (220 Ω)	B	126.8/19.7
R801	7030003560	S.RES ERJ3GEYJ 103 V (10 kΩ)	B	86/13.4
R802	7030003280	S.RES ERJ3GEYJ 470 V (47 Ω)	B	35.5/129.9
R803	7030003480	S.RES ERJ3GEYJ 222 V (2.2 kΩ)	T	89.2/17.1
R804	7030000340	S.RES MCR10EZJH 470 Ω (471)	B	19.2/122.4
R806	7030003440	S.RES ERJ3GEYJ 102 V (1 kΩ)	B	134.9/128
R807	7030003360	S.RES ERJ3GEYJ 221 V (220 Ω)	B	133.3/129.8
R3003	7030003640	S.RES ERJ3GEYJ 473 V (47 kΩ)	T	76.6/74.8
R3004	7030003640	S.RES ERJ3GEYJ 473 V (47 kΩ)	B	75.8/62.3
R3005	7030003440	S.RES ERJ3GEYJ 102 V (1 kΩ)	T	108.7/99.4
R3006	7030003400	S.RES ERJ3GEYJ 471 V (470 Ω)	T	102.2/93.4
R3007	7030003400	S.RES ERJ3GEYJ 471 V (470 Ω)	T	104.6/99.7
R3010	7030003600	S.RES ERJ3GEYJ 223 V (22 kΩ)	B	72.2/90.8
R3011	7030003670	S.RES ERJ3GEYJ 823 V (82 kΩ)	B	79.5/89
R3012	7030003730	S.RES ERJ3GEYJ 274 V (270 kΩ)	B	76.8/90.4
R3013	7030003560	S.RES ERJ3GEYJ 103 V (10 kΩ)	B	84.2/79.6
R3015	7030003690	S.RES ERJ3GEYJ 124 V (120 kΩ)	B	94/76.9
R3016	7030003680	S.RES ERJ3GEYJ 104 V (100 kΩ)	B	82.8/85.4
R3017	7030003480	S.RES ERJ3GEYJ 222 V (2.2 kΩ)	B	94.3/72
R3018	7030003640	S.RES ERJ3GEYJ 473 V (47 kΩ)	B	96.1/72
R3019	7030003360	S.RES ERJ3GEYJ 221 V (220 Ω)	B	94.4/87.9
R3020	7030003640	S.RES ERJ3GEYJ 473 V (47 kΩ)	T	80.8/81.1
R3021	7030003360	S.RES ERJ3GEYJ 221 V (220 Ω)	T	91.4/81.4
R3022	7030003400	S.RES ERJ3GEYJ 471 V (470 Ω)	B	87.3/78.8
R3023	7030003400	S.RES ERJ3GEYJ 471 V (470 Ω)	T	91.3/82.8
R3024	7030003680	S.RES ERJ3GEYJ 104 V (100 kΩ)	B	85.4/81.4
R3025	7030003560	S.RES ERJ3GEYJ 103 V (10 kΩ)	T	98.5/85.9
R3026	7030003820	S.RES ERJ3GEYJ 155 V (1.5 MΩ)	B	91.9/86.9
R3027	7030003670	S.RES ERJ3GEYJ 823 V (82 kΩ)	B	91.9/89.5
R3028	7030003670	S.RES ERJ3GEYJ 823 V (82 kΩ)	B	88.1/87.5
R3030	7030003680	S.RES ERJ3GEYJ 104 V (100 kΩ)	T	102.2/94.7
R3032	7030003680	S.RES ERJ3GEYJ 104 V (100 kΩ)	B	84.8/86.2
R3033	7030003680	S.RES ERJ3GEYJ 104 V (100 kΩ)	T	78.1/84
R3034	7030003450	S.RES ERJ3GEYJ 122 V (1.2 kΩ)	T	78.1/81.1
R3035	7030003440	S.RES ERJ3GEYJ 102 V (1 kΩ)	B	74.7/84.8
R3036	7030003320	S.RES ERJ3GEYJ 101 V (100 Ω)	B	88/90.3
R3037	7030003560	S.RES ERJ3GEYJ 103 V (10 kΩ)	T	73.8/73.1
R3040	7030003640	S.RES ERJ3GEYJ 473 V (47 kΩ)	B	80/59.7
R3041	7030003640	S.RES ERJ3GEYJ 473 V (47 kΩ)	B	80.8/62.3
R3042	7030003480	S.RES ERJ3GEYJ 222 V (2.2 kΩ)	B	96.7/77.9
R3501	7030003640	S.RES ERJ3GEYJ 473 V (47 kΩ)	B	152.1/71.6
R3502	7030003640	S.RES ERJ3GEYJ 473 V (47 kΩ)	B	142.6/98.7
R3503	7030003640	S.RES ERJ3GEYJ 473 V (47 kΩ)	T	168.4/84.9
R3505	7030003620	S.RES ERJ3GEYJ 333 V (33 kΩ)	T	144.6/138.5
R3506	7030003520	S.RES ERJ3GEYJ 472 V (4.7 kΩ)	T	153.3/136.8
R3507	7030003640	S.RES ERJ3GEYJ 473 V (47 kΩ)	T	148.5/134
R3508	7030003640	S.RES ERJ3GEYJ 473 V (47 kΩ)	T	130.2/60.2
R3509	7030003520	S.RES ERJ3GEYJ 472 V (4.7 kΩ)	T	132.8/58.8
R3510	7030003560	S.RES ERJ3GEYJ 103 V (10 kΩ)	T	136.3/60.5
R3511	7030003720	S.RES ERJ3GEYJ 224 V (220 kΩ)	B	165.1/85.4
R3512	7030003720	S.RES ERJ3GEYJ 224 V (220 kΩ)	B	168.3/86.3
R3513	7030003720	S.RES ERJ3GEYJ 224 V (220 kΩ)	B	165.2/87
R3514	7030003720	S.RES ERJ3GEYJ 224 V (220 kΩ)	B	168.3/87.7
R3515	7030003720	S.RES ERJ3GEYJ 224 V (220 kΩ)	B	163.9/88.4
R3516	7030003720	S.RES ERJ3GEYJ 224 V (220 kΩ)	B	168/89.1
R3517	7030003720	S.RES ERJ3GEYJ 224 V (220 kΩ)	B	163.9/89.8
R3518	7030003720	S.RES ERJ3GEYJ 224 V (220 kΩ)	B	168/90.5
R3519	7030003720	S.RES ERJ3GEYJ 224 V (220 kΩ)	B	164.4/91.2
R3520	7030003720	S.RES ERJ3GEYJ 224 V (220 kΩ)	B	168/91.9
R3521	7030003720	S.RES ERJ3GEYJ 224 V (220 kΩ)	B	164.4/92.6

[MAIN-A UNIT]

REF NO.	ORDER NO.	DESCRIPTION	M.	H/V LOCATION
R3539	7030003720	S.RES ERJ3GEYJ 224 V (220 kΩ)	B	156.1/80.3
R3540	7030003720	S.RES ERJ3GEYJ 224 V (220 kΩ)	B	152.9/81.9
R3541	7030003720	S.RES ERJ3GEYJ 224 V (220 kΩ)	B	150.7/84.4
R3542	7030003720	S.RES ERJ3GEYJ 224 V (220 kΩ)	B	151.2/85.7
R3543	7030003720	S.RES ERJ3GEYJ 224 V (220 kΩ)	B	154.5/84.4
R3544	7030003720	S.RES ERJ3GEYJ 224 V (220 kΩ)	B	151.7/87
R3545	7030003720	S.RES ERJ3GEYJ 224 V (220 kΩ)	B	151.3/89.7
R3546	7030003720	S.RES ERJ3GEYJ 224 V (220 kΩ)	B	152.6/89.7
R3547	7030003720	S.RES ERJ3GEYJ 224 V (220 kΩ)	B	153.9/89.7
R3548	7030003720	S.RES ERJ3GEYJ 224 V (220 kΩ)	B	155.2/89.7
R3549	7030003720	S.RES ERJ3GEYJ 224 V (220 kΩ)	T	165.5/72.7
R3551	7030003800	S.RES ERJ3GEYJ 105 V (1 MΩ)	B	183.3/71.6
R3552	7030003680	S.RES ERJ3GEYJ 104 V (100 kΩ)	B	176.1/52
R3553	7030003680	S.RES ERJ3GEYJ 104 V (100 kΩ)	B	176.6/49.4
R3554	7030003580	S.RES ERJ3GEYJ 153 V (15 kΩ)	B	175.7/56.2
R3555	7030003580	S.RES ERJ3GEYJ 153 V (15 kΩ)	B	176.4/58.9
R3556	7030003580	S.RES ERJ3GEYJ 153 V (15 kΩ)	B	176.4/60.8
R3557	7030003580	S.RES ERJ3GEYJ 153 V (15 kΩ)	B	177.4/45.4
R3558	7030003440	S.RES ERJ3GEYJ 102 V (1 kΩ)	B	174.2/67.4
R3559	7030003270	S.RES ERJ3GEYJ 390 V (39 Ω)	B	178/69.5
R3571	7030003420	S.RES ERJ3GEYJ 681 V (680 Ω)	T	196.3/36.2
R3572	7030003630	S.RES ERJ3GEYJ 393 V (39 kΩ)	T	196.3/44
R3573	7030004120	S.RES ERJ3GEYJ 203 V (20 kΩ)	T	196.3/42.7
R3574	7030003560	S.RES ERJ3GEYJ 103 V (10 kΩ)	T	196.3/41.4
R3575	7030003560	S.RES ERJ3GEYJ 103 V (10 kΩ)	T	196.3/40.1
R3576	7030003560	S.RES ERJ3GEYJ 103 V (10 kΩ)	T	196.3/38.8
R3581	7030003420	S.RES ERJ3GEYJ 681 V (680 Ω)	T	192.9/36.2
R3582	7030003630	S.RES ERJ3GEYJ 393 V (39 kΩ)	T	192.9/44
R3583	7030004120	S.RES ERJ3GEYJ 203 V (20 kΩ)	T	192.9/42.7
R3584	7030003560	S.RES ERJ3GEYJ 103 V (10 kΩ)	T	192.9/41.4
R3585	7030003560	S.RES ERJ3GEYJ 103 V (10 kΩ)	T	192.9/40.1
R3586	7030003560	S.RES ERJ3GEYJ 103 V (10 kΩ)	T	192.9/38.8
R3591	7030003420	S.RES ERJ3GEYJ 681 V (680 Ω)	T	189.5/36.2
R3592	7030003630	S.RES ERJ3GEYJ 393 V (39 kΩ)	T	189.5/44
R3593	7030004120	S.RES ERJ3GEYJ 203 V (20 kΩ)	T	189.5/42.7
R3594	7030003560	S.RES ERJ3GEYJ 103 V (10 kΩ)	T	189.5/41.4
R3595	7030003560	S.RES ERJ3GEYJ 103 V (10 kΩ)	T	189.5/40.1
R3596	7030003560	S.RES ERJ3GEYJ 103 V (10 kΩ)	T	189.5/38.8
R3601	7030003440	S.RES ERJ3GEYJ 102 V (1 kΩ)	B	149.6/94.2
R3602	7030003640	S.RES ERJ3GEYJ 473 V (47 kΩ)	T	151.2/125.5
R3603	7030003480	S.RES ERJ3GEYJ 222 V (2.2 kΩ)	B	136.8/102
R3604	7030003440	S.RES ERJ3GEYJ 102 V (1 kΩ)	T	141.2/88.2
R3605	7030003440	S.RES ERJ3GEYJ 102 V (1 kΩ)	T	141.2/89.5
R3606	7030003640	S.RES ERJ3GEYJ 473 V (47 kΩ)	T	142/91
R3607	7030003640	S.RES ERJ3GEYJ 473 V (47 kΩ)	T	143.3/88.6
R3608	7030003440	S.RES ERJ3GEYJ 102 V (1 kΩ)	T	125.6/107.1
R3609	7030003440	S.RES ERJ3GEYJ 102 V (1 kΩ)	T	133/106.7
R3610	7030003640	S.RES ERJ3GEYJ 473 V (47 kΩ)	T	105.7/110.6
R3611	7030003640	S.RES ERJ3GEYJ 473 V (47 kΩ)	T	136.2/107.5
R3612	7030003440	S.RES ERJ3GEYJ 102 V (1 kΩ)	T	163.8/132.3
R3613	7030003640	S.RES ERJ3GEYJ 473 V (47 kΩ)	T	164.6/128.8
R3615	7030003600	S.RES ERJ3GEYJ 223 V (22 kΩ)	T	152.5/125.5
R3616	7030003600	S.RES ERJ3GEYJ 223 V (22 kΩ)	T	153.8/125.5
R3617	7030003440	S.RES ERJ3GEYJ 102 V (1 kΩ)	B	149.8/97.3
R3618	7030003440	S.RES ERJ3GEYJ 102 V (1 kΩ)	B	149.8/96
R3620	7030003640	S.RES ERJ3GEYJ 473 V (47 kΩ)	T	148.3/69.8
R3621	7030003640	S.RES ERJ3GEYJ 473 V (47 kΩ)	T	140.9/68.8
R3622	7030003440	S.RES ERJ3GEYJ 102 V (1 kΩ)	T	142.3/74.2
R3623	7030003640	S.RES ERJ3GEYJ 473 V (47 kΩ)	T	141.8/72.3
R3625	7030003440	S.RES ERJ3GEYJ 102 V (1 kΩ)	B	142.8/77.8
R3626	7030003440	S.RES ERJ3GEYJ 102 V (1 kΩ)	T	142.3/77.5
R3627	7030003800	S.RES ERJ3GEYJ 105 V (1 MΩ)	B	143.9/73.4
R3628	7030003800	S.RES ERJ3GEYJ 105 V (1 MΩ)	B	147/77
R3631	7030003640	S.RES ERJ3GEYJ 473 V (47 kΩ)	B	141.9/93.7
R3632	7030003640	S.RES ERJ3GEYJ 473 V (47 kΩ)	B	140.3/93.7
R3633	7030003640	S.RES ERJ3GEYJ 473 V (47 kΩ)	B	131/92.8
R3634	7030003640	S.RES ERJ3GEYJ 473 V (47 kΩ)	B	131/90.2
R3635	7030003640	S.RES ERJ3GEYJ 473 V (47 kΩ)	B	131/91.5
R3636	7030003640	S.RES ERJ3GEYJ 473 V (47 kΩ)	B	131/88.5
R3637	7030003440	S.RES ERJ3GEYJ 102 V (1 kΩ)	B	141.8/90.3
R3638	7030003440	S.RES ERJ3GEYJ 102 V (1 kΩ)	B	140.2/90.3
R3639	7030003440	S.RES ERJ3GEYJ 102 V (1 kΩ)	B	134.5/92.8
R3640	7030003440	S.RES ERJ3GEYJ 102 V (1 kΩ)	B	135/90.2
R3641	7030003440	S.RES ERJ3GEYJ 102 V (1 kΩ)	B	134.2/91.5
R3642	7030003440	S.RES ERJ3GEYJ 102 V (1 kΩ)	B	134.2/88.8
R3643	7030003440	S.RES ERJ3GEYJ 102 V (1 kΩ)	T	170/81.9
R3644	7030003440	S.RES ERJ3GEYJ 102 V (1 kΩ)	B	178.6/79.1
R3645	7030003640	S.RES ERJ3GEYJ 473 V (47 kΩ)	T	166.9/80
R3646	7030003640	S.RES ERJ3GEYJ 473 V (47 kΩ)	B	176.5/81.3
R3647	7030003440	S.RES ERJ3GEYJ 102 V (1 kΩ)	T	172.1/79.3
R3648	7030003640	S.RES ERJ3GEYJ 473 V (47 kΩ)	T	171.9/82.7
R3649	7510001580	S.TMR NTCG16 4BH 153KT	T	122.9/90.3
R3650	7030003520	S.RES ERJ3GEYJ 472 V (4.7 kΩ)	T	123.1/87.3
R3651	7030003680	S.RES ERJ3GEYJ 104 V (100 kΩ)	T	152.5/61.7
R3652	7030003720	S.RES ERJ3GEYJ 224 V (220 kΩ)	T	153/66.4
R3653	7030003720	S.RES ERJ3GEYJ 224 V (220 kΩ)	B	154/69.7
R3654	7030003440	S.RES ERJ3GEYJ 102 V (1 kΩ)	T	135.4/55.6
R3655	7030003640	S.RES ERJ3GEYJ 473 V (47 kΩ)	B	138.8/94.4
R3656	7030003640	S.RES ERJ3GEYJ 473 V (47 kΩ)	T	113.4/106.6
R3657	7030003720	S.RES ERJ3GEYJ 224 V (220 kΩ)	T	156/54.6
R3658	7030003720	S.RES ERJ3GEYJ 224 V (220 kΩ)	T	152.3/52.8
R3659	7030003480	S.RES ERJ3GEYJ 222 V (2.2 kΩ)	T	122.9/89
R3660	7030003520	S.RES ERJ3GEYJ 472 V (4.7 kΩ)	T	125.6/89.5

M.=Mounted side (T: Mounted on the Top side, B: Mounted on the Bottom side)

[MAIN-A UNIT]

REF NO.	ORDER NO.	DESCRIPTION	M.	H/V LOCATION
R3701	7030003640	S.RES ERJ3GEYJ 473 V (47 kΩ)	T	168.2/79.6
R3702	7030003640	S.RES ERJ3GEYJ 473 V (47 kΩ)	B	149.1/49.2
R3703	7030003640	S.RES ERJ3GEYJ 473 V (47 kΩ)	B	149.2/41.4
R3704	7030003640	S.RES ERJ3GEYJ 473 V (47 kΩ)	T	142.5/46.8
R3705	7030003800	S.RES ERJ3GEYJ 105 V (1 MΩ)	T	136.8/48.4
R3706	7030003440	S.RES ERJ3GEYJ 102 V (1 kΩ)	T	133.6/48.7
R3707	7030003440	S.RES ERJ3GEYJ 102 V (1 kΩ)	T	138.4/46.5
R3709	7030003440	S.RES ERJ3GEYJ 102 V (1 kΩ)	T	169.7/86.2
R3710	7030003440	S.RES ERJ3GEYJ 102 V (1 kΩ)	B	149.1/45.3
R3711	7030003440	S.RES ERJ3GEYJ 102 V (1 kΩ)	B	149.1/46.6
R3712	7030003440	S.RES ERJ3GEYJ 102 V (1 kΩ)	B	169.9/82.3
R3721	7030003640	S.RES ERJ3GEYJ 473 V (47 kΩ)	T	156.4/29
R3722	7030003640	S.RES ERJ3GEYJ 473 V (47 kΩ)	T	144.2/30.9
R3723	7030003580	S.RES ERJ3GEYJ 153 V (15 kΩ)	T	139.7/30.9
R3724	7030003440	S.RES ERJ3GEYJ 102 V (1 kΩ)	T	141.6/30.9
R3725	7030003640	S.RES ERJ3GEYJ 473 V (47 kΩ)	B	146.1/44
R3726	7030003440	S.RES ERJ3GEYJ 102 V (1 kΩ)	T	142.7/42.3
R3727	7030003440	S.RES ERJ3GEYJ 102 V (1 kΩ)	T	105.1/44.9
R3728	7030003640	S.RES ERJ3GEYJ 473 V (47 kΩ)	T	104.3/43
R3732	7030003640	S.RES ERJ3GEYJ 473 V (47 kΩ)	T	169/114.5
R3740	7030009891	S.RES ERA3YED 151V	B	74.7/21.2
R3741	7030009851	S.RES ERA3YED 271V	B	73.1/22.5
R3742	7030003600	S.RES ERJ3GEYJ 223 V (22 kΩ)	B	77.7/110.4
R3743	7030003680	S.RES ERJ3GEYJ 104 V (100 kΩ)	B	77.3/108.8
R3744	7030003280	S.RES ERJ3GEYJ 470 V (47 Ω)	B	38.2/41.2
R3745	7030003600	S.RES ERJ3GEYJ 223 V (22 kΩ)	T	116.1/76.5
R3746	7030003560	S.RES ERJ3GEYJ 103 V (10 kΩ)	T	114.8/76.5
R3753	7030003440	S.RES ERJ3GEYJ 102 V (1 kΩ)	B	129.4/68.5
R3754	7030003440	S.RES ERJ3GEYJ 102 V (1 kΩ)	B	128.2/70.2
R3755	7030003440	S.RES ERJ3GEYJ 102 V (1 kΩ)	B	128.2/71.5
R3756	7030003440	S.RES ERJ3GEYJ 102 V (1 kΩ)	B	128.2/72.8
R3757	7030003760	S.RES ERJ3GEYJ 474 V (470 kΩ)	B	128.2/74.1
R3758	7030003440	S.RES ERJ3GEYJ 102 V (1 kΩ)	B	128.2/75.4
R3759	7030003640	S.RES ERJ3GEYJ 473 V (47 kΩ)	T	137.1/76.7
R3761	7030003320	S.RES ERJ3GEYJ 101 V (100 Ω)	B	128.2/76.7
R3762	7030003440	S.RES ERJ3GEYJ 102 V (1 kΩ)	B	128.4/78
R3763	7030003440	S.RES ERJ3GEYJ 102 V (1 kΩ)	B	128.4/79.3
R3764	7030003320	S.RES ERJ3GEYJ 101 V (100 Ω)	B	128.4/80.6
R3765	7030003440	S.RES ERJ3GEYJ 102 V (1 kΩ)	B	128.4/81.9
R3766	7030003440	S.RES ERJ3GEYJ 102 V (1 kΩ)	B	128.4/83.2
R3767	7030003440	S.RES ERJ3GEYJ 102 V (1 kΩ)	B	128.4/84.5
R3768	7030003440	S.RES ERJ3GEYJ 102 V (1 kΩ)	B	128.4/85.8
R3769	7030003640	S.RES ERJ3GEYJ 473 V (47 kΩ)	T	128.4/83.2
R3770	7030003640	S.RES ERJ3GEYJ 473 V (47 kΩ)	T	128.4/84.5
R3771	7030003640	S.RES ERJ3GEYJ 473 V (47 kΩ)	T	128.4/85.8
R3772	7030003640	S.RES ERJ3GEYJ 473 V (47 kΩ)	T	155.7/126.3
R3773	7030003640	S.RES ERJ3GEYJ 473 V (47 kΩ)	T	155.7/125
R3774	7030003640	S.RES ERJ3GEYJ 473 V (47 kΩ)	T	155.7/123.7
R3775	7030003540	S.RES ERJ3GEYJ 682 V (6.8 kΩ)	T	154.6/130.4
R3776	7030003620	S.RES ERJ3GEYJ 333 V (33 kΩ)	T	154.6/131.7
R3777	7030003580	S.RES ERJ3GEYJ 153 V (15 kΩ)	T	157.3/131.7
R3778	7030003640	S.RES ERJ3GEYJ 473 V (47 kΩ)	T	157.3/130.4
R3779	7030003680	S.RES ERJ3GEYJ 104 V (100 kΩ)	T	162.4/125.4
R3780	7030003440	S.RES ERJ3GEYJ 102 V (1 kΩ)	T	163.7/125.4
R3781	7030003640	S.RES ERJ3GEYJ 473 V (47 kΩ)	B	162.7/97.1
R3782	7030003640	S.RES ERJ3GEYJ 473 V (47 kΩ)	B	161.2/97.1
R3783	7030003640	S.RES ERJ3GEYJ 473 V (47 kΩ)	T	134.4/58.8
R3784	7030003680	S.RES ERJ3GEYJ 104 V (100 kΩ)	T	156.7/51.6
R3785	7030003640	S.RES ERJ3GEYJ 473 V (47 kΩ)	B	145.2/97.3
R3786	7030003680	S.RES ERJ3GEYJ 104 V (100 kΩ)	B	143.3/88.4
R3787	7030003560	S.RES ERJ3GEYJ 103 V (10 kΩ)	T	122.2/79
R3801	7030003360	S.RES ERJ3GEYJ 221 V (220 Ω)	T	82.2/15.4
R3802	7030003360	S.RES ERJ3GEYJ 221 V (220 Ω)	T	84.8/15.3
R3803	7030003360	S.RES ERJ3GEYJ 221 V (220 Ω)	B	79.6/16.4
C102	4030006880	S.CER C1608 JB 1H 472K-T	T	86.1/21.7
C103	4030011600	S.CER C1608 JB 1E 104K-T	T	91.8/24.6
C104	4030011600	S.CER C1608 JB 1E 104K-T	T	91.9/28.3
C113	4030006850	S.CER C1608 JB 1H 471K-T	B	49.9/20.5
C115	4030011600	S.CER C1608 JB 1E 104K-T	B	48.8/44.6
C116	4030011600	S.CER C1608 JB 1E 104K-T	B	48.7/37.5
C118	4510006220	S.ELE ECEV1CA101UP	T	53.2/40.8
C119	4030006880	S.CER C1608 JB 1H 472K-T	B	50.3/52.9
C121	4030011600	S.CER C1608 JB 1E 104K-T	B	47.5/11.2
C122	4030011600	S.CER C1608 JB 1E 104K-T	B	49.2/9.4
C123	4030011600	S.CER C1608 JB 1E 104K-T	B	59.9/29.2
C125	4030011600	S.CER C1608 JB 1E 104K-T	T	45.6/41.9
C126	4030011600	S.CER C1608 JB 1E 104K-T	B	33.6/60.3
C127	4030006880	S.CER C1608 JB 1H 472K-T	B	42.7/65.2
C129	4030006880	S.CER C1608 JB 1H 47		

[MAIN-A UNIT]

REF NO.	ORDER NO.	DESCRIPTION	M.	H/V LOCATION
C153	4030011600	S.CER C1608 JB 1E 104K-T	T	46.2/89.5
C154	4510006220	S.ELE ECEV1CA101UP	T	52.1/101.3
C155	4030011600	S.CER C1608 JB 1E 104K-T	T	49.9/90.3
C156	4030011600	S.CER C1608 JB 1E 104K-T	T	52.7/91.2
C157	4030006860	S.CER C1608 JB 1H 102K-T	B	47.7/99.9
C158	4340000250	S.MLR ECHU 1C 104JX5	T	34.9/100.1
C201	4510004630	S.ELE ECEV1CA100SR	T	31.7/114.8
C202	4510004630	S.ELE ECEV1CA100SR	T	42.1/112.2
C203	4340000200	S.MLR ECHU 1H 271JX5	T	35.7/105.7
C204	4340000230	S.MLR ECHU 1H 272JB5	T	35.7/103.9
C205	4340000240	S.MLR ECHU 1C 682JX5	T	34.4/108.1
C206	4340000220	S.MLR ECHU 1H 681JB5	T	32.6/107.7
C207	4340000210	S.MLR ECHU 1H 331JX5	T	39.8/108.3
C208	4340000190	S.MLR ECHU 1H 101JX5	T	39.8/106.5
C209	4510006670	S.ELE ECEV1CA471P	T	173.8/142.2
C211	4030006880	S.CER C1608 JB 1H 472K-T	B	60.4/82
C221	4030006860	S.CER C1608 JB 1H 102K-T	B	42.7/93.5
C222	4510004630	S.ELE ECEV1CA100SR	T	32/96.2
C223	4030011600	S.CER C1608 JB 1E 104K-T	T	31.7/93
C224	4550006080	S.TAN TEESVA 1C 106M8L	B	43.7/85.4
C225	4030011600	S.CER C1608 JB 1E 104K-T	T	40.9/91.4
C226	4030011600	S.CER C1608 JB 1E 104K-T	T	35.5/81.4
C227	4510004630	S.ELE ECEV1CA100SR	T	30.7/79.4
C228	4030011600	S.CER C1608 JB 1E 104K-T	B	35/87.7
C229	4030006850	S.CER C1608 JB 1H 471K-T	T	41.8/88.7
C231	4030011600	S.CER C1608 JB 1E 104K-T	B	36.8/87.7
C241	4030011600	S.CER C1608 JB 1E 104K-T	T	66.8/45.2
C242	4030006880	S.CER C1608 JB 1H 472K-T	B	41.7/57.8
C243	4030006880	S.CER C1608 JB 1H 472K-T	T	42.4/84.8
C244	4030006880	S.CER C1608 JB 1H 472K-T	T	43.1/83.5
C245	4030011600	S.CER C1608 JB 1E 104K-T	B	43.7/80.4
C246	4030011600	S.CER C1608 JB 1E 104K-T	T	48.5/82.6
C247	4030011600	S.CER C1608 JB 1E 104K-T	T	42.4/87.4
C261	4030006880	S.CER C1608 JB 1H 472K-T	B	45.6/77.2
C262	4030008920	S.CER C1608 JB 1H 473K-T	B	64.3/43.7
C264	4030011600	S.CER C1608 JB 1E 104K-T	B	61.5/32.6
C266	4030006860	S.CER C1608 JB 1H 102K-T	T	66.4/38.8
C267	4510004630	S.ELE ECEV1CA100SR	T	59.3/40.7
C268	4030011600	S.CER C1608 JB 1E 104K-T	B	63.6/40.5
C271	4030011600	S.CER C1608 JB 1E 104K-T	T	34.3/17.2
C272	4030011600	S.CER C1608 JB 1E 104K-T	B	34.9/13.4
C274	4030011600	S.CER C1608 JB 1E 104K-T	T	30.6/23.4
C275	4030011600	S.CER C1608 JB 1E 104K-T	B	30.6/23.7
C279	4030011600	S.CER C1608 JB 1E 104K-T	T	23.3/38.3
C280	4030006880	S.CER C1608 JB 1H 472K-T	T	27.1/47.9
C281	4030006850	S.CER C1608 JB 1H 471K-T	T	31.3/51.9
C283	4030011600	S.CER C1608 JB 1E 104K-T	T	31.5/36.4
C284	4510004640	S.ELE ECEV1CA470SP	T	38/38.5
C285	4030011810	S.CER C1608 JB 1A 224K-T	T	41.2/49.3
C286	4510006240	S.ELE ECEV1CA221P	T	37.3/60.9
C287	4510004640	S.ELE ECEV1CA470SP	T	36.9/30.4
C288	4030011600	S.CER C1608 JB 1E 104K-T	T	24.5/50.5
C289	4030006870	S.CER C1608 JB 1H 222K-T	T	30/51.2
C301	4510005890	S.ELE ECEV1AAN100R	T	93.6/104.3
C302	4510005890	S.ELE ECEV1AAN100R	T	80.7/93.7
C303	4510005890	S.ELE ECEV1AAN100R	T	97.5/99.9
C304	4030011600	S.CER C1608 JB 1E 104K-T	B	89/101.7
C305	4030011600	S.CER C1608 JB 1E 104K-T	B	91.6/100.9
C306	4030011600	S.CER C1608 JB 1E 104K-T	T	94.7/113.5
C307	4030011600	S.CER C1608 JB 1E 104K-T	T	98.5/110.6
C308	4510005890	S.ELE ECEV1AAN100R	T	95.5/122.7
C311	4510005860	S.ELE ECEV1HA2R2SR	T	87.5/98.9
C312	4030006870	S.CER C1608 JB 1H 222K-T	B	85.6/101.7
C313	4510004630	S.ELE ECEV1CA100SR	T	81.6/98.9
C314	4510004630	S.ELE ECEV1CA100SR	T	86.5/104
C315	4510004630	S.ELE ECEV1CA100SR	T	63.7/117.5
C316	4510006670	S.ELE ECEV1CA471P	T	87.1/116.4
C317	4030012600	S.CER C2012 JB 1A 105M-T	B	82.9/102
C318	4510004440	S.ELE ECEV1HA010SR	T	92.7/99
C319	4030012600	S.CER C2012 JB 1A 105M-T	T	91.9/108.7
C320	4030012600	S.CER C2012 JB 1A 105M-T	B	96.7/98.9
C321	4030006880	S.CER C1608 JB 1H 472K-T	T	107.3/74.9
C322	4030006880	S.CER C1608 JB 1H 472K-T	T	105.4/74.5
C323	4030006860	S.CER C1608 JB 1H 102K-T	T	104.6/80.5
C324	4030006860	S.CER C1608 JB 1H 102K-T	T	106/77.7
C325	4030011600	S.CER C1608 JB 1E 104K-T	T	108.5/76.9
C326	4030011600	S.CER C1608 JB 1E 104K-T	T	109.9/76.9
C327	4030012600	S.CER C2012 JB 1A 105M-T	B	90.3/106.2
C331	4510004630	S.ELE ECEV1CA100SR	T	76.4/141.8
C332	4510004630	S.ELE ECEV1CA100SR	T	79.1/135.9
C333	4030008950	S.CER C2012 JB 1C 823K-T	B	88.9/145.2
C334	4510004630	S.ELE ECEV1CA100SR	T	81.8/142.4
C335	4030008880	S.CER C1608 JB 1H 223K-T	T	84.1/148.3
C336	4030011600	S.CER C1608 JB 1E 104K-T	B	93.2/146.8
C337	4510006670	S.ELE ECEV1CA471P	T	102.4/138.8
C338	4510006670	S.ELE ECEV1CA471P	T	91.6/138.8
C340	4510006220	S.ELE ECEV1CA101UP	T	88.3/128.1
C341	4030011600	S.CER C1608 JB 1E 104K-T	B	81.2/145.9
C351	4030006880	S.CER C1608 JB 1H 472K-T	T	15.5/110.9
C352	4030006880	S.CER C1608 JB 1H 472K-T	T	18.2/110.9
C353	4030006880	S.CER C1608 JB 1H 472K-T	B	5.7/89.9
C354	4030006880	S.CER C1608 JB 1H 472K-T	B	13.3/95.2
C361	4030011600	S.CER C1608 JB 1E 104K-T	B	93.3/97.8

M.=Mounted side (T: Mounted on the Top side, B: Mounted on the Bottom side)

[MAIN-A UNIT]

REF NO.	ORDER NO.	DESCRIPTION	M.	H/V LOCATION
C362	4030011600	S.CER C1608 JB 1E 104K-T	B	88.4/93.7
C363	4510004630	S.ELE ECEV1CA100SR	T	59.2/104.5
C364	4510004630	S.ELE ECEV1CA100SR	T	65.7/103.7
C365	4550000270	S.TAN TEESVA 1E 474M8L	B	69.8/107.2
C371	4030012600	S.CER C2012 JB 1A 105M-T	B	78.7/94
C372	4550000460	S.TAN TEESVA 1C 105M8L	B	72.5/96.9
C374	4510004630	S.ELE ECEV1CA100SR	T	75.4/95.5
C375	4510004630	S.ELE ECEV1CA100SR	T	75.3/100.3
C376	4030006900	S.CER C1608 JB 1H 103K-T	T	71.7/97.9
C377	4510006670	S.ELE ECEV1CA471P	T	78.7/108.1
C378	4030012600	S.CER C2012 JB 1A 105M-T	B	72/101.6
C379	4510004440	S.ELE ECEV1HA010SR	T	65.1/109.3
C390	4030011600	S.CER C1608 JB 1E 104K-T	T	101.6/82.7
C391	4030011600	S.CER C1608 JB 1E 104K-T	T	109.9/84.8
C392	4030011600	S.CER C1608 JB 1E 104K-T	T	81.1/51
C453	4510004440	S.ELE ECEV1HA010SR	T	121.7/124.3
C456	4030007130	S.CER C1608 CH 1H 101J-T	B	134.9/126.2
C457	4510005860	S.ELE ECEV1HA2R2SR	T	134.2/118.4
C458	4030008880	S.CER C1608 JB 1H 223K-T	B	131.5/126.2
C459	4030010040	S.CER C1608 JB 1H 561K-T	B	131.5/128
C460	4030008880	S.CER C1608 JB 1H 223K-T	T	129.1/126.8
C461	4030012600	S.CER C2012 JB 1A 105M-T	B	121.5/116.1
C462	4030007130	S.CER C1608 CH 1H 101J-T	B	120/119.3
C463	4030011600	S.CER C1608 JB 1E 104K-T	B	121.5/124
C464	4510004630	S.ELE ECEV1CA100SR	T	122.3/118.2
C465	4030011600	S.CER C1608 JB 1E 104K-T	B	134/111.9
C466	4510004440	S.ELE ECEV1HA010SR	T	117.5/115.7
C467	4030006860	S.CER C1608 JB 1H 102K-T	T	116.8/123.3
C471	4030012600	S.CER C2012 JB 1A 105M-T	T	124.6/112.5
C472	4510005860	S.ELE ECEV1HA2R2SR	T	128.6/112.7
C473	4510004630	S.ELE ECEV1CA100SR	T	94.7/61.1
C474	4510006220	S.ELE ECEV1CA101UP	T	128.2/120.1
C475	4030012600	S.CER C2012 JB 1A 105M-T	T	134.9/122.7
C476	4030011600	S.CER C1608 JB 1E 104K-T	B	126.8/109.3
C477	4510006670	S.ELE ECEV1CA471P	T	119.5/106.5
C502	4030012600	S.CER C2012 JB 1A 105M-T	B	84.3/46.4
C504	4030012600	S.CER C2012 JB 1A 105M-T	T	80.1/42.6
C506	4030012610	S.CER C2012 JB 1C 474K-T	T	81.9/41.9
C507	4030011600	S.CER C1608 JB 1E 104K-T	T	83/28.5
C508	4550006080	S.TAN TEESVB2 1C 106M8L	T	76.7/31.6
C510	4030012600	S.CER C2012 JB 1A 105M-T	B	79.4/46
C552	4030011600	S.CER C1608 JB 1E 104K-T	T	93.5/38.5
C553	4030011600	S.CER C1608 JB 1E 104K-T	T	97.5/40.6
C561	4510004630	S.ELE ECEV1CA100SR	T	94.6/32.3
C571	4510004630	S.ELE ECEV1CA100SR	T	88.7/35.3
C572	4030011600	S.CER C1608 JB 1E 104K-T	B	89.8/26.9
C573	4030011600	S.CER C1608 JB 1E 104K-T	T	95.4/37.7
C601	4510005810	S.ELE ECEV1HAR47R	T	95.1/19.1
C611	4510005810	S.ELE ECEV1HAR47R	T	103.6/9.2
C631	4030006880	S.CER C1608 JB 1H 472K-T	B	7.2/21.6
C632	4030006880	S.CER C1608 JB 1H 472K-T	B	7.2/31.5
C641	4030006880	S.CER C1608 JB 1H 472K-T	B	30.4/94
C642	4030006880	S.CER C1608 JB 1H 472K-T	B	30.4/95.8
C643	4030006880	S.CER C1608 JB 1H 472K-T	T	22.8/114.4
C651	4030006880	S.CER C1608 JB 1H 472K-T	B	8.7/37.4
C652	4030006880	S.CER C1608 JB 1H 472K-T	T	23.5/3.2
C653	4030006880	S.CER C1608 JB 1H 472K-T	B	6.4/38.5
C661	4030006880	S.CER C1608 JB 1H 472K-T	B	21.8/24.4
C662	4030006880	S.CER C1608 JB 1H 472K-T	B	21.7/18.3
C663	4030006880	S.CER C1608 JB 1H 472K-T	T	5.7/32
C664	4030006880	S.CER C1608 JB 1H 472K-T	B	23.5/20.9
C665	4030006880	S.CER C1608 JB 1H 472K-T	T	13.7/2.9
C666	4030006880	S.CER C1608 JB 1H 472K-T	B	21.1/30.3
C667	4030006880	S.CER C1608 JB 1H 472K-T	T	22.2/7.7
C668	4030006880	S.CER C1608 JB 1H 472K-T	B	19.6/42.4
C669	4030006880	S.CER C1608 JB 1H 472K-T	B	16.2/31.5
C670	4030006880	S.CER C1608 JB 1H 472K-T	B	22.2/40.3
C681	4030006880	S.CER C1608 JB 1H 472K-T	B	27.9/73.9
C691	4030006880	S.CER C1608 JB 1H 472K-T	T	21.5/117.1
C692	4030006880	S.CER C1608 JB 1H 472K-T	T	22.8/117.1
C695	4030006880	S.CER C1608 JB 1H 472K-T	B	9.9/140.2
C701	4030007130	S.CER C1608 CH 1H 101J-T	B	14.6/81
C702	4030011600	S.CER C1608 JB 1E 104K-T	T	125/35.2
C703	4030011600	S.CER C1608 JB 1E 104K-T	T	127/31.9
C704	4030011600	S.CER C1608 JB 1E 104K-T	T	127/30.6
C705	4030011600	S.CER C1608 JB 1E 104K-T	T	127/29.3
C706	4030011600	S.CER C1608 JB 1E 104K-T	T	21.1/137.8
C707	4030011600	S.CER C1608 JB 1E 104K-T	T	19.9/148.8
C708	4030011600	S.CER C1608 JB 1E 104K-T	T	22.4/137.8
C709	4030011600	S.CER C1608 JB 1E 104K-T	T	21.9/148.8
C710	4030011600	S.CER C1608 JB 1E 104K-T	T	23.7/137.8
C711	4030011600	S.CER C1608 JB 1E 104K-T	T	23.9/148.8
C712	4030011600	S.CER C1608 JB 1E 104K-T	T	25.9/148.8
C713	4030011600	S.CER C1608 JB 1E 104K-T	T	27.9/148.8
C714	4030011600	S.CER C1608 JB 1E 104K-T	T	29.9/148.8
C715	40300116			

[MAIN-A UNIT]

REF NO.	ORDER NO.	DESCRIPTION	M.	H/V LOCATION
C807	4030011600	S.CER C1608 JB 1E 104K-T	B	23.6/135.4
C808	4510006220	S.ELE ECEV1CA101UP	T	22.6/128.5
C813	4510006220	S.ELE ECEV1CA101UP	T	30.2/128
C814	4030011600	S.CER C1608 JB 1E 104K-T	B	68/56.8
C815	4510004630	S.ELE ECEV1CA100SR	T	68.1/51.5
C816	4030011600	S.CER C1608 JB 1E 104K-T	B	66.4/55
C817	4510006220	S.ELE ECEV1CA101UP	T	65.9/57.5
C818	4550006250	S.TAN TEESVA 1A 106M8L	T	131.5/141.3
C819	4550006050	S.TAN TEESVA 0J 106M8L	T	138.7/141.3
C826	4030011600	S.CER C1608 JB 1E 104K-T	B	72.2/12.5
C827	4030011600	S.CER C1608 JB 1E 104K-T	B	63.2/7.7
C828	4030011600	S.CER C1608 JB 1E 104K-T	B	65.2/6.3
C829	4030011600	S.CER C1608 JB 1E 104K-T	B	68.2/12.5
C831	4030011600	S.CER C1608 JB 1E 104K-T	B	70.6/4.6
C832	4030011600	S.CER C1608 JB 1E 104K-T	B	74.2/12.5
C833	4030006880	S.CER C1608 JB 1H 472K-T	B	76.8/6.9
C834	4030011600	S.CER C1608 JB 1E 104K-T	T	145.8/2.7
C835	4510006220	S.ELE ECEV1CA101UP	T	29.9/4.8
C836	4550006770	S.TAN TEESVD2 1C 476M-12R	B	81.6/4.8
C837	4030006880	S.CER C1608 JB 1H 472K-T	B	138.2/128
C838	4030006880	S.CER C1608 JB 1H 472K-T	T	145.1/11.9
C853	4030011600	S.CER C1608 JB 1E 104K-T	T	153.9/2.7
C854	4030006880	S.CER C1608 JB 1H 472K-T	T	186.5/5.9
C855	4030006880	S.CER C1608 JB 1H 472K-T	T	197.2/5.7
C856	4030011600	S.CER C1608 JB 1E 104K-T	T	155.5/4
C857	4030011600	S.CER C1608 JB 1E 104K-T	T	197.2/6.4
C859	4030011600	S.CER C1608 JB 1E 104K-T	T	197.2/7.0
C861	4030011600	S.CER C1608 JB 1E 104K-T	T	197.2/90.9
C863	4030011600	S.CER C1608 JB 1E 104K-T	T	197.2/99.9
C864	4030011600	S.CER C1608 JB 1E 104K-T	T	197.2/84.9
C865	4030006880	S.CER C1608 JB 1H 472K-T	T	197.2/81.9
C866	4030006880	S.CER C1608 JB 1H 472K-T	T	197.2/80.6
C867	4510006220	S.ELE ECEV1CA101UP	T	137.1/129.8
C868	4030011600	S.CER C1608 JB 1E 104K-T	B	137.5/125.4
C869	4510006850	S.ELE ECEV1CA4R7NR (16V 4.7)	T	114.7/91.6
C3001	4030012600	S.CER C2012 JB 1A 105M-T	T	95.9/76.3
C3003	4030011600	S.CER C1608 JB 1E 104K-T	B	89.4/63
C3004	4030012600	S.CER C2012 JB 1A 105M-T	B	94.5/68.3
C3005	4030011600	S.CER C1608 JB 1E 104K-T	B	86.8/62.3
C3006	4030011600	S.CER C1608 JB 1E 104K-T	B	77.6/62.3
C3008	4510006850	S.ELE ECEV1CA4R7NR (16V 4.7)	T	84.2/73.9
C3009	4510007570	S.ELE EEEVHB1C220UR	T	87.6/60.6
C3010	4510006670	S.ELE ECEV1CA471P	T	92.1/69.1
C3011	4510006670	S.ELE ECEV1CA471P	T	76.8/63.6
C3012	4030008920	S.CER C1608 JB 1H 473K-T	B	85/77.8
C3013	4030011600	S.CER C1608 JB 1E 104K-T	T	95.8/86.2
C3014	4510004630	S.ELE ECEV1CA100SR	T	91.1/82.1
C3015	4510004630	S.ELE ECEV1CA100SR	T	80/87.4
C3016	4510004440	S.ELE ECEV1HA010SR	T	74.9/90.7
C3017	4510004630	S.ELE ECEV1CA100SR	T	74.5/79
C3018	4510004630	S.ELE ECEV1CA100SR	T	79.6/78.1
C3019	4510004630	S.ELE ECEV1CA100SR	T	87.1/89.3
C3020	4510004630	S.ELE ECEV1CA100SR	T	74.5/84.9
C3021	4030011600	S.CER C1608 JB 1E 104K-T	B	88/76.8
C3025	4510004630	S.ELE ECEV1CA100SR	T	92.2/77
C3030	4030011600	S.CER C1608 JB 1E 104K-T	T	102.2/92.1
C3031	4030011600	S.CER C1608 JB 1E 104K-T	T	104.5/97
C3032	4030011600	S.CER C1608 JB 1E 104K-T	T	81.8/83.3
C3501	4030007020	S.CER C1608 CH 1H 120J-T	T	140.3/95.7
C3502	4030007020	S.CER C1608 CH 1H 120J-T	T	143/94.8
C3503	4030006900	S.CER C1608 JB 1H 103K-T	T	144.7/89.3
C3504	4030006900	S.CER C1608 JB 1H 103K-T	T	140.7/81.9
C3505	4030006900	S.CER C1608 JB 1H 103K-T	T	156.3/68.7
C3506	4030006880	S.CER C1608 JB 1H 472K-T	T	143.3/136.9
C3507	4030006900	S.CER C1608 JB 1H 103K-T	T	150.3/139.8
C3508	4030011600	S.CER C1608 JB 1E 104K-T	T	134.1/56.1
C3509	4030006900	S.CER C1608 JB 1H 103K-T	T	132.8/56.1
C3510	4510004630	S.ELE ECEV1CA100SR	T	128.7/53.7
C3511	4030006900	S.CER C1608 JB 1H 103K-T	T	162/94.8
C3512	4030006900	S.CER C1608 JB 1H 103K-T	T	166.8/90.2
C3513	4510006670	S.ELE ECEV1CA471P	T	165.7/100.9
C3552	4030006900	S.CER C1608 JB 1H 103K-T	T	158/51.6
C3553	4030006900	S.CER C1608 JB 1H 103K-T	T	176.2/69.4
C3554	4030006900	S.CER C1608 JB 1H 103K-T	T	182.3/70.3
C3555	4030006900	S.CER C1608 JB 1H 103K-T	T	187.4/32.5
C3556	4030006900	S.CER C1608 JB 1H 103K-T	T	167.1/41.6
C3557	4030006900	S.CER C1608 JB 1H 103K-T	T	188.2/34.4
C3558	4510006220	S.ELE ECEV1CA101UP	T	183.5/4.5
C3560	4030006900	S.CER C1608 JB 1H 103K-T	B	171.9/51.4
C3561	4030006880	S.CER C1608 JB 1H 472K-T	T	171.1/72.2
C3562	4510006220	S.ELE ECEV1CA101UP	T	176.8/80.5
C3601	4030011600	S.CER C1608 JB 1E 104K-T	T	149/139.8
C3602	4510006220	S.ELE ECEV1CA101UP	T	126.9/134.6
C3603	4030011600	S.CER C1608 JB 1E 104K-T	T	122.4/134.3
C3604	4510006670	S.ELE ECEV1CA471P	T	114.8/61.1
C3605	4030011600	S.CER C1608 JB 1E 104K-T	T	126/60.8
C3606	4030007170	S.CER C1608 CH 1H 221J-T	B	149.6/92.9
C3607	4030006860	S.CER C1608 JB 1H 102K-T	T	139.8/85.3
C3608	4030006900	S.CER C1608 JB 1H 103K-T	T	134.9/107.5
C3609	4030006900	S.CER C1608 JB 1H 103K-T	T	127.5/107.9
C3610	4030006900	S.CER C1608 JB 1H 103K-T	T	164.6/130.2
C3611	4030006880	S.CER C1608 JB 1H 472K-T	B	153/96
C3612	4030006880	S.CER C1608 JB 1H 472K-T	B	153/97.6

M.=Mounted side (T: Mounted on the Top side, B: Mounted on the Bottom side)

[MAIN-A UNIT]

REF NO.	ORDER NO.	DESCRIPTION	M.	H/V LOCATION
C3614	4030006880	S.CER C1608 JB 1H 472K-T	T	148.3/71.1
C3615	4030006880	S.CER C1608 JB 1H 472K-T	T	139.6/68.8
C3624	4030006880	S.CER C1608 JB 1H 472K-T	T	143.1/72.3
C3625	4030006880	S.CER C1608 JB 1H 472K-T	B	143.9/75.2
C3626	4030006880	S.CER C1608 JB 1H 472K-T	B	146/77.9
C3631	4030006880	S.CER C1608 JB 1H 472K-T	B	132.5/94.5
C3632	4030006880	S.CER C1608 JB 1H 472K-T	B	144.4/85.6
C3633	4030006880	S.CER C1608 JB 1H 472K-T	B	145.3/84.7
C3634	4030006880	S.CER C1608 JB 1H 472K-T	B	146.2/83.8
C3635	4030006880	S.CER C1608 JB 1H 472K-T	B	147.1/82.8
C3636	4030006880	S.CER C1608 JB 1H 472K-T	B	148.1/81.3
C3637	4030006880	S.CER C1608 JB 1H 472K-T	B	149/81
C3638	4030011600	S.CER C1608 JB 1E 104K-T	T	121.8/94.9
C3641	4030006880	S.CER C1608 JB 1H 472K-T	T	170.8/79.3
C3642	4030006880	S.CER C1608 JB 1H 472K-T	B	177.8/81.3
C3643	4030006880	S.CER C1608 JB 1H 472K-T	T	169.5/80
C3651	4030006900	S.CER C1608 JB 1H 103K-T	T	150.4/62.8
C3652	4030006900	S.CER C1608 JB 1H 103K-T	T	167.1/31.2
C3653	4030006900	S.CER C1608 JB 1H 103K-T	B	143.5/38.8
C3654	4030006900	S.CER C1608 JB 1H 103K-T	T	142.2/68.8
C3655	4030006930	S.CER C1608 CH 1H 020C-T	T	134.6/53.7
C3656	4030006900	S.CER C1608 JB 1H 103K-T	T	136.2/51
C3657	4030006900	S.CER C1608 JB 1H 103K-T	B	152.4/50.3
C3658	4030006880	S.CER C1608 JB 1H 472K-T	T	154.9/52.7
C3659	4030007130	S.CER C1608 CH 1H 101J-T	T	155.6/56.5
C3702	4030006880	S.CER C1608 JB 1H 472K-T	T	170.9/107.5
C3704	4030006880	S.CER C1608 JB 1H 472K-T	B	146.4/39.8
C3706	4030006880	S.CER C1608 JB 1H 472K-T	T	169.7/87.5
C3707	4030006880	S.CER C1608 JB 1H 472K-T	B	149.1/44
C3708	4030006880	S.CER C1608 JB 1H 472K-T	B	149.9/47.9
C3709	4030006880	S.CER C1608 JB 1H 472K-T	B	168.3/84.6
C3711	4030006900	S.CER C1608 JB 1H 103K-T	T	135.5/48.4
C3712	4030006900	S.CER C1608 JB 1H 103K-T	T	141.4/50.8
C3721	4030006880	S.CER C1608 JB 1H 472K-T	T	159.2/29
C3722	4030006880	S.CER C1608 JB 1H 472K-T	T	142.9/30.7
C3723	4030006880	S.CER C1608 JB 1H 472K-T	B	146.1/42.9
C3724	4030006880	S.CER C1608 JB 1H 472K-T	T	104.3/41.7
C3725	4030011600	S.CER C1608 JB 1E 104K-T	T	136.5/32.6
C3750	4030012610	S.CER C2012 JB 1C 474K-T	T	120.5/72
C3751	4030006880	S.CER C1608 JB 1H 472K-T	B	132.6/66.1
C3752	4030006880	S.CER C1608 JB 1H 472K-T	B	133.4/67.6
C3753	4030006880	S.CER C1608 JB 1H 472K-T	B	133.4/68.9
C3754	4030006880	S.CER C1608 JB 1H 472K-T	B	132.6/70.2
C3755	4030006880	S.CER C1608 JB 1H 472K-T	B	131.6/71.5
C3756	4030006880	S.CER C1608 JB 1H 472K-T	B	132.1/72.8
C3757	4030006880	S.CER C1608 JB 1H 472K-T	B	131.6/74.1
C3758	4030006880	S.CER C1608 JB 1H 472K-T	B	132.1/75.4
C3761	4030006880	S.CER C1608 JB 1H 472K-T	B	131.6/76.7
C3762	4030006880	S.CER C1608 JB 1H 472K-T	B	132.1/78
C3763	4030006880	S.CER C1608 JB 1H 472K-T	B	131.6/79.3
C3764	4030006880	S.CER C1608 JB 1H 472K-T	B	132.1/80.6
C3765	4030006880	S.CER C1608 JB 1H 472K-T	B	132.6/81.9
C3766	4030006880	S.CER C1608 JB 1H 472K-T	B	133.1/83.2
C3767	4030006880	S.CER C1608 JB 1H 472K-T	B	132.1/84.5
C3768	4030006880	S.CER C1608 JB 1H 472K-T	B	131.6/85.8
C3769	4030006880	S.CER C1608 JB 1H 472K-T	T	161.1/125.4
C3770	4030006880	S.CER C1608 JB 1H 472K-T	T	149.9/125.5
C3771	4030011600	S.CER C1608 JB 1E 104K-T	T	73.8/21.8
C3772	4030011600	S.CER C1608 JB 1E 104K-T	T	137.7/69.6
C3773	4030011600	S.CER C1608 JB 1E 104K-T	T	134/85.2
C3774	4030011600	S.CER C1608 JB 1E 104K-T	T	101.7/45.8
C3775	4510006670	S.ELE ECEV1CA471P	T	144.7/120.1
C3801	4030007090	S.CER C1608 CH 1H 470J-T	B	82.2/11.9
C3802	4030007090	S.CER C1608 CH 1H 470J-T	B	84.3/9.4
C3803	4030007090	S.CER C1608 CH 1H 470J-T	T	84.4/17.2
RL351	6330001320	RLY AHY103	T	8.8/100.5
RL691	6330000540	RLY OMR-109F	T	14.5/136.8
CP213	6910009670	S.CHK HK3-S-T	T	53.1/109.6
CP243	6910009670	S.CHK HK3-S-T	T	42.9/78.4
CP271	6910009670	S.CHK HK3-S-T	T	32/51.4
CP501	6910009670	S.CHK HK3-S-T	T	83.5/26.3
J101	6510007020	CNR TMP-J01X-V6	T	49.3/7.2
J201	6910012460	CNR IMSA-9180S-30A	T	67.9/67.6
J202	6910012460	CNR IMSA-9180S-30A	T	174.5/122
J211	6510007020	CNR TMP-J01X-V6	T	38.5/102.1
J351	6450000140	CNR HSJ0807-01-010	T	5.5/93.5
J641	6510018970	S.CNR B4B-PH-SM3-TB	T	15.6/84.5
J661	6510023670	CNR TCS4480-01-4151	T	11.5/20.5
J662	6510023660	CNR TCS4470-01-4151	T	11.5/44.5
J681	6450001490	CNR HLJ7001-01-3010	T	8/64.5
J691	6450001130	CNR JPJ2042-01-1190	T	3/127.5
J701	6450000140	CNR HSJ0807-01-010	T	5.5/79.5
J741	6510022590	S.CNR 22FMN-BMTTR-A-TBT	T	121.

[MAIN-A UNIT]

REF NO.	ORDER NO.	DESCRIPTION	M.	H/V LOCATION
J891	6510022580	S.CNR 24FMN-BMTTR-A-TBT	T	191.7/60.5
J1702	6510022620	S.CNR 10FMN-BMTTR-A-TBT	T	190/134
J3501	6510021860	CNR BH-800.8 <LTC>	T	46/128.5
J3502	6510019190	S.CNR 52365-0891	T	104.6/49
J3503	6510022060	S.CNR AXK5S30235P	T	190/26
J3504	6510022060	S.CNR AXK5S30235P	T	150/26
BT3501	3020000110	LTM CR2032		
W122	7030003860	S.RES ERJ3GE JPW V	B	53/87.3
W151	7030000010	S.RES MCR10EZHZ JPW (000)	T	58.5/81.5
W252	7030003860	S.RES ERJ3GE JPW V	T	46.4/86.8
W278	7030003860	S.RES ERJ3GE JPW V	T	29.3/34.4
W291	7030003860	S.RES ERJ3GE JPW V	T	48/37.5
W308	7030003860	S.RES ERJ3GE JPW V	T	96.8/119
W309	7030003860	S.RES ERJ3GE JPW V	T	96.8/117
W311	7030003860	S.RES ERJ3GE JPW V	T	94.7/110.9
W319	7030003860	S.RES ERJ3GE JPW V	B	78.5/113
W354	7030003860	S.RES ERJ3GE JPW V	B	22/100.2
W355	7030003860	S.RES ERJ3GE JPW V	B	69.9/86.4
W451	7030003860	S.RES ERJ3GE JPW V	T	138.2/116.5
W452	7030008240	S.RES ERJ12YJ0R00U	T	102/100.3
W501	7030003860	S.RES ERJ3GE JPW V	B	83.7/56.2
W503	7030003860	S.RES ERJ3GE JPW V	T	78.5/41.3
W561	7030003860	S.RES ERJ3GE JPW V	B	97.8/29
W571	7030003860	S.RES ERJ3GE JPW V	T	92.2/36
W572	7030003860	S.RES ERJ3GE JPW V	B	89.3/32.8
W701	7030003860	S.RES ERJ3GE JPW V	B	15.9/81
W702	7030003860	S.RES ERJ3GE JPW V	T	133.2/24.4
W703	7030003860	S.RES ERJ3GE JPW V	T	115.7/19.6
W854	7030000010	S.RES MCR10EZHZ JPW (000)	T	186.5/55.8
W1001	7030009300	S.RES ERJ1WY0R00U	B	59.2/112.5
W3001	7030003860	S.RES ERJ3GE JPW V	T	84.2/61.5
W3010	7030003860	S.RES ERJ3GE JPW V	T	99.1/67.4
W3014	7030003860	S.RES ERJ3GE JPW V	T	91.5/80.1
W3504	7030003860	S.RES ERJ3GE JPW V	T	146.7/139.3
W3551	7030003860	S.RES ERJ3GE JPW V	T	174.1/73.2
W3562	7030008240	S.RES ERJ12YJ0R00U	T	181.2/87
W3563	7030000010	S.RES MCR10EZHZ JPW (000)	T	185.9/87.9
W3564	7030003860	S.RES ERJ3GE JPW V	T	197.7/75.8
W3565	7030003860	S.RES ERJ3GE JPW V	T	182.5/74.9
W3601	7030003860	S.RES ERJ3GE JPW V	T	129.8/139.3
W3730	7030003860	S.RES ERJ3GE JPW V	T	71.1/73.1
EP1	0910054305	PCB B 5705E		
EP631	6910012350	S.BEA MMZ1608Y 102BT	B	25/96.6
EP632	6910012350	S.BEA MMZ1608Y 102BT	B	21.2/88.3
EP633	6910012350	S.BEA MMZ1608Y 102BT	B	17.1/82.8
EP634	6910012350	S.BEA MMZ1608Y 102BT	B	25/95.3
EP658	6910012350	S.BEA MMZ1608Y 102BT	B	23.4/22.2
EP681	6910012350	S.BEA MMZ1608Y 102BT	B	8/62.5
EP682	6910012350	S.BEA MMZ1608Y 102BT	B	27.9/71.4
EP691	6910012350	S.BEA MMZ1608Y 102BT	B	3.8/115
EP692	6910012350	S.BEA MMZ1608Y 102BT	B	8.3/116.8
EP701	6910012350	S.BEA MMZ1608Y 102BT	B	2.3/82.4
EP702	6910012350	S.BEA MMZ1608Y 102BT	B	7.3/82.4
EP703	6910012350	S.BEA MMZ1608Y 102BT	T	68.8/2.2
EP861	6910012350	S.BEA MMZ1608Y 102BT	T	29.6/110.5
EP3621	6910012350	S.BEA MMZ1608Y 102BT	T	137.7/68
EP3622	6910012350	S.BEA MMZ1608Y 102BT	T	135.7/63.5

M.=Mounted side (T: Mounted on the Top side, B: Mounted on the Bottom side)

[DSP-A UNIT]

REF NO.	ORDER NO.	DESCRIPTION	M.	H/V LOCATION
IC2001	1190000970	S.IC ADSP-21061LKS-160	T	33.3/91.3
IC2041	1130008360	S.IC TC7SHU04FU (TE85L)	T	5.4/103.8
IC2042	1130008040	S.IC TC7SH04FU	T	11.9/103.8
IC2051	1130009310	S.IC TC74VHC125FT (EL)	T	65.9/109.8
IC2052	1130009300	S.IC TC7SET08FU (TE85L)	T	63.9/119.7
IC2053	1130006080	S.IC TC74HC02AF (TP1)	T	77.1/110.6
IC2054	1130009620	S.IC TC74VHC74FT (EL)	T	79.4/119.6
IC2061	1130009300	S.IC TC7SET08FU (TE85L)	T	64.3/116
IC2062	1130009290	S.IC TC74VHC541FT (EL)	T	58.3/107.8
IC2063	1130009300	S.IC TC7SET08FU (TE85L)	T	71.6/115.3
IC2065	1130009300	S.IC TC7SET08FU (TE85L)	T	62.4/99
IC2066	1130009300	S.IC TC7SET08FU (TE85L)	T	57.2/99
IC2071	1130012570	IC M27C4001-12F1/SC-1414	T	80.9/66.2
IC2072	1130009290	S.IC TC74VHC541FT (EL)	T	57.5/70.5
IC2091	1110005740	S.IC S-80934CNMC-G84-T2	T	60.1/114.9
IC2092	1130006540	S.IC TC7S02FU (TE85R)	T	58.4/118.7
IC2101	1130008810	S.IC TC7SH32FU (TE85L)	T	70.1/119.5
IC2201	1130008230	S.IC BU4053BCFV-E2	T	59.6/52.3
IC2211	1110005240	S.IC NJM4565M-TE1	T	57.2/36.9
IC2281	1110003870	S.IC NJM2058M-TE1	T	45.5/17.5
IC2291	1130006220	S.IC TC4W53FU (TE12L)	T	56.6/15.8
IC2301	1110005420	S.IC BA15532F-E2	T	67.2/26.1
IC2302	1130006220	S.IC TC4W53FU (TE12L)	T	43.3/40.4
IC2321	1190000960	S.IC CS5396-KS	T	73.1/46.9
IC2341	1130009610	S.IC TC74VHC00FT (EL)	T	45.2/49.3
IC2342	1130009630	S.IC TC74VHC4040FT (EL)	T	52.8/59.6
IC2343	1130009280	S.IC TC7WH74FU (TE12L)	T	50.9/50.2
IC2344	1130009620	S.IC TC74VHC74FT (EL)	T	59.7/61.5
IC2345	1130008810	S.IC TC7SH32FU (TE85L)	T	40.3/51
IC2346	1130009300	S.IC TC7SET08FU (TE85L)	T	39.7/45.9
IC2347	1130007131	S.IC TC74HC390AF (EL)	T	44/59.5
IC2348	1130009300	S.IC TC7SET08FU (TE85L)	T	51/111.8
IC2351	1190002090	S.IC AD1854JRSZRL	T	29.8/57.9
IC2352	1130008360	S.IC TC7SHU04FU (TE85L)	T	32.9/67.5
IC2353	1130008040	S.IC TC7SH04FU	T	33.1/63.7
IC2371	1110001900	S.IC μPC4570G2-T1	T	28/43.6
IC2372	1130008230	S.IC BU4053BCFV-E2	T	19.2/49.2
IC2381	1110005060	S.IC μPC4574G2-E1	T	13.5/18.8
IC2401	1190001100	S.IC MAX293CWE-W	T	9/54.3
IC2441	1110003870	S.IC NJM2058M-TE1	T	29.9/18.8
IC2461	1110004770	S.IC BU9480F-E2	T	6.3/26
IC2471	1110005240	S.IC NJM4565M-TE1	T	17.4/7.5
IC2472	1110005240	S.IC NJM4565M-TE1	T	11.9/36.2
IC2473	1130006220	S.IC TC4W53FU (TE12L)	T	25.5/31.2
IC2474	1130008040	S.IC TC7SH04FU	T	10/98.6
IC2475	1130009300	S.IC TC7SET08FU (TE85L)	T	10/94.6
Q2201	1590003280	S.TR UNR9211J-(TX)	T	63.6/40
Q2202	1590003280	S.TR UNR9211J-(TX)	T	63.9/37.7
Q2211	1590003280	S.TR UNR9211J-(TX)	T	60.1/33
Q2213	1590003280	S.TR UNR9211J-(TX)	T	28/7
Q2321	1590002470	S.FET 2SJ381-TD	T	73.4/58.7
Q2322	1590002470	S.FET 2SJ381-TD	T	66/15.1
D2371	1730002320	S.ZEN MA8051-M (TX)	T	33.9/37.9
D2372	1730002320	S.ZEN MA8051-M (TX)	T	32.6/45.5
D2373	1790001250	S.DIO MA2S111-(TX)	T	16.7/44.1
X2041	6050009880	S.XTL CR-568 (40.000 MHz)	T	8.1/109.1
X2351	6050010650	S.XTL CR-643 (24.576 MHz)	T	23.2/67.5
L2001	6190001190	S.COL D10F-A814AY-101K=P3	T	6.5/86.7
L2401	6200003260	S.COL NL 322522T-101J	T	4.8/36
L2402	6200003260	S.COL NL 322522T-101J	T	4.8/40.2
L2461	6200003260	S.COL NL 322522T-101J	T	11.2/5
L2502	6200003950	S.COL HF50ACC 322513-T	T	52.7/10.5
L2503	6200003950	S.COL HF50ACC 322513-T	T	63.7/11
L2504	6200003950	S.COL HF50ACC 322513-T	T	72.4/14.9
L2506	6200003950	S.COL HF50ACC 322513-T	T	72.4/11.2
R2001	7030003560	S.RES ERJ3GEYJ 103 V (10 kΩ)	T	51.7/104.1
R2002	7030003560	S.RES ERJ3GEYJ 103 V (10 kΩ)	T	45.6/111
R2003	7030003560	S.RES ERJ3GEYJ 103 V (10 kΩ)	T	44.3/111
R2004	7030003560	S.RES ERJ3GEYJ 103 V (10 kΩ)	T	43/111
R2005	7030003560	S.RES ERJ3GEYJ 103 V (10 kΩ)	T	41.7/111
R2006	7030003560	S.RES ERJ3GEYJ 103 V (10 kΩ)	T	33/110.6
R2007	7030003560	S.RES ERJ3GEYJ 103 V (10 kΩ)	T	31.7/110.6
R2008	7030003560	S.RES ERJ3GEYJ 103 V (10 kΩ)	T	29.5/110.6
R2009	7030003560	S.RES ERJ3GEYJ 103 V (10 kΩ)	T	28.2/111.2
R2010	7030003560	S.RES ERJ3GEYJ 103 V (10 kΩ)	T	26.9/111.2
R2011	7030003560	S.RES ERJ3GEYJ 103 V (10 kΩ)	T	25.6/111.2
R2012	7030003560	S.RES ERJ3GEYJ 103 V (10 kΩ)	T	24.3/111.2
R2013	7030003560	S.RES ERJ3GEYJ 103 V (10 kΩ)	T	23/111.2
R2014	7030003560	S.RES ERJ3GEYJ 103 V (10 kΩ)	T	41.1/70.5
R2015	7030003560	S.RES ERJ3GEYJ 103 V (10 kΩ)	T	42.4/70.5
R2016	7030003560	S.RES ERJ3GEYJ 103 V (10 kΩ)	T	43.7/70.5
R2017	7030003560	S.RES ERJ3GEYJ 103 V (10 kΩ)	T	45/70.5
R2018	7030003560	S.RES ERJ3GEYJ 103 V (10 kΩ)	T	46.3/70.5

S.=Surface mount

[DSP-A UNIT]

REF NO.	ORDER NO.	DESCRIPTION	M.	H/V LOCATION
R2019	7030003560	S.RES ERJ3GEYJ 103 V (10 kΩ)	T	47.6/70.5
R2020	7030003560	S.RES ERJ3GEYJ 103 V (10 kΩ)	T	39.8/70.5
R2041	7030003800	S.RES ERJ3GEYJ 105 V (1 MΩ)	T	7.9/105.7
R2042	7030003320	S.RES ERJ3GEYJ 101 V (100 Ω)	T	3.8/105.7
R2043	7030003320	S.RES ERJ3GEYJ 101 V (100 Ω)	T	10.6/105.7
R2051	7030003320	S.RES ERJ3GEYJ 101 V (100 Ω)	T	70.1/107.8
R2052	7030003320	S.RES ERJ3GEYJ 101 V (100 Ω)	T	62.5/122
R2053	7030003320	S.RES ERJ3GEYJ 101 V (100 Ω)	T	74.5/118.2
R2054	7030003320	S.RES ERJ3GEYJ 101 V (100 Ω)	T	74.7/121.1
R2062	7030003640	S.RES ERJ3GEYJ 473 V (47 kΩ)	T	56.5/114.6
R2063	7030003320	S.RES ERJ3GEYJ 101 V (100 Ω)	T	67.7/116.2
R2064	7030003320	S.RES ERJ3GEYJ 101 V (100 Ω)	T	62.5/105.3
R2065	7030003320	S.RES ERJ3GEYJ 101 V (100 Ω)	T	59.6/100.9
R2066	7030003320	S.RES ERJ3GEYJ 101 V (100 Ω)	T	55.9/100.9
R2067	7030003640	S.RES ERJ3GEYJ 473 V (47 kΩ)	T	61.6/112.1
R2068	7030003640	S.RES ERJ3GEYJ 473 V (47 kΩ)	T	58.8/112.6
R2071	7030003320	S.RES ERJ3GEYJ 101 V (100 Ω)	T	72.6/63.2
R2072	7030003560	S.RES ERJ3GEYJ 103 V (10 kΩ)	T	60.6/66.3
R2073	7030003560	S.RES ERJ3GEYJ 103 V (10 kΩ)	T	53.9/66.5
R2074	7030003320	S.RES ERJ3GEYJ 101 V (100 Ω)	T	51.1/66.5
R2083	7030003320	S.RES ERJ3GEYJ 101 V (100 Ω)	T	70.1/117.3
R2091	7030003560	S.RES ERJ3GEYJ 103 V (10 kΩ)	T	56/119.3
R2092	7030003320	S.RES ERJ3GEYJ 101 V (100 Ω)	T	58.5/120.8
R2101	7030003680	S.RES ERJ3GEYJ 104 V (100 kΩ)	T	67.8/121.8
R2102	7030003320	S.RES ERJ3GEYJ 101 V (100 Ω)	T	70.4/121.8
R2201	7030003680	S.RES ERJ3GEYJ 104 V (100 kΩ)	T	62.1/47.1
R2202	7030003320	S.RES ERJ3GEYJ 101 V (100 Ω)	T	63.6/49.8
R2203	7030003320	S.RES ERJ3GEYJ 101 V (100 Ω)	T	56/48.7
R2211	7030003680	S.RES ERJ3GEYJ 104 V (100 kΩ)	T	59.3/47.8
R2212	7030003640	S.RES ERJ3GEYJ 473 V (47 kΩ)	T	57/40.3
R2213	7030005451	S.RES ERA3YED 153V	T	57/41.6
R2214	7030006101	S.RES ERA3YED 183V	T	60/41.6
R2215	7030003370	S.RES ERJ3GEYJ 271 V (270 Ω)	T	63.1/34.7
R2216	7030003460	S.RES ERJ3GEYJ 152 V (1.5 kΩ)	T	61.8/37.4
R2217	7030003760	S.RES ERJ3GEYJ 474 V (470 kΩ)	T	61.8/34.7
R2218	7030003320	S.RES ERJ3GEYJ 101 V (100 Ω)	T	51.6/33.4
R2219	7030003750	S.RES ERJ3GEYJ 394 V (390 kΩ)	T	53.5/40.7
R2220	7030003760	S.RES ERJ3GEYJ 474 V (470 kΩ)	T	51.4/42.5
R2221	7030003700	S.RES ERJ3GEYJ 154 V (150 kΩ)	T	54.1/42.9
R2222	7030003670	S.RES ERJ3GEYJ 823 V (82 kΩ)	T	51.6/39.9
R2223	7030003670	S.RES ERJ3GEYJ 823 V (82 kΩ)	T	51.6/37.3
R2224	7030003760	S.RES ERJ3GEYJ 474 V (470 kΩ)	T	57.6/33.4
R2227	7310002720	S.TRI RV-148 (RH03A3AS3X0DA) 472	T	38.7/31.8
R2229	7310002720	S.TRI RV-148 (RH03A3AS3X0DA) 472	T	44.8/30.7
R2230	7030003430	S.RES ERJ3GEYJ 821 V (820 Ω)	T	58.2/43
R2241	7030005321	S.RES ERA3YED 103V	T	40.1/15.1
R2242	7030003720	S.RES ERJ3GEYJ 224 V (220 kΩ)	T	43.2/11.6
R2243	7030005321	S.RES ERA3YED 103V	T	40.1/16.4
R2244	7030008061	S.RES ERA3YED 222V	T	40.1/13.8
R2245	7030007230	S.RES ERA3YED 102V	T	40.1/12.5
R2252	7030006561	S.RES ERA3YED 223V	T	53.3/27.2
R2253	7030006561	S.RES ERA3YED 223V	T	55.5/23.3
R2254	7030006561	S.RES ERA3YED 223V	T	53.6/25.9
R2255	7030006561	S.RES ERA3YED 223V	T	52.5/19.2
R2256	7030006561	S.RES ERA3YED 223V	T	52/17.3
R2257	7030003440	S.RES ERJ3GEYJ 102 V (1 kΩ)	T	63.9/42.5
R2281	7030003320	S.RES ERJ3GEYJ 101 V (100 Ω)	T	32.3/31.3
R2282	7030003320	S.RES ERJ3GEYJ 101 V (100 Ω)	T	41.1/29
R2283	7030003560	S.RES ERJ3GEYJ 103 V (10 kΩ)	T	55.2/19.2
R2291	7030003320	S.RES ERJ3GEYJ 101 V (100 Ω)	T	59.6/14.4
R2292	7030003320	S.RES ERJ3GEYJ 101 V (100 Ω)	T	59.6/17
R2293	7030003680	S.RES ERJ3GEYJ 104 V (100 kΩ)	T	57.2/20.3
R2294	7030003560	S.RES ERJ3GEYJ 103 V (10 kΩ)	T	49.6/12.5
R2302	7030003560	S.RES ERJ3GEYJ 103 V (10 kΩ)	T	64.2/21.1
R2304	7030003560	S.RES ERJ3GEYJ 103 V (10 kΩ)	T	67/19.6
R2306	7030005321	S.RES ERA3YED 103V	T	68.5/31
R2307	7030003320	S.RES ERJ3GEYJ 101 V (100 Ω)	T	69.3/20.7
R2308	7030005321	S.RES ERA3YED 103V	T	65.8/31
R2309	7030003320	S.RES ERJ3GEYJ 101 V (100 Ω)	T	61.7/31.5
R2321	7030009691	S.RES ERA3YED 101V (100 Ω)	T	72/25.7
R2322	7030009691	S.RES ERA3YED 101V (100 Ω)	T	72/27.5
R2323	7030009781	S.RES ERA3YHD 680V	T	65.3/40.5
R2324	7030009781	S.RES ERA3YHD 680V	T	65.8/42.4
R2325	7030004040	S.RES ERJ3GEYJ 4R7 V (4.7 Ω)	T	65.9/45
R2326	7030003560	S.RES ERJ3GEYJ 103 V (10 kΩ)	T	67.3/11.8
R2327	7030003480	S.RES ERJ3GEYJ 222 V (2.2 kΩ)	T	66.7/50.5
R2328	7030003560	S.RES ERJ3GEYJ 103 V (10 kΩ)	T	80.9/52
R2329	7030009891	S.RES ERA3YED 151V	T	75.2/26.6
R2340	7030003290	S.RES ERJ3GEYJ 560 V (56 Ω)	T	46.5/53.7
R2341	7030003320	S.RES ERJ3GEYJ 101 V (100 Ω)	T	49.2/46.9
R2342	7030003320	S.RES ERJ3GEYJ 101 V (100 Ω)	T	40.2/49.1
R2343	7030003320	S.RES ERJ3GEYJ 101 V (100 Ω)	T	40.2/54.2
R2344	7030003320	S.RES ERJ3GEYJ 101 V (100 Ω)	T	63.1/62.8
R2345	7030003320	S.RES ERJ3GEYJ 101 V (100 Ω)	T	55.2/54.9
R2346	7030003320	S.RES ERJ3GEYJ 101 V (100 Ω)	T	53.3/48
R2347	7030003320	S.RES ERJ3GEYJ 101 V (100 Ω)	T	73.8/60.9
R2348	7030003320	S.RES ERJ3GEYJ 101 V (100 Ω)	T	53.8/113.7
R2349	7030003290	S.RES ERJ3GEYJ 560 V (56 Ω)	T	51.9/109.3
R2350	7030008071	S.RES ERA3YED 273V	T	27.5/39.1
R2351	7030005321	S.RES ERA3YED 103V	T	26.7/37.2
R2353	7030003800	S.RES ERJ3GEYJ 105 V (1 MΩ)	T	30.9/68.8
R2354	7030003320	S.RES ERJ3GEYJ 101 V (100 Ω)	T	35.1/63.4
R2355	7030008061	S.RES ERA3YED 222V	T	28.9/51.9

M.=Mounted side (T: Mounted on the Top side, B: Mounted on the Bottom side)

[DSP-A UNIT]

REF NO.	ORDER NO.	DESCRIPTION	M.	H/V LOCATION
R2356	7030008061	S.RES ERA3YED 222V	T	29.7/50
R2357	7030008061	S.RES ERA3YED 222V	T	27.8/50
R2358	7030008061	S.RES ERA3YED 222V	T	26.5/51.6
R2359	7030008061	S.RES ERA3YED 222V	T	24.6/49.4
R2360	7030008061	S.RES ERA3YED 222V	T	26.5/48.9
R2361	7030003360	S.RES ERJ3GEYJ 221 V (220 Ω)	T	43.9/44.6
R2362	7030003360	S.RES ERJ3GEYJ 221 V (220 Ω)	T	57.9/65.9
R2363	7030003360	S.RES ERJ3GEYJ 221 V (220 Ω)	T	57.1/57.1
R2364	7030003360	S.RES ERJ3GEYJ 221 V (220 Ω)	T	38.2/48.5
R2365	7030003290	S.RES ERJ3GEYJ 560 V (56 Ω)	T	47.8/44.6
R2366	7030003320	S.RES ERJ3GEYJ 101 V (100 Ω)	T	30.9/66.3
R2369	7030003680	S.RES ERJ3GEYJ 104 V (100 kΩ)	T	21.7/53.8
R2370	7030003680	S.RES ERJ3GEYJ 104 V (100 kΩ)	T	19/53.8
R2371	7030006091	S.RES ERA3YED 822V	T	24.5/42
R2372	7030003360	S.RES ERJ3GEYJ 221 V (220 Ω)	T	35.9/50.1
R2373	7030003360	S.RES ERJ3GEYJ 221 V (220 Ω)	T	33.1/35.6
R2374	7030003320	S.RES ERJ3GEYJ 101 V (100 Ω)	T	15.4/54.6
R2375	7030003680	S.RES ERJ3GEYJ 104 V (100 kΩ)	T	22.7/50.9
R2376	7030003510	S.RES ERJ3GEYJ 392 V (3.9 kΩ)	T	24.9/28.9
R2377	7030003460	S.RES ERJ3GEYJ 152 V (1.5 kΩ)	T	28.6/26.3
R2378	7030003680	S.RES ERJ3GEYJ 104 V (100 kΩ)	T	21.4/33.3
R2379	7030008071	S.RES ERA3YED 273V	T	25.4/25.7
R2380	7030003320	S.RES ERJ3GEYJ 101 V (100 Ω)	T	22.7/44.3
R2381	7030003680	S.RES ERJ3GEYJ 104 V (100 kΩ)	T	21.6/20.4
R2382	7030003440	S.RES ERJ3GEYJ 102 V (1 kΩ)	T	21.6/19.1
R2383	7030003440	S.RES ERJ3GEYJ 102 V (1 kΩ)	T	21.6/13.7
R2384	7030003440	S.RES ERJ3GEYJ 102 V (1 kΩ)	T	18.9/17.6
R2385	7030003440	S.RES ERJ3GEYJ 102 V (1 kΩ)	T	18.8/12.3
R2386	7030003440	S.RES ERJ3GEYJ 102 V (1 kΩ)	T	18.8/13.7
R2387	7030005321	S.RES ERA3YED 103V	T	13.4/12.3
R2388	7030005321	S.RES ERA3YED 103V	T	8.8/14.8
R2389	7030009591	S.RES ERA3YED 472V	T	7.4/14.8
R2390	7030003320	S.RES ERJ3GEYJ 101 V (100 Ω)	T	18.9/23.2
R2391	7030003320	S.RES ERJ3GEYJ 101 V (100 Ω)	T	11.4/25.2
R2392	7030003680	S.RES ERJ3GEYJ 104 V (100 kΩ)	T	22.4/22.3
R2394	7030003680	S.RES ERJ3GEYJ 104 V (100 kΩ)	T	18.1/44.4
R2402	7030005451	S.RES ERA3YED 153V	T	5.2/60.8
R2403	7030005451	S.RES ERA3YED 153V	T	7.8/62.2
R2404	7030006561	S.RES ERA3YED 223V	T	7.8/63.5
R2421	7030003320	S.RES ERJ3GEYJ 101 V (100 Ω)	T	47.9/39.7
R2422	7030003400	S.RES ERJ3GEYJ 471 V (470 Ω)	T	41.8/42.8
R2423	7030003320	S.RES ERJ3GEYJ 101 V (100 Ω)	T	39.7/38.9
R2424	7030003680	S.RES ERJ3GEYJ 104 V (100 kΩ)	T	38.8/41.4
R2441	7030003520	S.RES ERJ3GEYJ 472 V (4.7 kΩ)	T	40.1/19.9
R2442	7030003560	S.RES ERJ3GEYJ 103 V (10 kΩ)	T	38.2/23.1
R2443	7030003560	S.RES ERJ3GEYJ 103 V (10 kΩ)	T	27.1/11.6
R2444	7030003560	S.RES ERJ3GEYJ 103 V (10 kΩ)	T	27.1/12.9
R2445	7030003560	S.RES ERJ3GEYJ 103 V (10 kΩ)	T	32.6/11.6
R2446	7030003560	S.RES ERJ3GEYJ 103 V (10 kΩ)	T	35.3/12.9
R2447	7030003560	S.RES ERJ3GEYJ 103 V (10 kΩ)	T	35.3/20.7
R2448	7030003560	S.RES ERJ3GEYJ 103 V (10 kΩ)	T	35.3/22
R2449	7030003560	S.RES ERJ3GEYJ 103 V (10 kΩ)	T	35.3/19.4
R2450	7030003440	S.RES ERJ3GEYJ 102 V (1 kΩ)	T	25.5/3.9
R2451	7030003320	S.RES ERJ3GEYJ 101 V (100 Ω)	T	48.7/23.4
R2452	7030003320	S.RES ERJ3GEYJ 101 V (100 Ω)	T	39.7/20.9
R2453	7030003540	S.RES ERJ3GEYJ 682 V (6.8 kΩ)	T	35.3/23.3
R2472	7030003680	S.RES ERJ3GEYJ 104 V (100 kΩ)	T	11.2/7.7
R2474	7030003680	S.RES ERJ3GEYJ 104 V (100 kΩ)	T	11.2/9.1
R2475	7030003600	S.RES ERJ3GEYJ 223 V (22 kΩ)	T	10.6/11
R2476	7030003500	S.RES ERJ3GEYJ 223 V (3.3 kΩ)	T	7.9/12.3
R2477	7030003320	S.RES ERJ3GEYJ 101 V (100 Ω)	T	23.1/10.8
R2478	7030003320	S.RES ERJ3GEYJ 101 V (100 Ω)	T	14.3/4.1
R2479	7030003560	S.RES ERJ3GEYJ 103 V (10 kΩ)	T	22/6.3
R2480	7030003600	S.RES ERJ3GEYJ 223 V (22 kΩ)	T	22.8/9.5
R2481	7030003500	S.RES ERJ3GEYJ 332 V (3.3 kΩ)	T	26.8/10.3
R2482	7030003440	S.RES ERJ3GEYJ 102 V (1 kΩ)	T	25.6/7
R2483	7030003470	S.RES ERJ3GEYJ 182 V (1.8 kΩ)	T	22.8/8.2
R2484	7030003320	S.RES ERJ3GEYJ 101 V (100 Ω)	T	21.4/32
R2485	7030003320	S.RES ERJ3GEYJ 101 V (100 Ω)	T	26.3/34.9
R2486	7030003320	S.RES ERJ3GEYJ 101 V (100 Ω)	T	10/96.6
R2503	7030003320	S.RES ERJ3GEYJ 101 V (100 Ω)	T	51.6/120.4
R2505	7030003320	S.RES ERJ3GEYJ 101 V (100 Ω)	T	51.6/119.1
R2507	7030003320	S.RES ERJ3GEYJ 101 V (100 Ω)	T	51.6/117.8
R2509	7030003320	S.RES ERJ3GEYJ 101 V (100 Ω)	T	51.7/116.5
R2510	7030003320	S.RES ERJ3GEYJ 101 V (100 Ω)	T	46.2/114.6
R2511	7030003320	S.RES ERJ3GEYJ 101 V (100 Ω)	T	51.6/121.7
R2512	7030003320	S.RES ERJ3GEYJ 101 V (100 Ω)	T	43.3/114.6
R2513	7030003320	S.RES ERJ3GEYJ 101 V (100 Ω)	T	51.7/115.2
R2514	7030003320	S.RES ERJ3GEYJ 101 V (100 Ω)	T	40.6/114.6
R2515	7030003320	S.RES ERJ3GEYJ 101 V (100 Ω)	T	35.3/122
R2516	7030003320	S.RES ERJ3GEYJ 101 V (100 Ω)	T	37.9/114.6
R2517	7030003320	S.RES ERJ3GEYJ 101 V (100 Ω)	T	31.3/122
R2518	7030003320	S.RES ERJ3GEYJ 101 V (100 Ω)	T	3

[DSP-A UNIT]

REF NO.	ORDER NO.	DESCRIPTION	M.	H/V LOCATION
R2578	7030003760	S.RES ERJ3GEYJ 474 V (470 kΩ)	T	16.1/41.2
R2579	7030003760	S.RES ERJ3GEYJ 474 V (470 kΩ)	T	19.4/40.8
R2580	7030003760	S.RES ERJ3GEYJ 474 V (470 kΩ)	T	16.5/32.1
R2581	7030003680	S.RES ERJ3GEYJ 104 V (100 kΩ)	T	17.8/34.8
R2582	7030003680	S.RES ERJ3GEYJ 104 V (100 kΩ)	T	16.5/37.4
R2583	7030003680	S.RES ERJ3GEYJ 104 V (100 kΩ)	T	17.8/37.4
C2001	4030011600	S.CER C1608 JB 1E 104K-T	T	52.6/77.3
C2002	4030011600	S.CER C1608 JB 1E 104K-T	T	52.9/81.8
C2003	4030011600	S.CER C1608 JB 1E 104K-T	T	54/87.4
C2004	4030011600	S.CER C1608 JB 1E 104K-T	T	53.4/91.5
C2005	4030011600	S.CER C1608 JB 1E 104K-T	T	52.5/95.1
C2006	4030011600	S.CER C1608 JB 1E 104K-T	T	52.5/96.4
C2007	4030011600	S.CER C1608 JB 1E 104K-T	T	51.8/98.3
C2008	4030011600	S.CER C1608 JB 1E 104K-T	T	51.7/101.5
C2009	4030011600	S.CER C1608 JB 1E 104K-T	T	47.6/109.7
C2010	4030011600	S.CER C1608 JB 1E 104K-T	T	47.6/111
C2011	4030011600	S.CER C1608 JB 1E 104K-T	T	39.5/110.6
C2012	4030011600	S.CER C1608 JB 1E 104K-T	T	35.1/109.8
C2013	4030011600	S.CER C1608 JB 1E 104K-T	T	35.1/111.1
C2014	4030011600	S.CER C1608 JB 1E 104K-T	T	21.7/110.7
C2015	4030011600	S.CER C1608 JB 1E 104K-T	T	20.4/110.7
C2016	4030011600	S.CER C1608 JB 1E 104K-T	T	19.1/110.7
C2017	4030011600	S.CER C1608 JB 1E 104K-T	T	14.2/104.6
C2018	4030011600	S.CER C1608 JB 1E 104K-T	T	14.2/101.9
C2019	4030011600	S.CER C1608 JB 1E 104K-T	T	14.2/99.2
C2020	4030011600	S.CER C1608 JB 1E 104K-T	T	14.2/96.5
C2021	4030011600	S.CER C1608 JB 1E 104K-T	T	14.2/93.8
C2022	4030011600	S.CER C1608 JB 1E 104K-T	T	14.8/85.6
C2023	4030011600	S.CER C1608 JB 1E 104K-T	T	14.8/83
C2024	4030011600	S.CER C1608 JB 1E 104K-T	T	14.8/80.3
C2025	4030011600	S.CER C1608 JB 1E 104K-T	T	14.8/77.7
C2026	4510006220	S.ELE ECEV1CA100SR	T	9.2/77.9
C2027	4030011600	S.CER C1608 JB 1E 104K-T	T	19.4/72.9
C2028	4030011600	S.CER C1608 JB 1E 104K-T	T	22.1/72.9
C2029	4030011600	S.CER C1608 JB 1E 104K-T	T	24.8/72.4
C2030	4030011600	S.CER C1608 JB 1E 104K-T	T	35.7/72.8
C2031	4030011600	S.CER C1608 JB 1E 104K-T	T	38.7/72.5
C2033	4030012600	S.CER C2012 JB 1A 105M-T	T	4.4/96.5
C2034	4030012600	S.CER C2012 JB 1A 105M-T	T	19/122.6
C2035	4030012600	S.CER C2012 JB 1A 105M-T	T	23.3/114.3
C2041	4030011600	S.CER C1608 JB 1E 104K-T	T	3.5/103.7
C2042	4030011600	S.CER C1608 JB 1E 104K-T	T	9.9/103.7
C2043	4030007030	S.CER C1608 CH 1H 150J-T	T	7.3/103.7
C2044	4030007030	S.CER C1608 CH 1H 150J-T	T	8.6/103.7
C2051	4030011600	S.CER C1608 JB 1E 104K-T	T	70.1/109.2
C2052	4030011600	S.CER C1608 JB 1E 104K-T	T	62/120
C2053	4030011600	S.CER C1608 JB 1E 104K-T	T	75.3/116.2
C2054	4030011600	S.CER C1608 JB 1E 104K-T	T	76/121.1
C2055	4030007090	S.CER C1608 CH 1H 470J-T	T	82.2/115
C2061	4030011600	S.CER C1608 JB 1E 104K-T	T	67.7/114.8
C2062	4030011600	S.CER C1608 JB 1E 104K-T	T	62.5/108
C2063	4030011600	S.CER C1608 JB 1E 104K-T	T	69.6/115.3
C2065	4030011600	S.CER C1608 JB 1E 104K-T	T	59.1/99.1
C2066	4030011600	S.CER C1608 JB 1E 104K-T	T	55.1/99.1
C2071	4030011600	S.CER C1608 JB 1E 104K-T	T	75.4/63.2
C2072	4030011600	S.CER C1608 JB 1E 104K-T	T	53.9/65.2
C2091	4030011600	S.CER C1608 JB 1E 104K-T	T	57.8/114.6
C2092	4030008890	S.CER C1608 JB 1H 273K-T	T	57.2/116.4
C2093	4030011600	S.CER C1608 JB 1E 104K-T	T	56.7/121.6
C2101	4030011600	S.CER C1608 JB 1E 104K-T	T	68.1/120
C2201	4030011600	S.CER C1608 JB 1E 104K-T	T	56.1/51.4
C2202	4030011600	S.CER C1608 JB 1E 104K-T	T	63.6/52.5
C2210	4550006250	S.TAN TEESVA 1A 106M8L	T	60/45.4
C2211	4030006880	S.CER C1608 JB 1H 472K-T	T	56/43.9
C2212	4030011600	S.CER C1608 JB 1E 104K-T	T	60/40.3
C2213	4030011600	S.CER C1608 JB 1E 104K-T	T	61.9/40.1
C2214	4510004630	S.ELE ECEV1CA100SR	T	56.7/30.3
C2215	4030011600	S.CER C1608 JB 1E 104K-T	T	54.3/33.4
C2216	4510004630	S.ELE ECEV1CA100SR	T	50.8/30.3
C2217	4030006860	S.CER C1608 JB 1H 102K-T	T	51.6/41.2
C2218	4030006870	S.CER C1608 JB 1H 222K-T	T	51.6/36.6
C2219	4030007170	S.CER C1608 CH 1H 221J-T	T	51.6/38.6
C2220	4510004630	S.ELE ECEV1CA100SR	T	47.2/36.1
C2255	4030006870	S.CER C1608 JB 1H 222K-T	T	56.3/25.9
C2256	4030011280	S.CER C1608 CH 1H 271J-T	T	56.3/24.6
C2257	4030008470	S.CER C1608 JB 1H 272K-T	T	53.6/24.6
C2258	4030011340	S.CER C1608 CH 1H 471J-T	T	52.8/23.3
C2259	4030009580	S.CER C1608 JB 1H 681K-T	T	50.9/24.6
C2260	4030007120	S.CER C1608 CH 1H 820J-T	T	50.9/25.9
C2261	4030006880	S.CER C1608 JB 1H 472K-T	T	52/14.6
C2262	4030010020	S.CER C1608 JB 1H 122K-T	T	50.6/14.6
C2263	4030010040	S.CER C1608 JB 1H 561K-T	T	52.5/21.1
C2281	4550000270	S.TAN TEESVA 1E 474M8L	T	53.8/15.7
C2283	4030011600	S.CER C1608 JB 1E 104K-T	T	35.3/18.1
C2284	4510004630	S.ELE ECEV1CA100SR	T	36.4/26.8
C2285	4030011600	S.CER C1608 JB 1E 104K-T	T	24.4/19.2
C2286	4510004630	S.ELE ECEV1CA100SR	T	31.6/26.9
C2291	4030011600	S.CER C1608 JB 1E 104K-T	T	59.6/15.7
C2292	4030011600	S.CER C1608 JB 1E 104K-T	T	59.6/18.3
C2293	4340000250	S.MLR ECHU 1C 104JX5	T	46.9/10.5
C2301	4510004630	S.ELE ECEV1CA100SR	T	60.2/21.8

M.=Mounted side (T: Mounted on the Top side, B: Mounted on the Bottom side)

[DSP-A UNIT]

REF NO.	ORDER NO.	DESCRIPTION	M.	H/V LOCATION
C2302	4030011600	S.CER C1608 JB 1E 104K-T	T	58.9/26.6
C2303	4510006220	S.ELE ECEV1CA101UP	T	73.7/33.3
C2306	4030011600	S.CER C1608 JB 1E 104K-T	T	72/23.9
C2307	4510004630	S.ELE ECEV1CA100SR	T	72.5/20.4
C2308	4510005890	S.ELE ECEV1AAN100R	T	62/28
C2309	4030011600	S.CER C1608 JB 1E 104K-T	T	63.6/31.9
C2310	4510004630	S.ELE ECEV1CA100SR	T	67.8/34.7
C2311	4030011810	S.CER C1608 JB 1A 224K-T	T	46.6/39.7
C2321	4030009880	S.CER C1608 JB 1H 682K-T	T	73.9/26.6
C2322	4030009880	S.CER C1608 JB 1H 682K-T	T	66.6/40.5
C2323	4030011600	S.CER C1608 JB 1E 104K-T	T	77.4/36.9
C2324	4510004630	S.ELE ECEV1CA100SR	T	79.7/33.3
C2325	4030011600	S.CER C1608 JB 1E 104K-T	T	80.1/39.4
C2327	4030011600	S.CER C1608 JB 1E 104K-T	T	79.6/52
C2328	4510006220	S.ELE ECEV1CA101UP	T	80/60.2
C2329	4030011600	S.CER C1608 JB 1E 104K-T	T	65.9/46.4
C2330	4030011600	S.CER C1608 JB 1E 104K-T	T	65.9/47.8
C2331	4510006220	S.ELE ECEV1CA101UP	T	67.3/60
C2338	4030007080	S.CER C1608 CH 1H 390J-T	T	42.8/53.7
C2340	4030006880	S.CER C1608 JB 1H 472K-T	T	63.1/57.6
C2341	4030011600	S.CER C1608 JB 1E 104K-T	T	48.6/50
C2342	4030011600	S.CER C1608 JB 1E 104K-T	T	56.3/59.2
C2343	4030011600	S.CER C1608 JB 1E 104K-T	T	53.3/50.9
C2344	4030007090	S.CER C1608 CH 1H 470J-T	T	51.4/55.1
C2345	4030011600	S.CER C1608 JB 1E 104K-T	T	51.1/113.7
C2346	4030011600	S.CER C1608 JB 1E 104K-T	T	63.1/60.2
C2347	4030011600	S.CER C1608 JB 1E 104K-T	T	40.2/47.8
C2348	4030011600	S.CER C1608 JB 1E 104K-T	T	40.2/52.9
C2349	4030011600	S.CER C1608 JB 1E 104K-T	T	37.8/63.7
C2351	4030007010	S.CER C1608 CH 1H 100D-T	T	29.6/66.3
C2352	4030007010	S.CER C1608 CH 1H 100D-T	T	29.6/68.8
C2353	4510004630	S.ELE ECEV1CA100SR	T	10.8/68.5
C2354	4030011600	S.CER C1608 JB 1E 104K-T	T	59.3/122.6
C2355	4510004630	S.ELE ECEV1CA100SR	T	16.3/67.1
C2356	4030011600	S.CER C1608 JB 1E 104K-T	T	23.8/62
C2357	4510004630	S.ELE ECEV1CA100SR	T	17/62.3
C2358	4030011600	S.CER C1608 JB 1E 104K-T	T	23.8/55.2
C2359	4510004630	S.ELE ECEV1CA100SR	T	20.8/57.5
C2360	4030011600	S.CER C1608 JB 1E 104K-T	T	34/65.6
C2361	4030011600	S.CER C1608 JB 1E 104K-T	T	34.8/67.5
C2362	4030006880	S.CER C1608 JB 1H 472K-T	T	36.4/62.3
C2363	4030006860	S.CER C1608 JB 1H 102K-T	T	24.6/52
C2364	4030007170	S.CER C1608 CH 1H 221J-T	T	29.1/48.1
C2365	4030006860	S.CER C1608 JB 1H 102K-T	T	24.6/50.7
C2366	4030007170	S.CER C1608 CH 1H 221J-T	T	24.6/48.1
C2367	4510004440	S.ELE ECEV1HA010SR	T	30/36.1
C2370	4030007080	S.CER C1608 CH 1H 390J-T	T	37.6/44.6
C2371	4030007080	S.CER C1608 CH 1H 390J-T	T	38.2/51.1
C2372	4510004630	S.ELE ECEV1CA100SR	T	32.8/49.3
C2373	4030011600	S.CER C1608 JB 1E 104K-T	T	24.5/46.2
C2374	4510004630	S.ELE ECEV1CA100SR	T	34.5/41.8
C2375	4030011600	S.CER C1608 JB 1E 104K-T	T	31.4/41.5
C2376	4030011600	S.CER C1608 JB 1E 104K-T	T	16.8/54.6
C2377	4030011600	S.CER C1608 JB 1E 104K-T	T	22.7/47.3
C2378	4030011600	S.CER C1608 JB 1E 104K-T	T	27.3/25.7
C2379	4030011600	S.CER C1608 JB 1E 104K-T	T	26.5/27.6
C2380	4030011600	S.CER C1608 JB 1E 104K-T	T	27.6/28.9
C2381	4030010020	S.CER C1608 JB 1H 122K-T	T	21.6/17.8
C2383	4030009980	S.CER C1608 JB 1H 152K-T	T	21.6/12.3
C2384	4030009000	S.CER C2012 JB 1C 224K-T	T	15.4/46.8
C2385	4030011330	S.CER C1608 CH 1H 391J-T	T	18.9/21.6
C2387	4030008470	S.CER C1608 JB 1H 272K-T	T	16.9/13.2
C2389	4030011280	S.CER C1608 CH 1H 271J-T	T	18.9/15
C2391	4510004630	S.ELE ECEV1CA100SR	T	21/26.5
C2392	4030011600	S.CER C1608 JB 1E 104K-T	T	18.9/19
C2393	4510004630	S.ELE ECEV1CA100SR	T	15.1/26.7
C2394	4030011600	S.CER C1608 JB 1E 104K-T	T	7.9/21.7
C2395	4030011810	S.CER C1608 JB 1A 224K-T	T	20.8/22.5
C2401	4030009490	S.CER C1608 JB 1H 821K-T	T	5.2/62.2
C2402	4030007150	S.CER C1608 CH 1H 151J-T	T	7.8/60.8
C2403	4510004630	S.ELE ECEV1CA100SR	T	11.7/44.7
C2404	4030011600	S.CER C1608 JB 1E 104K-T	T	9.7/61.6
C2405	4510004630	S.ELE ECEV1CA100SR	T	5.8/44.8
C2406	4030011600	S.CER C1608 JB 1E 104K-T	T	8.8/47.8
C2407	4030007130	S.CER C1608 CH 1H 101J-T	T	39.7/64.7
C2422	4030011600	S.CER C1608 JB 1E 104K-T	T	47.4/41.5
C2424	4030011600	S.CER C1608 JB 1E 104K-T	T	42.1/38
C2425	4030011810	S.CER C1608 JB 1A 224K-T	T	38.6/42.7
C2442	4030011600	S.CER C1608 JB 1E 104K-T	T	50.6/19.3
C2443	4510007570	S.ELE EEVHB1C220UR	T	46.6/26.5
C2444	4030011600	S.CER C1608 JB 1E 104K-T	T	40.1/17.7
C2445	4510007570	S.ELE EEVHB1C220UR	T	41.3/25.5
C2446	4030006880	S.CER C1608 JB 1H 472K-T	T	24.4/12.1
C2447	4030009580	S.CER C1608 JB 1H 681K-T	T	45/23.4
C2448	4030			

[DSP-A UNIT]

REF NO.	ORDER NO.	DESCRIPTION	M.	H/V LOCATION
C2463	4510004630	S.ELE ECEV1CA100SR	T	5.9/18.5
C2471	4030011600	S.CER C1608 JB 1E 104K-T	T	10.6/12.3
C2472	4030011600	S.CER C1608 JB 1E 104K-T	T	18.8/11
C2473	4030011600	S.CER C1608 JB 1E 104K-T	T	17.1/4.1
C2474	4030011600	S.CER C1608 JB 1E 104K-T	T	22.2/30.1
C2475	4030011600	S.CER C1608 JB 1E 104K-T	T	26.3/33.6
C2476	4030011600	S.CER C1608 JB 1E 104K-T	T	8.1/95
C2478	4030012600	S.CER C2012 JB 1A 105M-T	T	29.7/30.9
C2479	4030006860	S.CER C1608 JB 1H 102K-T	T	23.3/6.3
C2480	4510004630	S.ELE ECEV1CA100SR	T	20.9/36.9
C2501	4030011600	S.CER C1608 JB 1E 104K-T	T	16.7/119.9
C2502	4510004630	S.ELE ECEV1CA100SR	T	15.9/115.6
C2505	4510006220	S.ELE ECEV1CA101UP	T	39.7/7.6
C2506	4030006880	S.CER C1608 JB 1H 472K-T	T	55.3/121.6
C2507	4510006220	S.ELE ECEV1CA101UP	T	32.6/6.9
C2508	4030011600	S.CER C1608 JB 1E 104K-T	T	60.1/10.6
C2509	4510006220	S.ELE ECEV1CA101UP	T	78.7/13.5
C2510	4030011600	S.CER C1608 JB 1E 104K-T	T	15.4/57.3
C2511	4510006220	S.ELE ECEV1CA101UP	T	78.7/22.1
C2512	4030011600	S.CER C1608 JB 1E 104K-T	T	79.7/28.6
C2514	4030006860	S.CER C1608 JB 1H 102K-T	T	40.8/122.4
C2515	4030006860	S.CER C1608 JB 1H 102K-T	T	31.6/113.3
C2516	4030006880	S.CER C1608 JB 1H 472K-T	T	35.3/123.3
C2519	4030006860	S.CER C1608 JB 1H 102K-T	T	37.8/112.3
C2520	4030006860	S.CER C1608 JB 1H 102K-T	T	31.3/123.3
C2524	4030006860	S.CER C1608 JB 1H 102K-T	T	38.7/122.5
C2571	4030009000	S.CER C2012 JB 1C 224K-T	T	21.1/43.3
C2572	4030008910	S.CER C1608 JB 1H 393K-T	T	13.4/40.4
C2573	4030011600	S.CER C1608 JB 1E 104K-T	T	8/40.9
C2574	4030009980	S.CER C1608 JB 1H 152K-T	T	12.1/40.4
C2578	4030011600	S.CER C1608 JB 1E 104K-T	T	10.2/31
C2579	4510004630	S.ELE ECEV1CA100SR	T	5.8/31.7
C2580	4030011600	S.CER C1608 JB 1E 104K-T	T	13.1/31.1
C2581	4030011600	S.CER C1608 JB 1E 104K-T	T	17.8/32.1
C2582	4030007130	S.CER C1608 CH 1H 101J-T	T	16.5/34.8
J2001	6510021650	CNR IMSA-9180B-30B	B	45.4/7.9
J2002	6510021650	CNR IMSA-9180B-30B	B	47/116.8
J2003	2610000400	CNR IC140-3206-BS4		
W2072	7030003860	S.RES ERJ3GE JPW V	T	56/65.2
W2201	7030003860	S.RES ERJ3GE JPW V	T	51.6/34.7
W2202	7030003860	S.RES ERJ3GE JPW V	T	55.7/53.5
W2226	7030003860	S.RES ERJ3GE JPW V	T	42.6/33.3
W2228	7030003860	S.RES ERJ3GE JPW V	T	45.3/33.1
W2301	7030003860	S.RES ERJ3GE JPW V	T	64.2/19.6
W2302	7030003860	S.RES ERJ3GE JPW V	T	66.8/18.3
W2321	7030003860	S.RES ERJ3GE JPW V	T	80.3/47.9
W2322	7030003860	S.RES ERJ3GE JPW V	T	80.3/44.5
W2323	7030003860	S.RES ERJ3GE JPW V	T	82.2/38.6
W2324	7030003860	S.RES ERJ3GE JPW V	T	82.3/29.6
W2401	7030003860	S.RES ERJ3GE JPW V	T	42.4/64.7
W2463	7030003860	S.RES ERJ3GE JPW V	T	2.7/13.3
W2471	7030003860	S.RES ERJ3GE JPW V	T	13.4/11
W2472	7030003860	S.RES ERJ3GE JPW V	T	19.9/2.8
W2504	7030003860	S.RES ERJ3GE JPW V	T	42.2/2.9
W2505	7030003860	S.RES ERJ3GE JPW V	T	37.4/2.8
W2508	7030003860	S.RES ERJ3GE JPW V	T	19.8/113.5
W2509	7030003860	S.RES ERJ3GE JPW V	T	81.7/8.6
W2510	7030003860	S.RES ERJ3GE JPW V	T	81.7/5.7
W2511	7030003860	S.RES ERJ3GE JPW V	T	79.8/2.8
EP1	0910054272	PCB B 5704B		

M.=Mounted side (T: Mounted on the Top side, B: Mounted on the Bottom side)

[RF-B UNIT]

REF NO.	ORDER NO.	DESCRIPTION	M.	H/V LOCATION
IC201	1110006430	S.IC μPC1678GV-E1-A	T	4.1/34.4
IC301	1160000130	S.IC TD62783AF (S,EL)	B	31.5/9.9
IC302	1160000130	S.IC TD62783AF (S,EL)	B	30.5/23
IC401	1130011760	S.IC CD4094BPWR	T	40.7/10
IC402	1130011760	S.IC CD4094BPWR	T	40.6/17.8
IC403	1130011760	S.IC CD4094BPWR	T	40.6/24.7
IC1401	1110006420	S.IC μPC2708TB-E3-A	T	53.6/40
IC2001	1110003490	S.IC TA31136FN (D,EL)	T	93.2/90.4
IC2002	1110000960	S.IC NJM4558M-TE1	B	129.8/92.2
Q101	1590003280	S.TR UNR9211J-(TX)	T	34.9/86
Q102	1590002710	S.TR UMH11NTN	T	5.8/68.3
Q103	1530002060	S.TR 2SC4081 T106 R	T	34/79.9
Q104	1590001960	S.TR XP4311 (TX)	T	30.8/86.3
Q151	1590002710	S.TR UMH11NTN	T	46.8/83.2
Q152	1590003280	S.TR UNR9211J-(TX)	T	44/81.2
Q201	1510000510	S.TR 2SA1576A T106R	T	7.5/27.8
Q202	1590002710	S.TR UMH11NTN	T	8.1/32
Q203	1590003280	S.TR UNR9211J-(TX)	T	8.2/34.4
Q351	1590002710	S.TR UMH11NTN	T	26.6/28
Q352	1590002710	S.TR UMH11NTN	T	24.1/28
Q353	1590001960	S.TR XP4311 (TX)	T	23.2/31.4
Q354	1590001960	S.TR XP4311 (TX)	T	25.4/25
Q355	1590001960	S.TR XP4311 (TX)	T	25.4/22.5
Q356	1590001960	S.TR XP4311 (TX)	T	32.4/21.6
Q357	1590001960	S.TR XP4311 (TX)	T	34.9/21.6
Q1001	1560000640	S.FET 2SK1740-TA	T	72.6/26.6
Q1002	1560000640	S.FET 2SK1740-TA	T	72.6/23.5
Q1003	1560000640	S.FET 2SK1740-TA	B	92.6/27.5
Q1004	1560000640	S.FET 2SK1740-TA	T	90.1/31.9
Q1005	1560000640	S.FET 2SK1740-TA	T	90.1/24.1
Q1006	1560000640	S.FET 2SK1740-TA	B	92.6/23.4
Q1007	1530002060	S.TR 2SC4081 T106 R	T	106.8/33.2
Q1008	1530003850	S.TR 2SC5551F-TD	T	107.6/20.6
Q1101	1530003850	S.TR 2SC5551F-TD	T	81.1/19.7
Q1201	1560000640	S.FET 2SK1740-TA	T	72.3/47.4
Q1202	1560000640	S.FET 2SK1740-TA	T	72.3/44.4
Q1203	1560000640	S.FET 2SK1740-TA	B	93.1/49.9
Q1204	1560000640	S.FET 2SK1740-TA	T	89.2/51.1
Q1205	1560000640	S.FET 2SK1740-TA	T	89.2/45.5
Q1206	1560000640	S.FET 2SK1740-TA	B	93.1/46.5
Q1207	1530002060	S.TR 2SC4081 T106 R	T	103.3/58.6
Q1208	1530003850	S.TR 2SC5551F-TD	T	108.5/51.8
Q1209	1560001310	S.FET MMBFU310LT1	B	95/57.1
Q1301	1530003850	S.TR 2SC5551F-TD	T	75.5/62.4
Q1551	1560000560	S.FET 2SK882-GR (TE85L)	T	119.9/70.3
Q1751	1580000620	S.FET 3SK131-T2 MAS	T	143.2/48.9
Q1801	1560000560	S.FET 2SK882-GR (TE85L)	T	155.7/34.1
Q1901	1590001960	S.TR XP4311 (TX)	T	146/21.7
Q2101	1560000560	S.FET 2SK882-GR (TE85L)	B	72.4/76.6
Q2201	1560000560	S.FET 2SK882-GR (TE85L)	T	109.3/85.5
Q2202	1560000560	S.FET 2SK882-GR (TE85L)	T	119.3/81.4
Q2203	1530002060	S.TR 2SC4081 T106 R	T	127.6/78.9
D101	1790000980	S.DIO MA742 (TX)	T	37.4/83.8
D103	1750000520	S.DIO DAN222TL	T	30.8/83.9
D104	1750000580	S.DIO 1SV307 (TPH3)	B	14.1/79.4
D151	1750000580	S.DIO 1SV307 (TPH3)	T	46/86
D152	1750000580	S.DIO 1SV307 (TPH3)	B	16.4/82.1
D201	1750000580	S.DIO 1SV307 (TPH3)	B	2.9/77.8
D301	1750000520	S.DIO DAN222TL	T	35.7/10
D302	1750000520	S.DIO DAN222TL	T	40.7/13.9
D303	1750000520	S.DIO DAN222TL	T	38.6/13.9
D351	1750000520	S.DIO DAN222TL	T	27.2/31.3
D352	1750000520	S.DIO DAN222TL	T	29.6/26.2
D353	1160000140	S.DIO DAP222 TL	T	33.5/16.5
D354	1160000140	S.DIO DAP222 TL	T	35.6/16.5
D501	1750000580	S.DIO 1SV307 (TPH3)	T	20.5/71.8
D502	1750000580	S.DIO 1SV307 (TPH3)	T	28.8/41.8
D551	1750000580	S.DIO 1SV307 (TPH3)	T	31/74.8
D552	1750000580	S.DIO 1SV307 (TPH3)	T	33/44.6
D601	1750000580	S.DIO 1SV307 (TPH3)	T	21.4/75.2
D602	1750000580	S.DIO 1SV307 (TPH3)	T	25.7/74.5
D603	1750000580	S.DIO 1SV307 (TPH3)	T	28.8/43.6
D604	1750000580	S.DIO 1SV307 (TPH3)	B	42/43.9
D651	1750000580	S.DIO 1SV307 (TPH3)	T	43.8/74.2
D652	1750000580	S.DIO 1SV307 (TPH3)	T	42.5/45.6
D701	1750000580	S.DIO 1SV307 (TPH3)	B	41.6/75.9
D702	1750000580	S.DIO 1SV307 (TPH3)	B	45.1/45.3
D751	1750000580	S.DIO 1SV307 (TPH3)	B	37.2/76
D752	1750000580	S.DIO 1SV307 (TPH3)	B	35.7/45.3
D801	1750000580	S.DIO 1SV307 (TPH3)	T	10.9/65.6
D802	1750000580	S.DIO 1SV307 (TPH3)	T	45.1/32.3
D851	1790000620	S.DIO MA77 (TX)	B	19.9/72.7
D852	1790000620	S.DIO MA77 (TX)	B	32/44.8
D951	1750000580	S.DIO 1SV307 (TPH3)	T	51.8/28.1
D1001	1750000970	S.DIO CPH5513-TL	T	103.5/27.5
D1002	1750000440	S.DIO 1SV263-TL	T	109.8/31.8
D1003	1750000970	S.DIO CPH5513-TL	T	107.1/27.5
D1004	1790001250	S.DIO MA2S111-(TX)	B	110.8/32.4
D1201	1750000970	S.DIO CPH5513-TL	T	103.5/46.2

S.=Surface mount

[RF-B UNIT]

REF NO.	ORDER NO.	DESCRIPTION	M.	H/V LOCATION
D1202	1790000620	S.DIO MA77 (TX)	T	100.7/59.4
D1203	1750000440	S.DIO 1SV263-TL	T	103.8/50.5
D1204	1750000970	S.DIO CPH5513-TL	T	107/46.2
D1205	1790001250	S.DIO MA2S111-(TX)	T	106/58.4
D1301	1750000580	S.DIO 1SV307 (TPH3)	T	93.4/64.1
D1302	1750000580	S.DIO 1SV307 (TPH3)	B	88.6/65.6
D1401	1750000580	S.DIO 1SV307 (TPH3)	B	43/35.7
D1451	1750000430	S.DIO HSB88WSTR	T	80.2/71
D1501	1790000620	S.DIO MA77 (TX)	T	104.2/73.8
D1551	1790000620	S.DIO MA77 (TX)	T	123.3/54.6
D1601	1790000620	S.DIO MA77 (TX)	T	119.3/51.7
D1751	1790000620	S.DIO MA77 (TX)	B	143/34.8
D1752	1750000430	S.DIO HSB88WSTR	T	140.4/71.2
D1753	1790000620	S.DIO MA77 (TX)	B	144.6/72.9
D1801	1750000580	S.DIO 1SV307 (TPH3)	T	154.7/86.5
D1851	1790000620	S.DIO MA77 (TX)	T	147.2/40.2
D1852	1750000430	S.DIO HSB88WSTR	T	153.4/61.7
D1853	1790000620	S.DIO MA77 (TX)	B	147.5/71.9
D1854	1750000580	S.DIO 1SV307 (TPH3)	T	155.7/77.2
D2001	1790001670	S.DIO RB706F-40T106	B	127/87.8
D2002	1790001250	S.DIO MA2S111-(TX)	B	135.8/94.1
D2101	1750000430	S.DIO HSB88WSTR	T	92.1/78.8
D2201	1750000440	S.DIO 1SV263-TL	T	119.2/77.5
F11701	2030000420	S.MLH FL-381	T	124.8/29.6
F12001	2020001320	CER CFJ455K8		
F12002	2020001800	S.CER SFECV13M3DA0001-B0	T	88/93.5
F12003	2020001800	S.CER SFECV13M3DA0001-B0	T	88/86.1
L101	6200007780	S.COL LQW2BHN12J01L	T	46.2/89.3
L102	6200007760	S.COL LQW2BHN82NJ01L	T	40.1/88.4
L103	6200010730	S.COL C2520C-68NG-A	T	10.7/80.3
L104	6200005490	S.COL NL 322522T-331J	B	9.3/67.5
L137	6190001650	COL ELC06D102E		
L151	6200005490	S.COL NL 322522T-331J	T	44.8/78.1
L201	6200009810	S.COL LQH31HNR61J01L	T	3.8/20
L202	6200001470	S.COL NL 322522T-R12J-3	T	3.3/23
L203	6200001710	S.COL NL 322522T-331J	T	3.9/27.6
L251	6200005490	S.COL NL 322522T-331J	B	12.2/76.1
L252	6200005490	S.COL NL 322522T-331J	B	10.4/72.5
L253	6180003560	COL SP0406-5FR6K-6		
L271	6180003550	COL SP0406-4R7K-6		
L401	6200003260	S.COL NL 322522T-101J	T	39.1/5.7
L456	6200003090	S.COL NL 322522T-2R7J-3	T	150.7/22.4
L501	6200010780	S.COL C2520C-1ROG-A	T	15.1/65.7
L502	6200010970	S.COL C2520C-1R8G-A (1.8U)	T	15.1/60.1
L503	6200010970	S.COL C2520C-1R8G-A (1.8U)	T	15.1/54.4
L504	6200010780	S.COL C2520C-1ROG-A	T	15.2/43.4
L505	6200010970	S.COL C2520C-1R8G-A (1.8U)	T	15.1/49.2
L551	6200010770	S.COL C2520C-R68G-A	T	34.8/70.4
L552	6200010950	S.COL C2520C-1R5G-A (1.5U)	T	34.8/64.7
L553	6200010950	S.COL C2520C-1R5G-A (1.5U)	T	34.8/59.1
L554	6200010770	S.COL C2520C-R68G-A	T	34.9/47.7
L555	6200010950	S.COL C2520C-1R5G-A (1.5U)	T	34.9/53.3
L601	6200010530	S.COL C2520C-R56G (0.56U)	T	25.1/70.3
L602	6200010450	S.COL C2520C-R82G (0.82U)	T	25.1/64.6
L603	6200010450	S.COL C2520C-R82G (0.82U)	T	25.1/59
L604	6200010530	S.COL C2520C-R56G (0.56U)	T	25.1/48
L605	6200010450	S.COL C2520C-R82G (0.82U)	T	25.1/53.3
L651	6200010870	S.COL C2520C-R33G (0.33U)	T	44.3/69.8
L652	6200010770	S.COL C2520C-R68G-A	T	44.3/64.1
L653	6200010770	S.COL C2520C-R68G-A	T	44.2/58.7
L654	6200010870	S.COL C2520C-R33G (0.33U)	T	44.4/47.5
L655	6200010770	S.COL C2520C-R68G-A	T	44.3/53.4
L701	6200010980	S.COL LQW2BHN27J03L	B	45.1/67.2
L702	6200008080	S.COL LQW2BHN22J01L	B	46.1/62.2
L703	6200010980	S.COL LQW2BHN27J03L	B	44.6/55.7
L751	6200008100	S.COL LQH31HNR14J01L	B	34.7/70.7
L753	6200007810	S.COL LQH31HN95NK01L	B	38.6/59.5
L754	6200008100	S.COL LQH31HNR14J01L	B	34.2/49.2
L801	6200010800	S.COL C2520C-4R7G-A	T	35.1/34
L802	6200010800	S.COL C2520C-4R7G-A	T	42.2/32.1
L851	6200007810	S.COL LQH31HN95NK01L	B	25/69.5
L852	6200009810	S.COL LQH31HNR61J01L	B	25/64.5
L853	6200009810	S.COL LQH31HNR61J01L	B	28.5/60
L854	6200009810	S.COL LQH31HNR61J01L	B	25/54.5
L855	6200007810	S.COL LQH31HN95NK01L	B	25/49.5
L901	6200005490	S.COL NL 322522T-331J	B	42.7/31.4
L902	6140003530	COL LR-395		
L903	6140003530	COL LR-395		
L971	6200005490	S.COL NL 322522T-331J	B	26.8/41.7
L972	6200005490	S.COL NL 322522T-331J	B	26.8/37.5
L1001	6200008280	S.COL 0.30-1.7-7TL 50N	T	61.6/20.2
L1002	6200008180	S.COL 0.25-1.9-10TL 107N	T	62.8/24.3
L1003	6200008360	S.COL 0.25-1.9-13TL	T	62.8/29.1
L1004	6200003400	S.COL LQH43MN331K01L	T	65.7/33.6
L1005	6200010870	S.COL C2520C-R33G (0.33U)	T	72.4/31.7
L1006	6200009690	S.COL LQH43CN101K01L	B	85.6/18.3
L1007	6140004420	COL LR-501		
L1008	6200008080	S.COL LQW2BHN22J01L	B	94.9/33.8
L1009	6200008080	S.COL LQW2BHN22J01L	B	95.4/19.6

M.=Mounted side (T: Mounted on the Top side, B: Mounted on the Bottom side)

[RF-B UNIT]

REF NO.	ORDER NO.	DESCRIPTION	M.	H/V LOCATION
L1010	6200009690	S.COL LQH43CN101K01L	T	99.9/21.2
L1011	6150005320	COL LS-546 7K7		
L1012	6200001830	S.COL NL 322522T-100J	B	105.3/24.5
L1013	6200001830	S.COL NL 322522T-100J	T	112.6/31.2
L1014	6200001830	S.COL NL 322522T-100J	B	111.5/28.3
L1015	6200001830	S.COL NL 322522T-100J	T	113.7/27.1
L1016	6200001830	S.COL NL 322522T-100J	T	112/12.5
L1017	6200010740	S.COL C2520C-R27G-A	T	108.9/15.7
L1018	6140003210	S.COL LR-358	T	122.5/46.1
L1019	6190001650	COL ELC06D102E		
L1020	6200003090	S.COL NL 322522T-2R7J-3	B	111.3/14.6
L1101	6130002960	S.COL 617DB-1327=P3	T	92.3/20.2
L1102	6200010730	S.COL C2520C-68NG-A	T	93/13.2
L1103	6200010730	S.COL C2520C-68NG-A	T	89.4/13.6
L1104	6200010720	S.COL C2520C-56NG-A	T	85.8/13.1
L1105	6200001830	S.COL NL 322522T-100J	T	81.3/13
L1106	6140003820	COL LR-441		
L1201	6200008280	S.COL 0.30-1.7-7TL 50N	T	61.8/37.8
L1202	6200008180	S.COL 0.25-1.9-10TL 107N	T	62.6/42.2
L1203	6200008360	S.COL 0.25-1.9-13TL	T	62/47
L1204	6200003400	S.COL LQH43MN331K01L	T	65.3/50.7
L1205	6200010870	S.COL C2520C-R33G (0.33U)	T	72.4/51.1
L1206	6200009690	S.COL LQH43CN101K01L	B	79.6/50.8
L1207	6140004420	COL LR-501		
L1208	6200008080	S.COL LQW2BHN22J01L	B	92.4/42.5
L1209	6200008080	S.COL LQW2BHN22J01L	B	91.6/54.5
L1210	6200009690	S.COL LQH43CN101K01L	T	97.9/56.1
L1211	6150005320	COL LS-546 7K7		
L1212	6200001830	S.COL NL 322522T-100J	B	105.3/45.1
L1213	6200001830	S.COL NL 322522T-100J	B	104.9/57.5
L1214	6200001830	S.COL NL 322522T-100J	B	107.6/51
L1215	6200001830	S.COL NL 322522T-100J	B	104.1/49
L1216	6200001830	S.COL NL 322522T-100J	B	110.8/46.4
L1217	6200001830	S.COL NL 322522T-100J	T	113.7/56.7
L1218	6200010740	S.COL C2520C-R27G-A	T	114.3/48.7
L1219	6200003090	S.COL NL 322522T-2R7J-3	B	111/64.4
L1220	6200003250	S.COL NL 322522T-R39J-3	B	98.9/57
L1301	6130002960	S.COL 617DB-1327=P3	T	91.8/54.9
L1302	6200001830	S.COL NL 322522T-100J	B	99/62.5
L1303	6200010730	S.COL C2520C-68NG-A	T	89.5/62.4
L1304	6200010730	S.COL C2520C-68NG-A	T	86.9/58.8
L1305	6200010720	S.COL C2520C-56NG-A	T	85.9/63.2
L1306	6200001830	S.COL NL 322522T-100J	T	73.7/55.9
L1307	6140003820	COL LR-441		
L1401	6200001710	S.COL NL 322522T-220J	T	50.2/40.2
L1402	6200000891	S.COL NL 322522T-R15M-3	T	52/46.4
L1403	6200003450	S.COL NL 322522T-082J	T	51.4/51.2
L1451	6130002960	S.COL 617DB-1327=P3	T	73.9/71
L1452	6130002960	S.COL 617DB-1327=P3	T	86.6/71
L1551	6200004600	S.COL MLF1608D R15K-T	T	97.3/70.3
L1552	6200004600	S.COL MLF1608D R15K-T	T	101.6/69.6
L1553	6150004280	COL LS-484B (C-14927)		
L1554	6200003030	S.COL NL 322522T-R47J-3	T	122.6/72.7
L1601	6200010760	S.COL C2520C-27NG-A	T	119.4/55.9
L1701	6150004280	COL LS-484B (C-14927)		
L1702	6150004280	COL LS-484B (C-14927)		
L1751	6150004280	COL LS-484B (C-14927)		
L1752	6150004280	COL LS-484B (C-14927)		
L1753	6140003530	COL LR-395		
L1754	6140003210	S.COL LR-358	T	139.8/76.9
L1755	6200010950	S.COL C2520C-1R5G-A (1.5U)	T	148.8/81.2
L1756	6200010950	S.COL C2520C-1R5G-A (1.5U)	T	150.4/84.8
L1801	6150004280	COL LS-484B (C-14927)		
L1802	6200005490	S.COL NL 322522T-331J	B	152.2/85
L1851	6140003210	S.COL LR-358	T	154.8/55.1
L1852	6140003530	COL LR-395		
L1853	6200005490	S.COL NL 322522T-331J	T	158.5/74.9
L2001	6200003260	S.COL NL 322522T-101J	B	123.3/88.6
L2002	6200003260	S.COL NL 322522T-101J	T	127.7/85.4
L2003	6200003260	S.COL NL 322522T-101J	T	133.4/81.5
L2004	6200001830	S.COL NL 322522T-100J	B	87.6/95
L2005	6200003080	S.COL NL 322522T-1R8J-3	T	91.8/84.4
L2101	6140003210	S.COL LR-358	T	85.5/78.7
L2102	6150004280	COL LS-484B (C-14927)		
L2103	6140003210	S.COL LR-358	T	98.7/78.8
L2201	6150004280	COL LS-484B (C-14927)		
L2202	6150004280	COL LS-484B (C-14927)		
L2203	6200003090	S.COL NL 322522T-2R7J-3	T	124.8/79.5
R101	7540000130	ASB 2P-50A-301		
R102	7030003560	S.RES ERJ3GEYJ 103 V (10 kΩ)	T	52.4/91.5
R103	7030003480	S.RES ERJ3GEYJ 222 V (2.2 kΩ)	T	33.1/82.5
R104	7030003680	S.RES ERJ3GEYJ 104 V (100 kΩ)	T	36/80
R105	7030003860	S.RES ERJ3GE JPW V	T	34.3/83.7
R106	7030003340	S.RES ERJ3GEYJ 151 V (150 Ω)	B	15.5/90.4
R107	7030008180	S.RES ERJ12YJ331U (330 Ω)	B	12.8/67.5
R108	7030003680	S.RES ERJ3GEYJ 104 V (100 kΩ)	T	6/70.2
R109	7030003560	S.RES ERJ3GEYJ 103 V (10 kΩ)	T	5.8/66.4
R110	7030003270	S.RES ERJ3GEYJ 390 V (39 Ω)	B	16.4/87.9
R111	7030003340	S.RES ERJ3GEYJ 151 V (150 Ω)	B	14.6/87.9
R112	7030003310	S.RES ERJ3GEYJ 820 V (82 Ω)	B	4/90.3
R113	7030003320	S.RES ERJ3GEYJ 101 V (100 Ω)	B	4/88.5

S.=Surface mount

[RF-B UNIT]

REF NO.	ORDER NO.	DESCRIPTION	M.	H/V LOCATION
R114	7030003310	S.RES ERJ3GEYJ 820 V (82 Ω)	B	6.6/89.3
R151	7030003560	S.RES ERJ3GEYJ 103 V (10 kΩ)	T	49.6/83.7
R152	7540000130	ASB 2P-50A-301		
R153	7030003560	S.RES ERJ3GEYJ 103 V (10 kΩ)	T	55.2/86.1
R154	7030003680	S.RES ERJ3GEYJ 104 V (100 kΩ)	T	46.4/81.3
R155	7030003480	S.RES ERJ3GEYJ 222 V (2.2 kΩ)	T	47.6/86.1
R156	7030008180	S.RES ERJ12YJ331U (330 Ω)	T	41/81.9
R157	7030003680	S.RES ERJ3GEYJ 104 V (100 kΩ)	T	47.4/79.4
R201	7030003400	S.RES ERJ3GEYJ 471 V (470 Ω)	T	5.8/17
R202	7030003200	S.RES ERJ3GEYJ 100 V (10 Ω)	T	3.9/17.5
R203	7030003400	S.RES ERJ3GEYJ 471 V (470 Ω)	T	5.8/18.2
R204	7030003640	S.RES ERJ3GEYJ 473 V (47 kΩ)	T	7.5/29.8
R205	7030003440	S.RES ERJ3GEYJ 102 V (1 kΩ)	T	9.4/29.2
R207	7030004040	S.RES ERJ3GEYJ 4R7 V (4.7 Ω)	T	7.4/25.8
R208	7030003560	S.RES ERJ3GEYJ 103 V (10 kΩ)	T	8.9/37.3
R209	7030000320	S.RES MCR10EZHU 330 Ω (331)	T	3.8/40.7
R210	7030003220	S.RES ERJ3GEYJ 150 V (15 Ω)	T	6/42.2
R211	7030000320	S.RES MCR10EZHU 330 Ω (331)	T	3.8/42.5
R212	7030007530	S.RES ERJ8ENF 1800V (180 Ω)	T	4.1/44.5
R213	7030003680	S.RES ERJ3GEYJ 104 V (100 kΩ)	T	7.6/37.6
R251	7030003680	S.RES ERJ3GEYJ 104 V (100 kΩ)	B	8/76.9
R301	7030005530	S.RES ERJ2GEJ 100 X (10 Ω)	T	27.9/13.4
R302	7030005530	S.RES ERJ2GEJ 100 X (10 Ω)	T	27.9/12.5
R303	7030005530	S.RES ERJ2GEJ 100 X (10 Ω)	T	27.9/11.6
R304	7030005530	S.RES ERJ2GEJ 100 X (10 Ω)	T	27.9/10.7
R305	7030005530	S.RES ERJ2GEJ 100 X (10 Ω)	T	27.9/9.8
R306	7030005530	S.RES ERJ2GEJ 100 X (10 Ω)	T	27.9/8.9
R307	7030005530	S.RES ERJ2GEJ 100 X (10 Ω)	T	27.9/8
R308	7030005050	S.RES ERJ2GEJ 103 X (10 kΩ)	T	30.7/13.4
R309	7030005050	S.RES ERJ2GEJ 103 X (10 kΩ)	T	30.7/12.5
R310	7030005050	S.RES ERJ2GEJ 103 X (10 kΩ)	T	30.7/11.6
R311	7030005050	S.RES ERJ2GEJ 103 X (10 kΩ)	T	30.7/10.7
R312	7030005050	S.RES ERJ2GEJ 103 X (10 kΩ)	T	30.7/9.8
R313	7030005050	S.RES ERJ2GEJ 103 X (10 kΩ)	T	30.7/8.9
R314	7030005050	S.RES ERJ2GEJ 103 X (10 kΩ)	T	30.7/8
R315	7030005530	S.RES ERJ2GEJ 100 X (10 Ω)	T	27.9/19.1
R316	7030005530	S.RES ERJ2GEJ 100 X (10 Ω)	T	27.9/18.2
R317	7030005530	S.RES ERJ2GEJ 100 X (10 Ω)	T	27.9/17.3
R318	7030005530	S.RES ERJ2GEJ 100 X (10 Ω)	T	27.9/16.4
R319	7030005530	S.RES ERJ2GEJ 100 X (10 Ω)	T	27.9/15.5
R320	7030005050	S.RES ERJ2GEJ 103 X (10 kΩ)	T	30.7/19.1
R321	7030005050	S.RES ERJ2GEJ 103 X (10 kΩ)	T	30.7/18.2
R322	7030005050	S.RES ERJ2GEJ 103 X (10 kΩ)	T	30.7/17.3
R323	7030005050	S.RES ERJ2GEJ 103 X (10 kΩ)	T	30.7/16.4
R324	7030005050	S.RES ERJ2GEJ 103 X (10 kΩ)	T	30.7/15.5
R325	7030005050	S.RES ERJ2GEJ 103 X (10 kΩ)	T	30.7/14.6
R326	7030005530	S.RES ERJ2GEJ 100 X (10 Ω)	T	27.9/14.6
R351	7030003520	S.RES ERJ3GEYJ 472 V (4.7 kΩ)	T	30.2/28.4
R352	7030003520	S.RES ERJ3GEYJ 472 V (4.7 kΩ)	T	29/28.4
R353	7030003860	S.RES ERJ3GE JPW V	T	35.4/25.6
R354	7030003560	S.RES ERJ3GEYJ 103 V (10 kΩ)	T	25.4/31.5
R357	7030003560	S.RES ERJ3GEYJ 103 V (10 kΩ)	T	21.6/29
R358	7030005050	S.RES ERJ2GEJ 103 X (10 kΩ)	T	30.4/22.8
R359	7030005050	S.RES ERJ2GEJ 103 X (10 kΩ)	T	30.4/23.7
R360	7030003860	S.RES ERJ3GE JPW V	B	24/6.9
R361	7030003860	S.RES ERJ3GE JPW V	B	19.3/27.8
R362	7030003860	S.RES ERJ3GE JPW V	B	46/11.8
R451	7030004050	S.RES ERJ3GEYJ 1R0 V (1 Ω)	T	149.3/10
R452	7030004050	S.RES ERJ3GEYJ 1R0 V (1 Ω)	T	149.3/8.8
R501	7030000260	S.RES MCR10EZHU 100 Ω (101)	T	17.7/41.5
R551	7030000260	S.RES MCR10EZHU 100 Ω (101)	T	37.7/46.2
R601	7030000260	S.RES MCR10EZHU 100 Ω (101)	T	28/46.4
R651	7030000260	S.RES MCR10EZHU 100 Ω (101)	T	46.9/45.7
R701	7030000260	S.RES MCR10EZHU 100 Ω (101)	B	41.4/50
R751	7030000260	S.RES MCR10EZHU 100 Ω (101)	B	38.8/49.1
R752	7030003860	S.RES ERJ3GE JPW V	B	35.6/67.7
R753	7030003860	S.RES ERJ3GE JPW V	B	32.9/56.7
R801	7030000260	S.RES MCR10EZHU 100 Ω (101)	T	32/37.1
R802	7030003300	S.RES ERJ3GEYJ 680 V (68 Ω)	T	31.5/34.1
R803	7030000260	S.RES MCR10EZHU 100 Ω (101)	T	34.4/38.7
R901	7030009220	S.RES ERJ12YJ561U	B	46.5/30.2
R902	7030003360	S.RES ERJ3GEYJ 221 V (220 Ω)	T	54.5/17.8
R951	7030003640	S.RES ERJ3GEYJ 473 V (47 kΩ)	T	50.8/30.3
R952	7030003650	S.RES ERJ3GEYJ 563 V (56 kΩ)	T	48.4/27.8
R953	7030003570	S.RES ERJ3GEYJ 123 V (12 kΩ)	T	48.4/30.4
R954	7030003480	S.RES ERJ3GEYJ 222 V (2.2 kΩ)	T	49.6/27.8
R971	7030008180	S.RES ERJ12YJ331U (330 Ω)	B	32/41.7
R972	7030009220	S.RES ERJ12YJ561U	B	32/37.5
R1001	7030000210	S.RES MCR10EZHU 39 Ω (390)	T	66.7/30.8
R1002	7030003400	S.RES ERJ3GEYJ 471 V (470 Ω)	T	85.9/29.6
R1003	7030003400	S.RES ERJ3GEYJ 471 V (470 Ω)	B	87.2/29.7
R1004	7030003400	S.RES ERJ3GEYJ 471 V (470 Ω)	T	87.2/24.5
R1005	7030003400	S.RES ERJ3GEYJ 471 V (470 Ω)	T	85.9/22.6
R1006	7310004650	S.TRI EVM-2WSX80 B53 (502)	T	87.2/27.7
R1007	7310004650	S.TRI EVM-2WSX80 B53 (502)	T	92.1/27.7
R1008	7030003320	S.RES ERJ3GEYJ 101 V (100 Ω)	B	94.4/36.4
R1009	7030003320	S.RES ERJ3GEYJ 101 V (100 Ω)	B	95.5/21.8
R1010	7030003360	S.RES ERJ3GEYJ 221 V (220 Ω)	B	98.5/27.7
R1011	7030003480	S.RES ERJ3GEYJ 222 V (2.2 kΩ)	T	105.8/31.1
R1012	7030003460	S.RES ERJ3GEYJ 152 V (1.5 kΩ)	T	103.2/31.2
R1013	7030003440	S.RES ERJ3GEYJ 102 V (1 kΩ)	T	102.1/33
R1014	7030003220	S.RES ERJ3GEYJ 150 V (15 Ω)	T	109.3/24.2
R1015	7030003560	S.RES ERJ3GEYJ 103 V (10 kΩ)	T	104.8/32.9

M.=Mounted side (T: Mounted on the Top side, B: Mounted on the Bottom side)

[RF-B UNIT]

REF NO.	ORDER NO.	DESCRIPTION	M.	H/V LOCATION
R1016	7030003280	S.RES ERJ3GEYJ 470 V (47 Ω)	T	111.5/24.9
R1017	7030003450	S.RES ERJ3GEYJ 122 V (1.2 kΩ)	T	112.6/18.3
R1018	7030003480	S.RES ERJ3GEYJ 221 V (2.2 kΩ)	T	112.6/17.1
R1019	7030003400	S.RES ERJ3GEYJ 472 V (470 Ω)	T	111.7/15.9
R1020	7030003360	S.RES ERJ3GEYJ 221 V (220 Ω)	T	118.2/46
R1101	7030007860	S.RES ERJ3GEYJ 8R2V (8.2 Ω)	T	94.1/16.6
R1102	7030003340	S.RES ERJ3GEYJ 151 V (150 Ω)	T	92.2/17
R1103	7030007860	S.RES ERJ3GEYJ 8R2V (8.2 Ω)	T	92.2/15.8
R1104	7030003280	S.RES ERJ3GEYJ 470 V (47 Ω)	T	81.5/15.9
R1105	7030005280	S.RES ERJ3GEYJ 6R8V (6.8 Ω)	T	79.1/15.9
R1106	7030003420	S.RES ERJ3GEYJ 681 V (680 Ω)	B	74.5/16.2
R1107	7030003420	S.RES ERJ3GEYJ 681 V (680 Ω)	T	76.2/20.9
R1108	7030003390	S.RES ERJ3GEYJ 391 V (390 Ω)	T	83.9/21.6
R1201	7030000210	S.RES MCR10EZHU 39 Ω (390)	T	66.6/46.7
R1202	7030003400	S.RES ERJ3GEYJ 471 V (470 Ω)	B	85.8/52.6
R1203	7030003400	S.RES ERJ3GEYJ 471 V (470 Ω)	T	86.3/50.5
R1204	7030003400	S.RES ERJ3GEYJ 471 V (470 Ω)	T	86.3/44.5
R1205	7030003400	S.RES ERJ3GEYJ 471 V (470 Ω)	B	86.2/43.8
R1206	7310004650	S.TRI EVM-2WSX80 B53 (502)	T	87/48.2
R1207	7310004650	S.TRI EVM-2WSX80 B53 (502)	T	92/48.2
R1208	7030003320	S.RES ERJ3GEYJ 101 V (100 Ω)	B	92.4/40.2
R1209	7030003320	S.RES ERJ3GEYJ 101 V (100 Ω)	B	91.4/56.6
R1210	7030003360	S.RES ERJ3GEYJ 221 V (220 Ω)	B	101.3/47.8
R1211	7030003200	S.RES ERJ3GEYJ 100 V (10 Ω)	B	100.5/54.1
R1212	7030003480	S.RES ERJ3GEYJ 222 V (2.2 kΩ)	B	103/54.8
R1213	7030003480	S.RES ERJ3GEYJ 222 V (2.2 kΩ)	T	103.3/52.8
R1214	7030003460	S.RES ERJ3GEYJ 152 V (1.5 kΩ)	T	105.2/53.4
R1215	7030003440	S.RES ERJ3GEYJ 102 V (1 kΩ)	T	103.3/54
R1216	7030003220	S.RES ERJ3GEYJ 150 V (15 Ω)	T	110.1/47.4
R1217	7030003560	S.RES ERJ3GEYJ 103 V (10 kΩ)	T	103.6/56.7
R1218	7030003280	S.RES ERJ3GEYJ 470 V (47 Ω)	T	110.8/45.5
R1219	7030003450	S.RES ERJ3GEYJ 122 V (1.2 kΩ)	T	107.8/56.3
R1220	7030003480	S.RES ERJ3GEYJ 221 V (2.2 kΩ)	T	105.9/55.2
R1221	7030003400	S.RES ERJ3GEYJ 472 V (470 Ω)	T	112.1/49.6
R1222	7030003600	S.RES ERJ3GEYJ 223 V (22 kΩ)	B	98.7/54.1
R1223	7030003280	S.RES ERJ3GEYJ 470 V (47 Ω)	B	95.8/59.7
R1224	7030003340	S.RES ERJ3GEYJ 151 V (150 Ω)	B	96.9/54.1
R1301	7030007860	S.RES ERJ3GEYJ 8R2V (8.2 Ω)	T	96.6/60.4
R1302	7030003340	S.RES ERJ3GEYJ 151 V (150 Ω)	T	95.4/61
R1303	7030007860	S.RES ERJ3GEYJ 8R2V (8.2 Ω)	T	94.1/62
R1304	7030003440	S.RES ERJ3GEYJ 102 V (1 kΩ)	T	94/58.8
R1305	7030003280	S.RES ERJ3GEYJ 470 V (47 Ω)	T	72.3/58.6
R1306	7030005280	S.RES ERJ3GEYJ 6R8V (6.8 Ω)	T	74.7/58.6
R1307	7030003420	S.RES ERJ3GEYJ 681 V (680 Ω)	T	82.5/62.1
R1308	7030003420	S.RES ERJ3GEYJ 681 V (680 Ω)	T	79.9/63.1
R1309	7030003390	S.RES ERJ3GEYJ 391 V (390 Ω)	T	72.3/63.1
R1401	7030003340	S.RES ERJ3GEYJ 151 V (150 Ω)	T	50.7/35.2
R1402	7030003270	S.RES ERJ3GEYJ 390 V (39 Ω)	T	50.7/36.4
R1403	7030003340	S.RES ERJ3GEYJ 151 V (150 Ω)	T	52.6/36.3
R1404	7030003320	S.RES ERJ3GEYJ 101 V (100 Ω)	T	54.5/36.9
R1405	7030003320	S.RES ERJ3GEYJ 101 V (100 Ω)	T	54.8/50.5
R1406	7030003200	S.RES ERJ3GEYJ 100 V (10 Ω)	T	51.4/43.1
R1451	7030003430	S.RES ERJ3GEYJ 821 V (820 Ω)	B	91.1/73.8
R1452	7030003350	S.RES ERJ3GEYJ 181 V (180 Ω)	B	88.6/72.7
R1453	7030003260	S.RES ERJ3GEYJ 300 V (33 Ω)	B	86.8/69.4
R1454	7030003350	S.RES ERJ3GEYJ 181 V (180 Ω)	B	88.6/69.4
R1502	7030003480	S.RES ERJ3GEYJ 222 V (2.2 kΩ)	T	102/73
R1503	7030003290	S.RES ERJ3GEYJ 560 V (56 Ω)	T	98.1/73
R1504	7030003480	S.RES ERJ3GEYJ 221 V (2.2 kΩ)	T	96.2/73.8
R1552	7030003320	S.RES ERJ3GEYJ 101 V (100 Ω)	T	117.9/70.6
R1553	7510001490	S.TMR NTCG16 3NH 681KT	T	123.9/67.9
R1554	7030003480	S.RES ERJ3GEYJ 222 V (2.2 kΩ)	T	122.7/67.9
R1555	7030003440	S.RES ERJ3GEYJ 102 V (1 kΩ)	T	119.1/67.9
R1556	7030003440	S.RES ERJ3GEYJ 151 V (150 Ω)	T	117.9/67.9
R1557	7030000400	S.RES ERJ3GEYJ 4R7 V (4.7 Ω)	T	125.2/73.2
R1558	7030003440	S.RES ERJ3GEYJ 102 V (1 kΩ)	T	126.4/70.6
R1601	7030003440	S.RES ERJ3GEYJ 102 V (1 kΩ)	T	121.5/52.5
R1602	7030003280	S.RES ERJ3GEYJ 470 V (47 Ω)	T	119.5/53.2
R1603	7030003280	S.RES ERJ3GEYJ 470 V (47 Ω)	T	119.6/58.5
R1701	7030003440	S.RES ERJ3GEYJ 102 V (1 kΩ)	B	144.5/37.4
R1751	7030003440	S.RES ERJ3GEYJ 102 V (1 kΩ)	B	138.4/35.3
R1752	7030003200	S.RES ERJ3GEYJ 100 V (10 Ω)	T	139.7/45
R1753	7030003560	S.RES ERJ3GEYJ 103 V (10 kΩ)	T	144.3/45.4
R1754	7030003280	S.RES ERJ3GEYJ 470 V (47 Ω)	T	143.1/45.4
R1755	7030003470	S.RES ERJ3GEYJ 182 V (1.8 kΩ)	T	139.7/46.2
R1756	7030003470	S.RES ERJ3GEYJ 182 V (1.8 kΩ)	T	139.7/47.4
R1757	7030003600	S.RES ERJ3GEYJ 223 V (22 kΩ)	T	136.9/47.4
R1758	7030003300	S.RES ERJ3GEYJ 680 V (68 Ω)	T	139.7/49.8
R1759	7030003480	S.RES ERJ3GEYJ 222 V (2.2 kΩ)	B	140.2/50.3
R1760	7030003280	S.RES ERJ3GEYJ 470 V (47 Ω)	T	136.9/46.2
R1761	7030003430	S.RES ERJ3GEYJ 821 V (820 Ω)	T	144.3/82
R1762	7030003370	S.RES ERJ3GEYJ 271 V (270 Ω)	T	143.5/80.8
R1763	7030003370	S.RES ERJ3GEYJ 271 V (270 Ω)	T	144.1/77.8
R1764				

[RF-B UNIT]

REF NO.	ORDER NO.	DESCRIPTION	M.	H/V LOCATION
R1853	7030003420	S.RES ERJ3GEYJ 681 V (680 Ω)	T	150.1/53.5
R1854	7030003420	S.RES ERJ3GEYJ 681 V (680 Ω)	T	151.1/52.1
R1855	7030003420	S.RES ERJ3GEYJ 681 V (680 Ω)	B	148.5/70.1
R1856	7030003430	S.RES ERJ3GEYJ 821 V (820 Ω)	T	150.1/74.2
R1857	7030003380	S.RES ERJ3GEYJ 331 V (330 Ω)	T	150.8/75.4
R1858	7030003220	S.RES ERJ3GEYJ 150 V (15 Ω)	T	153.4/75.4
R1859	7030003380	S.RES ERJ3GEYJ 331 V (330 Ω)	T	153.4/76.6
R1860	7030000340	S.RES MCR10EZHZ 470 Ω (471)	T	158.6/77.3
R1861	7030003370	S.RES ERJ3GEYJ 271 V (270 Ω)	B	153.8/72.4
R1862	7030003370	S.RES ERJ3GEYJ 271 V (270 Ω)	B	151.1/74.7
R1863	7030003230	S.RES ERJ3GEYJ 180 V (18 Ω)	B	151.1/72.9
R2001	7030003360	S.RES ERJ3GEYJ 221 V (220 Ω)	B	93.8/93.4
R2002	7030003360	S.RES ERJ3GEYJ 221 V (220 Ω)	T	96.1/95.8
R2003	7030003280	S.RES ERJ3GEYJ 470 V (47 Ω)	B	95.4/87
R2004	7030003440	S.RES ERJ3GEYJ 102 V (1 kΩ)	T	125.2/90.6
R2005	7030003440	S.RES ERJ3GEYJ 102 V (1 kΩ)	B	92.3/91.6
R2006	7030003800	S.RES ERJ3GEYJ 105 V (1 MΩ)	B	135.7/88.7
R2007	7030003480	S.RES ERJ3GEYJ 222 V (2.2 kΩ)	B	135.7/92.3
R2008	7030003750	S.RES ERJ3GEYJ 394 V (390 kΩ)	T	125.2/93.2
R2009	7030003670	S.RES ERJ3GEYJ 823 V (82 kΩ)	B	127.4/95.8
R2010	7030003680	S.RES ERJ3GEYJ 104 V (100 kΩ)	T	125.2/95.8
R2011	7030003840	S.RES ERJ3GEYJ 225 V (2.2 MΩ)	B	134.6/95.8
R2012	7310002590	S.TRI RV-109 (RH03A3AJ3X0BA) 222	T	127.6/94.4
R2013	7030003760	S.RES ERJ3GEYJ 474 V (470 kΩ)	B	131.2/95.8
R2014	7030003580	S.RES ERJ3GEYJ 153 V (15 kΩ)	T	126.4/90.6
R2015	7030003680	S.RES ERJ3GEYJ 104 V (100 kΩ)	T	94.3/95.8
R2016	7310002580	S.TRI RV-108 (RH03A3AJ15X05A) 104	T	131.1/94.4
R2017	7030003700	S.RES ERJ3GEYJ 154 V (150 kΩ)	T	127.6/90.6
R2101	7030003380	S.RES ERJ3GEYJ 331 V (330 Ω)	B	81.8/83.8
R2102	7030003220	S.RES ERJ3GEYJ 150 V (15 Ω)	B	83.6/81.2
R2103	7030003380	S.RES ERJ3GEYJ 331 V (330 Ω)	B	84.4/83.8
R2104	7030003320	S.RES ERJ3GEYJ 101 V (100 Ω)	B	80.2/76.8
R2106	7030003280	S.RES ERJ3GEYJ 470 V (47 Ω)	B	71/82.4
R2201	7030003380	S.RES ERJ3GEYJ 331 V (330 Ω)	B	98.4/80
R2202	7030003220	S.RES ERJ3GEYJ 150 V (15 Ω)	B	101.2/81.2
R2203	7030003380	S.RES ERJ3GEYJ 331 V (330 Ω)	B	98.4/81.8
R2204	7030003280	S.RES ERJ3GEYJ 470 V (47 Ω)	B	101.5/78.7
R2205	7030003420	S.RES ERJ3GEYJ 681 V (680 Ω)	T	111.3/85.2
R2206	7030003340	S.RES ERJ3GEYJ 151 V (150 Ω)	T	116.2/85.8
R2207	7030003280	S.RES ERJ3GEYJ 470 V (47 Ω)	B	120.1/80.1
R2208	7030003520	S.RES ERJ3GEYJ 472 V (4.7 kΩ)	T	121/83.7
R2209	7030003340	S.RES ERJ3GEYJ 151 V (150 Ω)	T	119.2/84.6
R2210	7030003440	S.RES ERJ3GEYJ 102 V (1 kΩ)	T	119.3/79.4
R2211	7030003440	S.RES ERJ3GEYJ 102 V (1 kΩ)	T	124.8/76.9
R2212	7030003560	S.RES ERJ3GEYJ 103 V (10 kΩ)	T	127/81.6
R2213	7030003560	S.RES ERJ3GEYJ 103 V (10 kΩ)	T	129.5/79
R2214	7030003440	S.RES ERJ3GEYJ 102 V (1 kΩ)	T	130.1/80.9
R2301	7030000260	S.RES MCR10EZHZ 100 Ω (101)	B	28.7/52.2
C101	4030007090	S.CER C1608 CH 1H 470J-T	T	41/91.7
C102	4030007030	S.CER C1608 CH 1H 150J-T	T	43.6/90.2
C103	4030007120	S.CER C1608 CH 1H 820J-T	T	39.8/91.7
C104	4030011540	S.CER C1608 CH 1H 750J-T	T	42.3/89.1
C105	4030007070	S.CER C1608 CH 1H 330J-T	T	38.6/91.7
C106	4030011600	S.CER C1608 JB 1E 104K-T	T	37.9/88.7
C107	4030006880	S.CER C1608 JB 1H 472K-T	B	29.8/86.2
C108	4030009520	S.CER C1608 CH 1H 020B-T	T	36.6/86.7
C109	4030007050	S.CER C1608 CH 1H 220J-T	T	35.5/83.7
C110	4030011600	S.CER C1608 JB 1E 104K-T	T	14.1/80.3
C111	4030011600	S.CER C1608 JB 1E 104K-T	T	8.5/68.9
C112	4030011600	S.CER C1608 JB 1E 104K-T	T	8.4/65.9
C113	4030010760	S.CER C1608 CH 1H 331J-T	T	37.3/81.8
C114	4030006880	S.CER C1608 JB 1H 472K-T	B	15.5/85.4
C115	4030006880	S.CER C1608 JB 1H 472K-T	T	2.2/88.8
C117	4030006880	S.CER C1608 JB 1H 472K-T	T	32.7/85.5
C151	4030011600	S.CER C1608 JB 1E 104K-T	T	49.5/86.8
C152	4030011600	S.CER C1608 JB 1E 104K-T	T	43.5/83.7
C153	4030011600	S.CER C1608 JB 1E 104K-T	T	49.6/82.5
C154	4030011600	S.CER C1608 JB 1E 104K-T	T	44/85.8
C155	4030011600	S.CER C1608 JB 1E 104K-T	T	48.6/79.4
C201	4030007010	S.CER C1608 CH 1H 100D-T	T	7.3/20.3
C202	4030007120	S.CER C1608 CH 1H 820J-T	T	7.3/21.5
C203	4030007020	S.CER C1608 CH 1H 120J-T	T	5.5/22.2
C204	4030007120	S.CER C1608 CH 1H 820J-T	T	7.3/23
C205	4030011600	S.CER C1608 JB 1E 104K-T	T	5.5/24.8
C206	4030011600	S.CER C1608 JB 1E 104K-T	T	4.6/29.8
C207	4030011600	S.CER C1608 JB 1E 104K-T	T	8.9/39.9
C208	4030011600	S.CER C1608 JB 1E 104K-T	T	6/39.6
C209	4030011600	S.CER C1608 JB 1E 104K-T	T	2.9/39
C251	4030011600	S.CER C1608 JB 1E 104K-T	B	13.6/72.5
C252	4030011600	S.CER C1608 JB 1E 104K-T	B	9.8/76.1
C271	4030017850	S.CER C2012 CH 1H 272J-T	T	9.3/77.8
C272	4030017860	S.CER C2012 CH 1H 332J-T	T	13.5/77.2
C273	4030017860	S.CER C2012 CH 1H 332J-T	T	11.7/77.2
C274	4030017830	S.CER C2012 CH 1H 152J-T	T	16/77.4
C301	4030011600	S.CER C1608 JB 1E 104K-T	B	38.6/6.1
C302	4030011600	S.CER C1608 JB 1E 104K-T	B	36.8/16.7
C330	4030011600	S.CER C1608 JB 1E 104K-T	B	112.5/58.9
C332	4510004630	S.ELE ECEV1CA100SR	T	106.8/61.9
C334	4030011600	S.CER C1608 JB 1E 104K-T	B	114.3/58.9
C401	4030011600	S.CER C1608 JB 1E 104K-T	T	43.5/13.4
C402	4030011600	S.CER C1608 JB 1E 104K-T	T	43.2/21.2

M.=Mounted side (T: Mounted on the Top side, B: Mounted on the Bottom side)

[RF-B UNIT]

REF NO.	ORDER NO.	DESCRIPTION	M.	H/V LOCATION
C403	4030011600	S.CER C1608 JB 1E 104K-T	T	40.4/28.1
C451	4030006880	S.CER C1608 JB 1H 472K-T	B	136.4/14.5
C452	4030011600	S.CER C1608 JB 1E 104K-T	T	149.3/7.6
C453	4510004630	S.ELE ECEV1CA100SR	T	146.5/3.3
C454	4030011600	S.CER C1608 JB 1E 104K-T	T	138.5/2.5
C455	4510004630	S.ELE ECEV1CA100SR	T	141.7/3.3
C456	4030011600	S.CER C1608 JB 1E 104K-T	T	137.3/2.5
C457	4510004630	S.ELE ECEV1CA100SR	T	134.1/4.8
C458	4510004590	ELE 16 MV 470 HC		
C460	4030007130	S.CER C1608 CH 1H 101J-T	B	146.4/14.5
C461	4030007130	S.CER C1608 CH 1H 101J-T	B	144.4/14.5
C462	4030017810	S.CER C1608 CH 1H 102J-T	B	143.4/11.4
C463	4030011600	S.CER C1608 JB 1E 104K-T	B	140.4/14.5
C464	4030011600	S.CER C1608 JB 1E 104K-T	B	139.4/11.4
C465	4030017810	S.CER C1608 CH 1H 102J-T	B	134.4/14.5
C466	4030017810	S.CER C1608 CH 1H 102J-T	B	133.4/11.4
C467	4030017810	S.CER C1608 CH 1H 102J-T	B	132.4/14.5
C468	4030017810	S.CER C1608 CH 1H 102J-T	B	131.4/11.4
C469	4030007130	S.CER C1608 CH 1H 101J-T	B	129.4/11.4
C470	4030007130	S.CER C1608 CH 1H 101J-T	B	128.4/14.5
C471	4030007130	S.CER C1608 CH 1H 101J-T	B	127.4/11.4
C473	4030006880	S.CER C1608 JB 1H 472K-T	B	134.6/5.3
C474	4030007130	S.CER C1608 CH 1H 101J-T	B	145.5/19.5
C475	4030011600	S.CER C1608 JB 1E 104K-T	B	140.6/5.3
C476	4030007130	S.CER C1608 CH 1H 101J-T	B	143.7/19.5
C477	4030017810	S.CER C1608 CH 1H 102J-T	B	144.1/5.1
C478	4030011600	S.CER C1608 JB 1E 104K-T	T	141.6/22.2
C479	4030011600	S.CER C1608 JB 1E 104K-T	B	140.4/21.9
C480	4030011600	S.CER C1608 JB 1E 104K-T	T	130.2/7.1
C481	4030017810	S.CER C1608 CH 1H 102J-T	T	136.6/20.5
C482	4030017810	S.CER C1608 CH 1H 102J-T	B	133.5/19.5
C483	4030017810	S.CER C1608 CH 1H 102J-T	T	131.5/21.3
C484	4030007130	S.CER C1608 CH 1H 101J-T	T	129.9/19.4
C485	4030011600	S.CER C1608 JB 1E 104K-T	T	115.6/7.6
C486	4030011600	S.CER C1608 JB 1E 104K-T	T	115.6/8.8
C501	4030007170	S.CER C1608 CH 1H 221J-T	T	17.4/68.6
C502	4030011600	S.CER C1608 JB 1E 104K-T	T	18.2/66.6
C503	4030007110	S.CER C1608 CH 1H 680J-T	T	18.6/68.6
C504	4030007090	S.CER C1608 CH 1H 470J-T	T	19.3/59.3
C505	4030007090	S.CER C1608 CH 1H 470J-T	T	19.3/57.9
C506	4030007070	S.CER C1608 CH 1H 330J-T	T	16.1/57.2
C507	4030007070	S.CER C1608 CH 1H 330J-T	T	17.3/57.2
C508	4030007090	S.CER C1608 CH 1H 470J-T	T	19.3/56.4
C509	4030007090	S.CER C1608 CH 1H 470J-T	T	19.3/55.2
C510	4030007070	S.CER C1608 CH 1H 330J-T	T	12.4/51.8
C511	4030007070	S.CER C1608 CH 1H 330J-T	T	13.6/51.8
C512	4030007090	S.CER C1608 CH 1H 470J-T	T	18.2/52.6
C513	4030007090	S.CER C1608 CH 1H 470J-T	T	18.2/51.4
C514	4030007170	S.CER C1608 CH 1H 221J-T	T	18.2/47.7
C515	4030011600	S.CER C1608 JB 1E 104K-T	T	19.7/45
C516	4030007110	S.CER C1608 CH 1H 680J-T	T	18.2/46.4
C551	4030007160	S.CER C1608 CH 1H 181J-T	T	38.1/73.6
C552	4030011600	S.CER C1608 JB 1E 104K-T	T	37.6/71.6
C553	4030007090	S.CER C1608 CH 1H 470J-T	T	36.8/73.6
C554	4030007040	S.CER C1608 CH 1H 180J-T	T	39/63.9
C555	4030007090	S.CER C1608 CH 1H 470J-T	T	39/62.6
C556	4030007050	S.CER C1608 CH 1H 220J-T	T	37.1/61.9
C557	4030007030	S.CER C1608 CH 1H 150J-T	T	35.9/61.9
C558	4030006990	S.CER C1608 CH 1H 080D-T	T	39/61.1
C559	4030007090	S.CER C1608 CH 1H 470J-T	T	39/59.9
C560	4030007050	S.CER C1608 CH 1H 220J-T	T	31.5/56.1
C561	4030007030	S.CER C1608 CH 1H 150J-T	T	32.8/56.1
C562	4030007040	S.CER C1608 CH 1H 180J-T	T	38.1/56.6
C563	4030007090	S.CER C1608 CH 1H 470J-T	T	38.1/55.3
C564	4030007160	S.CER C1608 CH 1H 181J-T	T	38/50.7
C565	4030011600	S.CER C1608 JB 1E 104K-T	T	39.5/49.4
C566	4030007090	S.CER C1608 CH 1H 470J-T	T	38/52
C601	4030007040	S.CER C1608 CH 1H 180J-T	T	27.2/73.3
C602	4030011600	S.CER C1608 JB 1E 104K-T	T	27.9/71.4
C603	4030007140	S.CER C1608 CH 1H 121J-T	T	28.5/73.3
C604	4030007040	S.CER C1608 CH 1H 180J-T	T	29.4/63.9
C605	4030007070	S.CER C1608 CH 1H 330J-T	T	29.4/62.7
C606	4030007070	S.CER C1608 CH 1H 330J-T	T	26.2/61.9
C607	4030007010	S.CER C1608 CH 1H 100D-T	T	27.5/61.9
C609	4030007090	S.CER C1608 CH 1H 470J-T	T	29.4/59.9
C610	4030007070	S.CER C1608 CH 1H 330J-T	T	21.7/56.2
C611	4030007010	S.CER C1608 CH 1H 100D-T	T	23/56
C612	4030007040	S.CER C1608 CH 1H 180J-T	T	28.4/56.5
C613	4030007070	S.CER C1608 CH 1H 330J-T	T	28.4/55.2
C614	4030007040	S.CER C1608 CH 1H 180J-T	T	28.4/52.1
C615	4030011600	S.CER C1608 JB 1E 104K-T	T	29.8/49.6
C616	4030007140	S.CER C1608 CH 1H 121J-T	T	28.4/50.8
C651	4030007130	S.CER C1608 CH 1H 101J-T	T	46/73.3
C652	4030011600	S.CER C1608 JB 1E 104K-T		

[RF-B UNIT]

REF NO.	ORDER NO.	DESCRIPTION	M.	H/V LOCATION
C664	4030007130	S.CER C1608 CH 1H 101J-T	T	46.1/49.9
C665	4030011600	S.CER C1608 JB 1E 104K-T	T	47.6/52.3
C666	4030007030	S.CER C1608 CH 1H 150J-T	T	46.1/51.1
C701	4030007100	S.CER C1608 CH 1H 560J-T	B	45.1/69.2
C702	4030011600	S.CER C1608 JB 1E 104K-T	B	44/62.7
C704	4030007110	S.CER C1608 CH 1H 680J-T	B	44.3/58.7
C706	4030007100	S.CER C1608 CH 1H 560J-T	B	44.6/51.7
C707	4030011600	S.CER C1608 JB 1E 104K-T	B	42.5/58.7
C752	4030011600	S.CER C1608 JB 1E 104K-T	B	32.1/73.9
C756	4030007090	S.CER C1608 CH 1H 470J-T	B	35.6/64.4
C757	4030006990	S.CER C1608 CH 1H 080D-T	B	33.8/64.4
C760	4030007090	S.CER C1608 CH 1H 470J-T	B	35.6/61.1
C765	4030011600	S.CER C1608 JB 1E 104K-T	B	39/52.3
C801	4030011600	S.CER C1608 JB 1E 104K-T	T	32.8/34.1
C802	4030011600	S.CER C1608 JB 1E 104K-T	T	31.9/40
C805	4030017850	S.CER C2012 CH 1H 272J-T	T	39.3/33.6
C806	4030017820	S.CER C2012 CH 1H 122J-T	T	42/34.5
C807	4030017800	S.CER C1608 CH 1H 561J-T	T	42.7/29.8
C851	4030007140	S.CER C1608 CH 1H 121J-T	B	25/67
C852	4030011600	S.CER C1608 JB 1E 104K-T	B	29.4/65.8
C853	4030011770	S.CER C1608 CH 1H 060B-T	B	29.4/64
C854	4030011770	S.CER C1608 CH 1H 060B-T	B	29.4/62.2
C855	4030009550	S.CER C1608 CH 1H 2R5B-T	B	23.2/61.1
C856	4030009920	S.CER C1608 CH 1H 050B-T	B	25/61.1
C857	4030007010	S.CER C1608 CH 1H 100D-T	B	29.4/57.8
C858	4030009920	S.CER C1608 CH 1H 050B-T	B	23.2/57.8
C859	4030009550	S.CER C1608 CH 1H 2R5B-T	B	25/57.8
C860	4030011770	S.CER C1608 CH 1H 060B-T	B	29.4/54.2
C861	4030011770	S.CER C1608 CH 1H 060B-T	B	29.4/56
C862	4030007030	S.CER C1608 CH 1H 150J-T	B	25/52
C863	4030007140	S.CER C1608 CH 1H 121J-T	B	25/47.3
C864	4030011600	S.CER C1608 JB 1E 104K-T	B	29.3/50.1
C901	4030011600	S.CER C1608 JB 1E 104K-T	T	50.1/13.8
C951	4030011600	S.CER C1608 JB 1E 104K-T	T	49.6/30.4
C952	4030007170	S.CER C1608 CH 1H 221J-T	T	48.4/25.2
C971	4030011600	S.CER C1608 JB 1E 104K-T	B	35.7/39.7
C1001	4030007050	S.CER C1608 CH 1H 220J-T	T	66.4/20.6
C1002	4030007140	S.CER C1608 CH 1H 121J-T	T	59.2/22.6
C1004	4030007070	S.CER C1608 CH 1H 330J-T	T	66.4/23
C1005	4030007080	S.CER C1608 CH 1H 390J-T	T	66.4/21.8
C1006	4030007090	S.CER C1608 CH 1H 470J-T	T	59.9/25.3
C1007	4030007080	S.CER C1608 CH 1H 390J-T	T	66.4/24.2
C1008	4030007100	S.CER C1608 CH 1H 560J-T	T	66.4/25.4
C1009	4030007030	S.CER C1608 CH 1H 150J-T	T	64.4/26.6
C1010	4030007100	S.CER C1608 CH 1H 560J-T	T	66.4/26.6
C1011	4030011600	S.CER C1608 JB 1E 104K-T	T	66.4/27.8
C1012	4030007030	S.CER C1608 CH 1H 150J-T	T	73.2/29
C1013	4030011600	S.CER C1608 JB 1E 104K-T	T	73/21.4
C1014	4030007020	S.CER C1608 CH 1H 120J-T	B	85.2/27
C1015	4030011600	S.CER C1608 JB 1E 104K-T	B	85.9/31.4
C1016	4030011600	S.CER C1608 JB 1E 104K-T	T	87.2/30.9
C1017	4030011600	S.CER C1608 JB 1E 104K-T	T	87.2/25.7
C1018	4030011600	S.CER C1608 JB 1E 104K-T	B	85.9/24.4
C1019	4030007030	S.CER C1608 CH 1H 150J-T	T	93.2/30.3
C1020	4030007030	S.CER C1608 CH 1H 150J-T	T	93.1/25.1
C1021	4030011600	S.CER C1608 JB 1E 104K-T	B	101.6/27.7
C1022	4030011340	S.CER C1608 CH 1H 471J-T	T	103.8/24.9
C1023	4030006880	S.CER C1608 JB 1H 472K-T	T	106.4/24.9
C1024	4030011340	S.CER C1608 CH 1H 471J-T	T	105.8/29.9
C1025	4030011600	S.CER C1608 JB 1E 104K-T	T	100.9/33
C1026	4030006880	S.CER C1608 JB 1H 472K-T	T	108.4/29.9
C1027	4030006880	S.CER C1608 JB 1H 472K-T	T	110.1/28.5
C1028	4030006880	S.CER C1608 JB 1H 472K-T	T	110.1/26.5
C1029	4030011600	S.CER C1608 JB 1E 104K-T	T	109.6/33.8
C1030	4550006080	S.TAN TEESVB2 1C 106M8L	B	105.9/31.4
C1031	4030006900	S.CER C1608 JB 1H 103K-T	T	112.6/19.5
C1032	4030006900	S.CER C1608 JB 1H 103K-T	T	112.5/14.7
C1033	4030011600	S.CER C1608 JB 1E 104K-T	T	108.6/12
C1034	4030009530	S.CER C1608 CH 1H 030B-T	T	112.6/20.7
C1035	4030007030	S.CER C1608 CH 1H 150J-T	B	112.6/19.6
C1036	4540000020	S.TRI TZY2Z060A001R00	T	113.5/22.7
C1037	4030011600	S.CER C1608 JB 1E 104K-T	B	96.2/12.5
C1038	4510004630	S.ELE ECEV1CA100SR	T	104.9/14
C1039	4030011600	S.CER C1608 JB 1E 104K-T	B	99.5/12.5
C1040	4030011600	S.CER C1608 JB 1E 104K-T	B	113.7/13.9
C1101	4030007040	S.CER C1608 CH 1H 180J-T	T	89.6/17
C1102	4030006980	S.CER C1608 CH 1H 070D-T	T	89.6/15.8
C1103	4030008560	S.CER C1608 CH 1H 300J-T	T	87/17
C1104	4030007020	S.CER C1608 CH 1H 120J-T	T	87/15.8
C1105	4030007060	S.CER C1608 CH 1H 270J-T	T	85.2/16.5
C1106	4030017810	S.CER C1608 CH 1H 102J-T	B	86.8/12.7
C1107	4030011600	S.CER C1608 JB 1E 104K-T	T	83.9/16.5
C1108	4030006900	S.CER C1608 JB 1H 103K-T	T	82.7/15.9
C1109	4030006900	S.CER C1608 JB 1H 103K-T	T	80.3/15.9
C1110	4030006900	S.CER C1608 JB 1H 103K-T	T	77.4/20.9
C1111	4030006900	S.CER C1608 JB 1H 103K-T	T	73/20.2
C1200	4030017810	S.CER C1608 CH 1H 102J-T	T	121/64.6
C1201	4030007050	S.CER C1608 CH 1H 220J-T	T	67.1/37.9
C1202	4030007140	S.CER C1608 CH 1H 121J-T	T	63.9/39.9
C1204	4030007070	S.CER C1608 CH 1H 330J-T	T	67.1/40.3
C1205	4030007080	S.CER C1608 CH 1H 390J-T	T	67.1/39.1
C1206	4030007090	S.CER C1608 CH 1H 470J-T	T	61/44.2
C1207	4030007080	S.CER C1608 CH 1H 390J-T	T	67.1/41.5

M.=Mounted side (T: Mounted on the Top side, B: Mounted on the Bottom side)

[RF-B UNIT]

REF NO.	ORDER NO.	DESCRIPTION	M.	H/V LOCATION
C1208	4030007100	S.CER C1608 CH 1H 560J-T	T	67.1/42.7
C1209	4030007030	S.CER C1608 CH 1H 150J-T	T	64.9/44.5
C1210	4030007100	S.CER C1608 CH 1H 560J-T	T	67.1/43.9
C1211	4030011600	S.CER C1608 JB 1E 104K-T	T	67.1/45.1
C1212	4030007030	S.CER C1608 CH 1H 150J-T	B	73.8/50.6
C1213	4030011600	S.CER C1608 JB 1E 104K-T	T	73.3/42.2
C1214	4030007020	S.CER C1608 CH 1H 120J-T	B	85.3/48.1
C1215	4030011600	S.CER C1608 JB 1E 104K-T	B	85.8/50.8
C1216	4030011600	S.CER C1608 JB 1E 104K-T	T	86.3/51.7
C1217	4030011600	S.CER C1608 JB 1E 104K-T	T	86.3/45.7
C1218	4030011600	S.CER C1608 JB 1E 104K-T	B	86.2/45.6
C1219	4030007030	S.CER C1608 CH 1H 150J-T	T	93/50.8
C1220	4030007030	S.CER C1608 CH 1H 150J-T	T	93/45.3
C1221	4030011600	S.CER C1608 JB 1E 104K-T	B	98/48.3
C1222	4030006880	S.CER C1608 JB 1H 472K-T	B	102.3/56.9
C1223	4030011340	S.CER C1608 CH 1H 471J-T	T	103.9/43.9
C1224	4030006880	S.CER C1608 JB 1H 472K-T	B	103/53
C1225	4030006880	S.CER C1608 JB 1H 472K-T	T	106.5/43.9
C1226	4030011340	S.CER C1608 CH 1H 471J-T	T	103.9/48.6
C1227	4030011600	S.CER C1608 JB 1E 104K-T	T	103.3/55.2
C1228	4030006880	S.CER C1608 JB 1H 472K-T	T	105.8/49.1
C1229	4030006880	S.CER C1608 JB 1H 472K-T	T	108.9/48.6
C1230	4030006880	S.CER C1608 JB 1H 472K-T	T	109.6/45.5
C1231	4030011600	S.CER C1608 JB 1E 104K-T	T	102.6/60.5
C1232	4550006080	S.TAN TEESVB2 1C 106M8L	T	101.7/62.8
C1233	4030006900	S.CER C1608 JB 1H 103K-T	T	109/56.3
C1234	4030006900	S.CER C1608 JB 1H 103K-T	T	114.5/53.2
C1235	4030011600	S.CER C1608 JB 1E 104K-T	T	111.1/57.2
C1236	4030009530	S.CER C1608 CH 1H 030B-T	T	110.3/54.6
C1237	4030007030	S.CER C1608 CH 1H 150J-T	T	114.5/46.1
C1238	4540000020	S.TRI TZY2Z060A001R00	T	109/56.3
C1239	4030011600	S.CER C1608 JB 1E 104K-T	B	114.8/65.2
C1240	4030007090	S.CER C1608 CH 1H 470J-T	B	100.3/51.8
C1241	4030011600	S.CER C1608 JB 1E 104K-T	B	93.2/59.7
C1242	4030007010	S.CER C1608 CH 1H 100D-T	B	100.7/59.7
C1301	4030006900	S.CER C1608 JB 1H 103K-T	T	95.4/58.3
C1302	4030006900	S.CER C1608 JB 1H 103K-T	B	99.1/64.7
C1303	4030006900	S.CER C1608 JB 1H 103K-T	T	95.6/63.6
C1304	4030007040	S.CER C1608 CH 1H 180J-T	T	92.8/59.7
C1305	4030006980	S.CER C1608 CH 1H 070D-T	T	91.8/62
C1306	4030008560	S.CER C1608 CH 1H 300J-T	T	91/58.6
C1307	4030007020	S.CER C1608 CH 1H 120J-T	T	89.1/59
C1308	4030007060	S.CER C1608 CH 1H 270J-T	T	91/59.8
C1309	4030017810	S.CER C1608 CH 1H 102J-T	T	82.5/63.3
C1310	4030011600	S.CER C1608 JB 1E 104K-T	T	71.1/57.8
C1311	4030006900	S.CER C1608 JB 1H 103K-T	T	75.9/58.6
C1312	4030006900	S.CER C1608 JB 1H 103K-T	T	73.5/58.6
C1313	4030006900	S.CER C1608 JB 1H 103K-T	T	79.9/64.3
C1314	4030006900	S.CER C1608 JB 1H 103K-T	B	70.1/61.2
C1400	4030011600	S.CER C1608 JB 1E 104K-T	T	129.9/84.2
C1401	4030011600	S.CER C1608 JB 1E 104K-T	T	54.5/38.1
C1402	4030011600	S.CER C1608 JB 1E 104K-T	T	50.7/37.6
C1403	4030011600	S.CER C1608 JB 1E 104K-T	T	52.9/41.9
C1404	4030011600	S.CER C1608 JB 1E 104K-T	T	54.8/42.4
C1405	4030007120	S.CER C1608 CH 1H 820J-T	T	54/44.3
C1406	4030007040	S.CER C1608 CH 1H 180J-T	T	51.4/48.6
C1407	4030007130	S.CER C1608 CH 1H 101J-T	T	54/48.6
C1408	4030007110	S.CER C1608 CH 1H 680J-T	T	53.6/50.5
C1409	4030007100	S.CER C1608 CH 1H 560J-T	T	54.1/52.4
C1451	4030007040	S.CER C1608 CH 1H 180J-T	T	77.8/71
C1452	4030009920	S.CER C1608 CH 1H 050B-T	T	82.6/71
C1453	4030011600	S.CER C1608 JB 1E 104K-T	B	86/72
C1454	4030011600	S.CER C1608 JB 1E 104K-T	B	91.1/68.2
C1501	4030006880	S.CER C1608 JB 1H 472K-T	T	100/73.8
C1502	4030006880	S.CER C1608 JB 1H 472K-T	T	100.1/72.6
C1550	4030017810	S.CER C1608 CH 1H 102J-T	T	125.1/62.5
C1551	4030007100	S.CER C1608 CH 1H 560J-T	T	95.5/69.6
C1552	4030006980	S.CER C1608 CH 1H 070D-T	T	97.3/69.1
C1553	4030007100	S.CER C1608 CH 1H 560J-T	T	99.2/69.6
C1556	4030006880	S.CER C1608 JB 1H 472K-T	T	115.5/67.9
C1557	4030007010	S.CER C1608 CH 1H 100D-T	T	115.5/70.6
C1558	4030011600	S.CER C1608 JB 1E 104K-T	T	121.5/67.9
C1559	4030006970	S.CER C1608 CH 1H 060D-T	T	120.3/67.9
C1560	4030017810	S.CER C1608 CH 1H 102J-T	T	116.7/67.9
C1561	4030017810	S.CER C1608 CH 1H 102J-T	T	125.2/70.6
C1563	4030017810	S.CER C1608 CH 1H 102J-T	T	128.8/72.1
C1601	4030007170	S.CER C1608 CH 1H 221J-T	T	121.7/55.5
C1602	4030006880	S.CER C1608 JB 1H 472K-T	T	119.6/50.1
C1603	4030006900	S.CER C1608 JB 1H 103K-T	T	122.2/57.3
C1604	4030006900	S.CER C1608 JB 1H 103K-T	T	122.2/58.5
C1651	4030009920	S.CER C1608		

[RF-B UNIT]

REF NO.	ORDER NO.	DESCRIPTION	M.	H/V LOCATION
C1758	4030006880	S.CER C1608 JB 1H 472K-T	T	136.9/49.8
C1759	4030011600	S.CER C1608 JB 1E 104K-T	T	144.3/79.6
C1760	4030006880	S.CER C1608 JB 1H 472K-T	T	139.8/81.8
C1761	4030011830	S.CER C1608 CH 1H 301J-T	T	148.1/84
C1762	4030011830	S.CER C1608 CH 1H 301J-T	T	151.5/81
C1763	4030011600	S.CER C1608 JB 1E 104K-T	T	153.9/83.6
C1801	4030006880	S.CER C1608 JB 1H 472K-T	T	154.8/31.4
C1802	4030007030	S.CER C1608 CH 1H 150J-T	T	154.1/37.2
C1803	4030006880	S.CER C1608 JB 1H 472K-T	T	153.4/34.1
C1804	4030006880	S.CER C1608 JB 1H 472K-T	T	152.6/46.2
C1805	4030011600	S.CER C1608 JB 1E 104K-T	T	150.5/28.9
C1851	4030011600	S.CER C1608 JB 1E 104K-T	T	151.1/54.7
C1852	4030011600	S.CER C1608 JB 1E 104K-T	T	154.8/51.7
C1853	4030011340	S.CER C1608 CH 1H 471J-T	T	153.4/64.1
C1854	4030011600	S.CER C1608 JB 1E 104K-T	B	156.3/73.1
C1855	4030011600	S.CER C1608 JB 1E 104K-T	B	153.8/69.1
C1856	4030011600	S.CER C1608 JB 1E 104K-T	T	153.4/74.2
C1857	4030011600	S.CER C1608 JB 1E 104K-T	T	150.1/76.6
C1858	4030011600	S.CER C1608 JB 1E 104K-T	B	155.4/81.8
C1901	4030011600	S.CER C1608 JB 1E 104K-T	T	144/21.7
C2001	4030006880	S.CER C1608 JB 1H 472K-T	B	129.5/88.8
C2002	4030006880	S.CER C1608 JB 1H 472K-T	B	92.4/88.1
C2003	4030017810	S.CER C1608 CH 1H 102J-T	B	135.7/90.5
C2004	4510004630	S.ELE ECEV1CA100SFR	T	131.8/89.7
C2005	4030011600	S.CER C1608 JB 1E 104K-T	B	95.7/91.3
C2006	4030011600	S.CER C1608 JB 1E 104K-T	B	98.5/89.3
C2007	4030017810	S.CER C1608 CH 1H 102J-T	T	93.1/95.8
C2008	4030006880	S.CER C1608 JB 1E 104K-T	T	91.9/95.8
C2009	4030006980	S.CER C1608 CH 1H 070D-T	T	90.7/95.8
C2010	4030011600	S.CER C1608 JB 1E 104K-T	B	132.8/88.8
C2011	4030011600	S.CER C1608 JB 1E 104K-T	B	124.2/94.9
C2012	4030007130	S.CER C1608 CH 1H 101J-T	T	84.9/82.5
C2013	4030007130	S.CER C1608 CH 1H 101J-T	T	127.8/88.4
C2014	4030017810	S.CER C1608 CH 1H 102J-T	T	128.8/76.9
C2102	4030006980	S.CER C1608 CH 1H 070D-T	B	76.9/81.1
C2103	4030006880	S.CER C1608 JB 1H 472K-T	B	77/85.4
C2104	4030006880	S.CER C1608 JB 1H 472K-T	B	70.4/79.6
C2201	4030007030	S.CER C1608 CH 1H 150J-T	B	106.5/79.9
C2202	4030006880	S.CER C1608 JB 1H 472K-T	B	101.5/76.9
C2203	4030017810	S.CER C1608 CH 1H 102J-T	T	112.6/85.2
C2204	4030009520	S.CER C1608 CH 1H 020B-T	T	116.2/84.6
C2205	4030007030	S.CER C1608 CH 1H 150J-T	B	118.3/80.1
C2206	4030006880	S.CER C1608 JB 1H 472K-T	B	119.3/77.5
C2207	4030017810	S.CER C1608 CH 1H 102J-T	T	119.1/83.4
C2208	4030007010	S.CER C1608 CH 1H 100D-T	T	121.2/81.1
C2209	4030006880	S.CER C1608 JB 1H 472K-T	T	121.2/77.6
C2210	4030006880	S.CER C1608 JB 1H 472K-T	T	124.9/82.1
C2211	4030006880	S.CER C1608 JB 1H 472K-T	T	128.3/81.6
C2212	4030008920	S.CER C1608 JB 1H 473K-T	T	130.1/82.1
C9001	4030006880	S.CER C1608 JB 1H 472K-T	T	4.6/59.4
C9002	4030006880	S.CER C1608 JB 1H 472K-T	T	7.4/59.4
C9007	4030006880	S.CER C1608 JB 1H 472K-T	T	42/38.9
C9008	4030006880	S.CER C1608 JB 1H 472K-T	T	42/36.1
C9011	4030006880	S.CER C1608 JB 1H 472K-T	T	26/82.4
C9012	4030006880	S.CER C1608 JB 1H 472K-T	T	26/79.6
C9015	4030006880	S.CER C1608 JB 1H 472K-T	T	54.6/67.5
C9016	4030006880	S.CER C1608 JB 1H 472K-T	T	57.4/67.4
C9018	4030006880	S.CER C1608 JB 1H 472K-T	T	20.6/17.5
C9020	4030006880	S.CER C1608 JB 1H 472K-T	T	23.4/17.5
C9021	4030006880	S.CER C1608 JB 1H 472K-T	T	49.4/17.5
C9024	4030006880	S.CER C1608 JB 1H 472K-T	T	46.6/17.5
C9026	4030006880	S.CER C1608 JB 1H 472K-T	T	44.1/42.9
C9027	4030006880	S.CER C1608 JB 1H 472K-T	T	44.1/40.1
RL101	6330001810	RLY ATN203		
RL102	6330001810	RLY ATN203		
RL103	6330001810	RLY ATN203		
J101	6510007020	CNR TMP-J01X-V6		
J102	6450001130	CNR JPJ2042-01-110		
J201	6510007020	CNR TMP-J01X-V6		
J451	6510019990	S.CNR 52808-2291	T	137.9/13
J801	6910016430	CNR IMSA-9210B-1-05Z869-PT1		
J802	6910016430	CNR IMSA-9210B-1-05Z869-PT1		
J803	6910016430	CNR IMSA-9210B-1-05Z869-PT1		
J804	6910016430	CNR IMSA-9210B-1-05Z869-PT1		
J805	6910016430	CNR IMSA-9210B-1-05Z869-PT1		
J807	6910016430	CNR IMSA-9210B-1-05Z869-PT1		
J809	6910016430	CNR IMSA-9210B-1-05Z869-PT1		
J951	6510007020	CNR TMP-J01X-V6		
J1101	6510007020	CNR TMP-J01X-V6		
J1301	6510007020	CNR TMP-J01X-V6		
J1651	6510007020	CNR TMP-J01X-V6		
J1801	6510007020	CNR TMP-J01X-V6		
J1851	6510007020	CNR TMP-J01X-V6		
J2001	6510006360	CNR TMP-J02X-A1		
J2101	6510007020	CNR TMP-J01X-V6		
W2101	9024801019	JMP 74/98/020/X98/X98		

M.=Mounted side (T: Mounted on the Top side, B: Mounted on the Bottom side)

[RF-B UNIT]

REF NO.	ORDER NO.	DESCRIPTION	M.	H/V LOCATION
EP1	0910058371	PCB B 6168A		
EP451	6910015970	S.BEA MMZ1608B 301CT-AS	T	146.4/18.3
EP452	6910015970	S.BEA MMZ1608B 301CT-AS	T	144.4/18.3
EP453	6910015970	S.BEA MMZ1608B 301CT-AS	T	140.1/18.4
EP454	6910015970	S.BEA MMZ1608B 301CT-AS	T	134.7/19.4
EP455	6910015970	S.BEA MMZ1608B 301CT-AS	T	133.5/19.4
EP456	6910015970	S.BEA MMZ1608B 301CT-AS	T	132.3/19.4
EP457	6910015970	S.BEA MMZ1608B 301CT-AS	T	131.1/19.4
EP458	6910015970	S.BEA MMZ1608B 301CT-AS	T	129/7.1
EP459	6910015970	S.BEA MMZ1608B 301CT-AS	T	126.6/7.1
EP460	6910015970	S.BEA MMZ1608B 301CT-AS	T	127.8/7.1
EP461	6910015970	S.BEA MMZ1608B 301CT-AS	T	148.3/19.4
EP462	6910015970	S.BEA MMZ1608B 301CT-AS	B	136.4/5.3
EP463	6910015970	S.BEA MMZ1608B 301CT-AS	T	120.1/6.7
EP464	6910015970	S.BEA MMZ1608B 301CT-AS	T	120.1/7.9
EP465	6910015970	S.BEA MMZ1608B 301CT-AS	T	120.1/9.1
EP466	6910015970	S.BEA MMZ1608B 301CT-AS	T	120.1/10.3
EP467	6910015970	S.BEA MMZ1608B 301CT-AS	T	138.5/5.2
EP468	6910015970	S.BEA MMZ1608B 301CT-AS	T	137.3/5.2
EP469	6910015970	S.BEA MMZ1608B 301CT-AS	T	141.9/7.6
EP470	6910015970	S.BEA MMZ1608B 301CT-AS	T	143.1/7.6
EP471	6910015970	S.BEA MMZ1608B 301CT-AS	T	142.8/19.6
EP472	6910015970	S.BEA MMZ1608B 301CT-AS	T	141.6/19.6
EP473	6910015970	S.BEA MMZ1608B 301CT-AS	T	130.2/4.5
EP1205	6910015970	S.BEA MMZ1608B 301CT-AS	T	121/63.4
EP1406	6910015970	S.BEA MMZ1608B 301CT-AS	T	50.7/44.3
EP1551	6910015970	S.BEA MMZ1608B 301CT-AS	T	125.1/63.7
EP1552	6910015970	S.BEA MMZ1608B 301CT-AS	T	127.6/72.1
EP1801	6910015970	S.BEA MMZ1608B 301CT-AS	T	150.5/31.5
EP2001	6910015970	S.BEA MMZ1608B 301CT-AS	T	124.8/88
EP2002	6910015970	S.BEA MMZ1608B 301CT-AS	T	130.7/79

[BPF-A UNIT]

REF NO.	ORDER NO.	DESCRIPTION	M.	H/V LOCATION
D3301	1750000580	S.DIO 1SV307 (TPH3)	B	33.9/45.3
D3302	1750000580	S.DIO 1SV307 (TPH3)	B	30.9/3.5
D3401	1750000580	S.DIO 1SV307 (TPH3)	B	21.7/44.3
D3402	1750000580	S.DIO 1SV307 (TPH3)	B	27.5/5.7
D3501	1750000580	S.DIO 1SV307 (TPH3)	B	36.5/48.4
D3502	1750000580	S.DIO 1SV307 (TPH3)	B	40.6/10.5
D3601	1750000580	S.DIO 1SV307 (TPH3)	B	26.6/41.6
D3602	1750000580	S.DIO 1SV307 (TPH3)	B	27.5/3.9
L3201	6180003540	COL SP0406-3R9K-6		
L3202	6180003580	COL SP0406-120K-6		
L3203	6180003580	COL SP0406-120K-6		
L3204	6180003540	COL SP0406-3R9K-6		
L3205	6180003580	COL SP0406-120K-6		
L3301	6180003550	COL SP0406-4R7K-6		
L3302	6180003560	COL SP0406-5R6K-6		
L3303	6180003560	COL SP0406-5R6K-6		
L3304	6180003550	COL SP0406-4R7K-6		
L3305	6180003560	COL SP0406-5R6K-6		
L3401	6180003410	COL SP0406-2R2K-6		
L3402	6180003510	COL SP0406-6R8K-6		
L3403	6180003510	COL SP0406-6R8K-6		
L3404	6180003410	COL SP0406-2R2K-6		
L3405	6180003510	COL SP0406-6R8K-6		
L3501	6180003410	COL SP0406-2R2K-6		
L3502	6180003570	COL SP0406-3R3K-6		
L3503	6180003570	COL SP0406-3R3K-6		
L3504	6180003410	COL SP0406-2R2K-6		
L3505	6180003570	COL SP0406-3R3K-6		
L3601	6180003390	COL SP0406-1R2K-6		
L3602	6180003490	COL SP0406-2R7K-6		
L3603	6180003490	COL SP0406-2R7K-6		
L3604	6180003390	COL SP0406-1R2K-6		
L3605	6180003490	COL SP0406-2R7K-6		
R3201	7030000260	S.RES MCR10EZJH 100 Ω (101)	B	54.2/39.5
R3202	7030000260	S.RES MCR10EZJH 100 Ω (101)	B	56.9/25.8
R3301	7030000260	S.RES MCR10EZJH 100 Ω (101)	B	31.3/39.2
R3302	7030000260	S.RES MCR10EZJH 100 Ω (101)	B	30.2/12.7
R3401	7030000260	S.RES MCR10EZJH 100 Ω (101)	B	6/32.5
R3402	7030000260	S.RES MCR10EZJH 100 Ω (101)	B	6/17.5
R3501	7030000260	S.RES MCR10EZJH 100 Ω (101)	B	47.4/42.4
R3502	7030000260	S.RES MCR10EZJH 100 Ω (101)	B	45.2/23.4
R3601	7030000260	S.RES MCR10EZJH 100 Ω (101)	B	22/40.5
R3602	7030000260	S.RES MCR10EZJH 100 Ω (101)	B	20.2/11.1
C3201	4030017810	S.CER C1608 CH 1H 102J-T	B	53.6/41.5

S.=Surface mount

[BPF-A UNIT]

REF NO.	ORDER NO.	DESCRIPTION	M.	H/V LOCATION
C3202	4030011600	S.CER C1608 JB 1E 104K-T	B	51.4/1.6
C3203	4030017810	S.CER C1608 CH 1H 102J-T	B	53.6/43.3
C3204	4030010760	S.CER C1608 CH 1H 331J-T	B	50.4/39.2
C3205	4030007140	S.CER C1608 CH 1H 121J-T	B	50.4/37.4
C3206	4030007160	S.CER C1608 CH 1H 181J-T	B	48/33.6
C3207	4030007060	S.CER C1608 CH 1H 270J-T	B	48/35.4
C3208	4030010760	S.CER C1608 CH 1H 331J-T	B	49.4/31.8
C3209	4030007090	S.CER C1608 CH 1H 470J-T	B	49.4/30
C3210	4030007160	S.CER C1608 CH 1H 181J-T	B	47.9/27.3
C3211	4030007060	S.CER C1608 CH 1H 270J-T	B	49.7/27.3
C3212	4030010760	S.CER C1608 CH 1H 331J-T	B	49.4/24.6
C3213	4030007140	S.CER C1608 CH 1H 121J-T	B	49.4/22.8
C3214	4030017810	S.CER C1608 CH 1H 102J-T	B	53/21.2
C3215	4030011600	S.CER C1608 JB 1E 104K-T	B	53/24.8
C3216	4030017810	S.CER C1608 CH 1H 102J-T	B	53/23
C3301	4030017800	S.CER C1608 CH 1H 561J-T	B	29.2/34.8
C3302	4030011600	S.CER C1608 JB 1E 104K-T	B	31.2/31.2
C3303	4030010760	S.CER C1608 CH 1H 331J-T	B	29.2/33
C3304	4030007080	S.CER C1608 CH 1H 390J-T	B	31.2/29.4
C3305	4030010760	S.CER C1608 CH 1H 331J-T	B	31.2/27.6
C3306	4030010760	S.CER C1608 CH 1H 331J-T	B	34.4/25
C3307	4030007100	S.CER C1608 CH 1H 560J-T	B	32.6/25
C3308	4030007090	S.CER C1608 CH 1H 470J-T	B	30/24.4
C3309	4030010760	S.CER C1608 CH 1H 331J-T	B	30/22.6
C3310	4030010760	S.CER C1608 CH 1H 331J-T	B	32.6/21.6
C3311	4030007100	S.CER C1608 CH 1H 560J-T	B	34.4/21.6
C3312	4030007080	S.CER C1608 CH 1H 390J-T	B	30/20.6
C3313	4030010760	S.CER C1608 CH 1H 331J-T	B	31.2/18.8
C3314	4030017800	S.CER C1608 CH 1H 561J-T	B	32.2/12.9
C3315	4030011600	S.CER C1608 JB 1E 104K-T	B	29.3/16.7
C3316	4030010760	S.CER C1608 CH 1H 331J-T	B	34/12.9
C3401	4030011330	S.CER C1608 CH 1H 391J-T	B	10.2/32
C3402	4030011600	S.CER C1608 JB 1E 104K-T	B	10.2/30.2
C3403	4030017800	S.CER C1608 CH 1H 561J-T	B	10.2/33.8
C3404	4030007160	S.CER C1608 CH 1H 181J-T	B	10.2/26.6
C3405	4030007070	S.CER C1608 CH 1H 330J-T	B	10.2/28.4
C3406	4030007120	S.CER C1608 CH 1H 820J-T	B	12.9/27.4
C3407	4030007030	S.CER C1608 CH 1H 150J-T	B	14.7/27.4
C3408	4030007140	S.CER C1608 CH 1H 121J-T	B	11.5/22.8
C3409	4030007100	S.CER C1608 CH 1H 560J-T	B	11.5/24.6
C3410	4030007120	S.CER C1608 CH 1H 820J-T	B	15.9/20.7
C3411	4030007030	S.CER C1608 CH 1H 150J-T	B	14.1/20.7
C3412	4030007160	S.CER C1608 CH 1H 181J-T	B	13.5/16.4
C3413	4030007070	S.CER C1608 CH 1H 330J-T	B	13.5/18.2
C3414	4030011330	S.CER C1608 CH 1H 391J-T	B	13.8/11.3
C3415	4030011600	S.CER C1608 JB 1E 104K-T	B	12/14.7
C3416	4030017800	S.CER C1608 CH 1H 561J-T	B	12/11.3
C3501	4030010760	S.CER C1608 CH 1H 331J-T	B	45.4/42.4
C3502	4030011600	S.CER C1608 JB 1E 104K-T	B	41.8/40.8
C3503	4030007150	S.CER C1608 CH 1H 151J-T	B	43.6/42.4
C3504	4030007060	S.CER C1608 CH 1H 270J-T	B	40.8/38.2
C3505	4030007150	S.CER C1608 CH 1H 151J-T	B	40.8/36.4
C3506	4030007140	S.CER C1608 CH 1H 121J-T	B	38/34.5
C3507	4030007060	S.CER C1608 CH 1H 270J-T	B	38/32.7
C3508	4030007010	S.CER C1608 CH 1H 100D-T	B	39.3/30.9
C3509	4030007150	S.CER C1608 CH 1H 151J-T	B	39.3/29.1
C3510	4030007140	S.CER C1608 CH 1H 121J-T	B	38.8/26.4
C3511	4030007060	S.CER C1608 CH 1H 270J-T	B	40.6/26.4
C3512	4030007060	S.CER C1608 CH 1H 270J-T	B	39.3/23.7
C3513	4030007150	S.CER C1608 CH 1H 151J-T	B	39.3/21.9
C3514	4030010760	S.CER C1608 CH 1H 331J-T	B	42.6/19.6
C3515	4030011600	S.CER C1608 JB 1E 104K-T	B	42.6/23.2
C3516	4030007150	S.CER C1608 CH 1H 151J-T	B	42.6/21.4
C3601	4030007170	S.CER C1608 CH 1H 221J-T	B	20.8/34.8
C3602	4030011600	S.CER C1608 JB 1E 104K-T	B	22/42.4
C3603	4030007170	S.CER C1608 CH 1H 221J-T	B	20.8/33
C3604	4030007130	S.CER C1608 CH 1H 101J-T	B	21.8/29.4
C3605	4030007050	S.CER C1608 CH 1H 220J-T	B	21.8/31.2
C3606	4030007080	S.CER C1608 CH 1H 390J-T	B	22/26.8
C3607	4030007070	S.CER C1608 CH 1H 330J-T	B	23.8/26.8
C3608	4030007120	S.CER C1608 CH 1H 820J-T	B	21.8/22.2
C3609	4030007050	S.CER C1608 CH 1H 220J-T	B	21.8/24
C3610	4030007080	S.CER C1608 CH 1H 390J-T	B	24.4/20.8
C3611	4030007070	S.CER C1608 CH 1H 330J-T	B	26.2/20.8
C3612	4030007130	S.CER C1608 CH 1H 101J-T	B	23/18.2
C3613	4030007050	S.CER C1608 CH 1H 220J-T	B	23/16.4
C3614	4030007170	S.CER C1608 CH 1H 221J-T	B	22.2/11.3
C3615	4030011600	S.CER C1608 JB 1E 104K-T	B	21.5/14.2
C3616	4030007170	S.CER C1608 CH 1H 221J-T	B	24/11.3
EP1	0910058290	PCB B 6169		

M.=Mounted side (T: Mounted on the Top side, B: Mounted on the Bottom side)

[PREAMP UNIT]

REF NO.	ORDER NO.	DESCRIPTION	M.	H/V LOCATION
Q4201	1530003850	S.TR 2SC5551F-TD	T	43.8/25.9
Q4202	1530003850	S.TR 2SC5551F-TD	T	36.3/14.4
Q4203	1590001960	S.TR XP4311 (TX)	T	21.1/11.1
Q4204	1590001960	S.TR XP4311 (TX)	T	21.1/8.6
Q4301	1590001960	S.TR XP4311 (TX)	T	23.3/26.7
Q4302	1530003850	S.TR 2SC5551F-TD	T	7.3/20.8
Q4303	1590001960	S.TR XP4311 (TX)	T	22.7/24
D4101	1750000580	S.DIO 1SV307 (TPH3)	T	44/32.5
D4102	1750000580	S.DIO 1SV307 (TPH3)	T	48.8/27.7
D4201	1750000580	S.DIO 1SV307 (TPH3)	T	37.8/33.2
D4202	1750000580	S.DIO 1SV307 (TPH3)	T	44.5/16.9
D4301	1750000580	S.DIO 1SV307 (TPH3)	T	35.1/33.6
D4302	1750000580	S.DIO 1SV307 (TPH3)	T	48.4/8.9
L4101	6200003220	S.COL NL 322522T-151J	T	49/34.9
L4201	6200003220	S.COL NL 322522T-151J	T	40.6/30.1
L4202	6140003800	COL LR-439	T	
L4203	6200009690	S.COL LQH43CN101K01L	T	37.7/19
L4204	6200009690	S.COL LQH43CN101K01L	T	25.4/9
L4205	6140003810	COL LR-440	T	
L4206	6140003810	COL LR-440	T	
L4207	6200009690	S.COL LQH43CN101K01L	T	31.6/9
L4208	6140003800	COL LR-439	T	
L4209	6200003220	S.COL NL 322522T-151J	B	44.3/14.6
L4210	6200007780	S.COL LQW2BHN12J01L	T	35/30.4
L4301	6200003220	S.COL NL 322522T-151J	T	19.2/27.9
L4302	6140004430	COL LR-500	T	
L4303	6140003900	COL LR-489	T	
L4304	6200003260	S.COL NL 322522T-101J	T	15.7/25.7
L4305	6200003220	S.COL NL 322522T-151J	T	17.1/13.9
R4101	7030003280	S.RES ERJ3GEYJ 470 V (47 Ω)	T	45.6/33.2
R4102	7030003280	S.RES ERJ3GEYJ 470 V (47 Ω)	T	46.8/33.2
R4201	7030003280	S.RES ERJ3GEYJ 470 V (47 Ω)	T	37.2/29.3
R4202	7030003280	S.RES ERJ3GEYJ 470 V (47 Ω)	T	42/18.3
R4203	7030003280	S.RES ERJ3GEYJ 470 V (47 Ω)	T	27.9/7.6
R4204	7030003440	S.RES ERJ3GEYJ 102 V (1 kΩ)	T	44.5/21.4
R4205	7030003440	S.RES ERJ3GEYJ 102 V (1 kΩ)	T	40.6/14.6
R4206	7030003490	S.RES ERJ3GEYJ 272 V (2.7 kΩ)	T	42.6/21
R4207	7030003490	S.RES ERJ3GEYJ 272 V (2.7 kΩ)	T	39.9/16.5
R4208	7030003280	S.RES ERJ3GEYJ 470 V (47 Ω)	T	43.8/14.7
R4209	7030003220	S.RES ERJ3GEYJ 150 V (15 Ω)	B	37.2/25.1
R4210	7030003220	S.RES ERJ3GEYJ 150 V (15 Ω)	B	28.7/17.6
R4213	7030003280	S.RES ERJ3GEYJ 470 V (47 Ω)	T	40.6/22.9
R4214	7030003280	S.RES ERJ3GEYJ 470 V (47 Ω)	T	33.1/13.9
R4301	7030003280	S.RES ERJ3GEYJ 470 V (47 Ω)	T	21.4/29.8
R4302	7030003510	S.RES ERJ3GEYJ 392 V (3.9 kΩ)	T	12.3/27.2
R4303	7030003440	S.RES ERJ3GEYJ 102 V (1 kΩ)	T	12.3/24.8
R4304	7030007860	S.RES ERJ3GEYJ 8R2V (8.2 Ω)	T	2.3/20.8
R4305	7030003240	S.RES ERJ3GEYJ 220 V (22 Ω)	T	11.5/29.1
R4306	7030003280	S.RES ERJ3GEYJ 470 V (47 Ω)	T	15.4/11.9
R4307	7030003200	S.RES ERJ3GEYJ 100 V (10 Ω)	T	14.3/30.1
R4308	7030003280	S.RES ERJ3GEYJ 470 V (47 Ω)	B	7.1/27.9
R4309	7030003860	S.RES ERJ3GE JPW V	T	3.7/22.1
C4101	4030011600	S.CER C1608 JB 1E 104K-T	T	51.1/35.6
C4102	4030011600	S.CER C1608 JB 1E 104K-T	T	46.1/31.3
C4201	4030011600	S.CER C1608 JB 1E 104K-T	T	29.9/29.4
C4202	4030011600	S.CER C1608 JB 1E 104K-T	T	44.1/29.8
C4205	4030011600	S.CER C1608 JB 1E 104K-T	B	33.9/25.1
C4206	4030011600	S.CER C1608 JB 1E 104K-T	T	26.7/20.4
C4207	4030011600	S.CER C1608 JB 1E 104K-T	T	46.9/24.3
C4208	4030011600	S.CER C1608 JB 1E 104K-T	T	39.4/14.6
C4209	4030011600	S.CER C1608 JB 1E 104K-T	T	33.2/20.4
C4210	4030011600	S.CER C1608 JB 1E 104K-T	T	28.6/11
C4211	4030011600	S.CER C1608 JB 1E 104K-T	B	39/17.5
C4212	4030011600	S.CER C1608 JB 1E 104K-T	B	34.5/10.2
C4213	4030011600	S.CER C1608 JB 1E 104K-T	T	34.1/9.4
C4214	4030011600	S.CER C1608 JB 1E 104K-T	T	34.9/7
C4215	4030011600	S.CER C1608 JB 1E 104K-T	T	43.8/13.5
C4216	4030011600	S.CER C1608 JB 1E 104K-T	B	44.9/17.6
C4217	4030007110	S.CER C1608 CH 1H 680J-T	T	37.2/31.7
C4218	4030007110	S.CER C1608 CH 1H 680J-T	T	37.2/30.5
C4221	4030009510	S.CER C1608 CH 1H 010B-T	T	42.6/22.2
C4222	4030009510	S.CER C1608 CH 1H 010B-T	T	38.1/11.6
C4223	4030007010	S.CER C1608 CH 1H 100D-T	B	38.5/9.5
C4301	4030011600	S.CER C1608 JB 1E 104K-T	T	21.3/27.2
C4302	4030011600	S.CER C1608 JB 1E 104K-T	T	17.3/30.8
C4303	4030011600	S.CER C1608 JB 1E 104K-T	T	12.3/26
C4304	4030011600	S.CER C1608 JB 1E 104K-T	T	12.7/29.1
C4305	4030011600	S.CER C1608 JB 1E 104K-T	T	11.6/22.8
C4306	4030011600	S.CER C1608 JB 1E 104K-T	T	14.5/15.2
C4307	4030011600	S.CER C1608 JB 1E 104K-T	T	20.7/24.2
C4308	4030011600	S.CER C1608 JB 1E 104K-T	T	18/11.9
C4309	4030006990	S.CER C1608 CH 1H 080D-T	T	15.5/28.6
EP1	0910058301	PCB B 6185A		

S.=Surface mount

[TUNER-A UNIT]

REF NO.	ORDER NO.	DESCRIPTION	M.	H/V LOCATION
IC1	1120000970	IC M54562P		
IC2	1120000970	IC M54562P		
L1	2040000490	COL EXC-ELDR25C		
L2	2040000490	COL EXC-ELDR25C		
L3	6110003600	COL LA-555		
L4	6110003590	COL LA-554		
L5	6110003020	COL LA-489		
L6	6110003030	COL LA-490		
L7	6110003020	COL LA-489		
L8	6110003030	COL LA-490		
L9	6140004520	COL LR-511		
L10	6140004510	COL LR-510		
L11	6140002700	COL LR-307 (T130-2)		
L12	6140002700	COL LR-307 (T130-2)		
L13	6180003290	COL BM27-400-6A		
L14	6180003290	COL BM27-400-6A		
L15	6180003290	COL BM27-400-6A		
L16	6180003290	COL BM27-400-6A		
L17	6180003290	COL BM27-400-6A		
L18	6180003290	COL BM27-400-6A		
L19	6180003290	COL BM27-400-6A		
L20	6180003290	COL BM27-400-6A		
R17	7030003440	S.RES ERJ3GEYJ 102 V (1 kΩ)	T	118.6/75.9
R18	7030003440	S.RES ERJ3GEYJ 102 V (1 kΩ)	T	113.2/75.9
R19	7030003440	S.RES ERJ3GEYJ 102 V (1 kΩ)	T	107.8/75.9
R20	7030003440	S.RES ERJ3GEYJ 102 V (1 kΩ)	T	124.4/83.5
R21	7030003440	S.RES ERJ3GEYJ 102 V (1 kΩ)	T	101.8/73.1
R22	7030003440	S.RES ERJ3GEYJ 102 V (1 kΩ)	T	104.8/75.9
R23	7030003440	S.RES ERJ3GEYJ 102 V (1 kΩ)	T	101.8/75.9
R24	7030003440	S.RES ERJ3GEYJ 102 V (1 kΩ)	T	98.8/75.9
R25	7030003440	S.RES ERJ3GEYJ 102 V (1 kΩ)	T	81.6/75.1
R26	7030003440	S.RES ERJ3GEYJ 102 V (1 kΩ)	T	78.6/75.1
R27	7030003440	S.RES ERJ3GEYJ 102 V (1 kΩ)	T	75.6/75.1
R28	7030003440	S.RES ERJ3GEYJ 102 V (1 kΩ)	T	72.6/75.1
R29	7030003440	S.RES ERJ3GEYJ 102 V (1 kΩ)	T	69.6/75.1
R30	7030003440	S.RES ERJ3GEYJ 102 V (1 kΩ)	T	66.6/75.1
R31	7030003440	S.RES ERJ3GEYJ 102 V (1 kΩ)	T	63.6/75.1
R32	7030003440	S.RES ERJ3GEYJ 102 V (1 kΩ)	T	60.6/75.1
R33	7030003440	S.RES ERJ3GEYJ 102 V (1 kΩ)	T	63.7/94.5
R34	7030003440	S.RES ERJ3GEYJ 102 V (1 kΩ)	T	66.3/92.8
R35	7030003440	S.RES ERJ3GEYJ 102 V (1 kΩ)	T	68.9/93.4
R36	7030003440	S.RES ERJ3GEYJ 102 V (1 kΩ)	T	71.3/96.2
R37	7030003440	S.RES ERJ3GEYJ 102 V (1 kΩ)	T	73.9/96.8
R38	7030003440	S.RES ERJ3GEYJ 102 V (1 kΩ)	T	76.5/97.5
R39	7030003440	S.RES ERJ3GEYJ 102 V (1 kΩ)	T	80.3/96.3
R40	7030003440	S.RES ERJ3GEYJ 102 V (1 kΩ)	T	83/96.7
R41	7030003440	S.RES ERJ3GEYJ 102 V (1 kΩ)	T	115.5/90.1
R42	7030003440	S.RES ERJ3GEYJ 102 V (1 kΩ)	T	114.2/90.1
R43	7030003440	S.RES ERJ3GEYJ 102 V (1 kΩ)	T	109.4/97.5
R44	7030003440	S.RES ERJ3GEYJ 102 V (1 kΩ)	T	109.9/88.8
R45	7030003440	S.RES ERJ3GEYJ 102 V (1 kΩ)	T	107.4/97.5
R46	7030003440	S.RES ERJ3GEYJ 102 V (1 kΩ)	T	104.8/89.3
R47	7030003440	S.RES ERJ3GEYJ 102 V (1 kΩ)	T	105.7/97.5
C1	4030006880	S.CER C1608 JB 1H 472K-T	T	118.6/74.5
C2	4030006880	S.CER C1608 JB 1H 472K-T	T	113.2/74.5
C3	4030006880	S.CER C1608 JB 1H 472K-T	T	107.8/74.5
C4	4030006880	S.CER C1608 JB 1H 472K-T	T	124.4/82.1
C5	4030006880	S.CER C1608 JB 1H 472K-T	T	101.8/71.7
C6	4030006880	S.CER C1608 JB 1H 472K-T	T	104.8/74.5
C7	4030006880	S.CER C1608 JB 1H 472K-T	T	101.8/74.5
C8	4030006880	S.CER C1608 JB 1H 472K-T	T	98.8/74.5
C9	4030006880	S.CER C1608 JB 1H 472K-T	T	81.6/73.7
C10	4030006880	S.CER C1608 JB 1H 472K-T	T	78.6/73.7
C11	4030006880	S.CER C1608 JB 1H 472K-T	T	75.6/73.7
C12	4030006880	S.CER C1608 JB 1H 472K-T	T	72.6/73.7
C13	4030006880	S.CER C1608 JB 1H 472K-T	T	69.6/73.7
C14	4030006880	S.CER C1608 JB 1H 472K-T	T	66.6/73.7
C15	4030006880	S.CER C1608 JB 1H 472K-T	T	63.6/73.7
C16	4030006880	S.CER C1608 JB 1H 472K-T	T	60.6/73.7
C17	4030006880	S.CER C1608 JB 1H 472K-T	T	96.4/87.5
C18	4030006880	S.CER C1608 JB 1H 472K-T	T	61/88.3
C23	4030006880	S.CER C1608 JB 1H 472K-T	T	111.6/5.4
C24	4030006880	S.CER C1608 JB 1H 472K-T	T	105.3/5.4
C25	4030006880	S.CER C1608 JB 1H 472K-T	T	102.7/5.4
C26	4030006880	S.CER C1608 JB 1H 472K-T	T	119.6/5.4
C27	4030006880	S.CER C1608 JB 1H 472K-T	T	77.6/55.5
C28	4030006880	S.CER C1608 JB 1H 472K-T	T	72.1/55.5
C29	4030006880	S.CER C1608 JB 1H 472K-T	T	66.6/55.5
C30	4030006880	S.CER C1608 JB 1H 472K-T	T	61.1/55.5
C31	4030006880	S.CER C1608 JB 1H 472K-T	T	56.6/55.5
C32	4030006880	S.CER C1608 JB 1H 472K-T	T	51.1/55.5
C33	4030006880	S.CER C1608 JB 1H 472K-T	T	47.8/76.1
C34	4010008550	CER DEA1X3F390JC3B		
C35	4010008550	CER DEA1X3F390JC3B		
C36	4010004800	CER DEC1X3J820JC4B		
C37	4010004250	CER DE1007 SL 101J 3KV		
C38	4010004830	CER DEC1X3J151JC4B		

M.=Mounted side (T: Mounted on the Top side, B: Mounted on the Bottom side)

[TUNER-A UNIT]

REF NO.	ORDER NO.	DESCRIPTION	M.	H/V LOCATION
C39	4010008560	CER DEA1X3F151JA3B		
C40	4010004250	CER DE1007 SL 101J 3KV		
C41	4010004250	CER DE1007 SL 101J 3KV		
C42	4010004250	CER DE1007 SL 101J 3KV		
C43	4010004250	CER DE1007 SL 101J 3KV		
C44	4620000140	VAR UV35A 150P		
C45	4620000140	VAR UV35A 150P		
C46	4030006880	S.CER C1608 JB 1H 472K-T	T	117.4/88.9
C47	4030006880	S.CER C1608 JB 1H 472K-T	T	117.4/87.5
C48	4030006880	S.CER C1608 JB 1H 472K-T	T	114.4/87.5
C49	4030006880	S.CER C1608 JB 1H 472K-T	T	111.4/87.5
C50	4030006880	S.CER C1608 JB 1H 472K-T	T	108.4/87.5
C51	4030006880	S.CER C1608 JB 1H 472K-T	T	105.4/87.5
C52	4030006880	S.CER C1608 JB 1H 472K-T	T	102.4/87.5
C53	4030006880	S.CER C1608 JB 1H 472K-T	T	99.4/87.5
C54	4030006880	S.CER C1608 JB 1H 472K-T	T	81/88.3
C55	4030006880	S.CER C1608 JB 1H 472K-T	T	78.6/88.3
C56	4030006880	S.CER C1608 JB 1H 472K-T	T	76.2/88.3
C57	4030006880	S.CER C1608 JB 1H 472K-T	T	73.4/88.3
C58	4030006880	S.CER C1608 JB 1H 472K-T	T	71/88.3
C59	4030006880	S.CER C1608 JB 1H 472K-T	T	68.6/88.3
C60	4030006880	S.CER C1608 JB 1H 472K-T	T	66.2/88.3
C61	4030006880	S.CER C1608 JB 1H 472K-T	T	63.4/88.3
C62	4030006880	S.CER C1608 JB 1H 472K-T	T	44.6/54.6
RL1	6330001610	RLY NY-12W-K-IE		
RL2	6330001610	RLY NY-12W-K-IE		
RL3	6330001610	RLY NY-12W-K-IE		
RL4	6330001610	RLY NY-12W-K-IE		
RL5	6330001610	RLY NY-12W-K-IE		
RL6	6330001610	RLY NY-12W-K-IE		
RL7	6330001610	RLY NY-12W-K-IE		
RL8	6330001610	RLY NY-12W-K-IE		
RL9	6330001610	RLY NY-12W-K-IE		
RL10	6330001610	RLY NY-12W-K-IE		
RL11	6330001610	RLY NY-12W-K-IE		
RL12	6330001610	RLY NY-12W-K-IE		
RL13	6330001610	RLY NY-12W-K-IE		
RL14	6330001610	RLY NY-12W-K-IE		
RL15	6330001610	RLY NY-12W-K-IE		
RL16	6330001610	RLY NY-12W-K-IE		
J5	6510019990	S.CNR 52808-2291	T	102.9/93.3
MF1	2710000460	MTR MP28GA STEPPING MOTOR		
MF2	2710000460	MTR MP28GA STEPPING MOTOR		
EP1	0910058501	PCB B 6211A		

[CTRL-A UNIT]

REF NO.	ORDER NO.	DESCRIPTION	M.	H/V LOCATION
IC1	1110000960	S.IC NJM4558M-TE1	T	111.8/54.9
IC2	1120002250	S.IC TC74ACT32F	T	121.5/68.8
IC3	1120002240	S.IC TC74AC112F	T	131.7/69
IC4	1110000960	S.IC NJM4558M-TE1	T	116.6/80.8
IC5	1140004120	S.IC M38022M2-138FP	T	154/70.6
IC6	1130010390	S.IC HN58X2416TI	T	140.6/76
IC9	1110002690	S.IC NJM2903M-TE1	T	44.2/21.8
IC10	1130003920	S.IC TC4S69F (TE85R)	T	151.8/48
IC11	1130011530	S.IC CD74HC4094M96	T	146.4/28.4
IC12	1160000130	S.IC TD62783AF (S,EL)	T	134/28
IC13	1180001070	S.IC TA7805F (TE16L)	T	159.6/42.4
IC14	1120002300	S.IC TC74AC04F	T	104/68.5
IC51	1130011530	S.IC CD74HC4094M96	T	118.6/29.4
Q5	1560000870	S.FET 2SK515-T1B (X33)	T	104.2/80.2
Q12	1590000680	S.TR DTC114EUA T106	T	68/80.6
Q13	1590001330	S.TR DTA114EUA T106	T	68/78
Q14	1590000680	S.TR DTC114EUA T106	T	37.2/63
Q15	1590001330	S.TR DTA114EUA T106	T	39.8/63
Q16	1590000680	S.TR DTC114EUA T106	T	37.2/49.2
Q17	1590001330	S.TR DTA114EUA T106	T	39.8/49.2
Q21	1590000680	S.TR DTC114EUA T106	T	11.7/13
Q22	1590001330	S.TR DTA114EUA T106	T	14.2/13
Q23	1590000680	S.TR DTC114EUA T106	T	166.6/61.1
Q24	1590001330	S.TR DTA114EUA T106	T	166.9/64.1
Q25	1530003090	S.TR 2SC4213-B (TE85R)	T	43.2/93.2

S.=Surface mount

[CTRL-A UNIT]

REF NO.	ORDER NO.	DESCRIPTION	M.	H/V LOCATION
Q26	1590000680	S.TR DTC114EUA T106	T	14.2/9.5
Q27	1590001330	S.TR DTA114EUA T106	T	11.7/9.5
Q51	1590000680	S.TR DTC114EUA T106	T	154.9/85.2
Q52	1590000680	S.TR DTC114EUA T106	T	155.8/87.9
Q59	1590000680	S.TR DTC114EUA T106	T	174.4/50.5
Q211	1590000680	S.TR DTC114EUA T106	T	187.5/77.6
Q212	1590000680	S.TR DTC114EUA T106	T	185/76.6
Q213	1590000680	S.TR DTC114EUA T106	T	182.5/76.6
Q214	1590000680	S.TR DTC114EUA T106	T	180/76.6
Q215	1590000680	S.TR DTC114EUA T106	T	177.3/88.2
Q216	1590000680	S.TR DTC114EUA T106	T	179.8/88.2
Q217	1590000680	S.TR DTC114EUA T106	T	182.3/88.2
Q218	1590000680	S.TR DTC114EUA T106	T	184.8/88.2
D1	1790000490	S.DIO HSM88AS-TR	T	96/49
D2	1790000490	S.DIO HSM88AS-TR	T	96/60.7
D3	1750000200	S.DIO 1SS319 (TE85R)	T	120.5/45.7
D4	1750000120	S.DIO DWA010-TE	T	104.4/61.8
D5	1790000690	S.DIO HSM88ASR-TR	T	102.5/74.8
D6	1790000490	S.DIO HSM88AS-TR	T	127.9/84.6
D7	1790000490	S.DIO HSM88AS-TR	T	128.2/78.7
D8	1790000490	S.DIO HSM88AS-TR	T	97.4/78.8
D9	1790000490	S.DIO HSM88AS-TR	T	97.4/82.2
D11	1730000410	S.ZEN RD5.1M-T2B2	T	166.6/48
D12	1730000030	S.ZEN RD5.6M-T2B2	T	161.4/48
D13	1710000780	S.DIO MA114 (TX)	T	167.5/44.6
D15	1790000490	S.DIO HSM88AS-TR	T	36.9/25.8
D16	1750000270	S.DIO 1SS301 (TE85R)	T	67.9/74
D17	1750000270	S.DIO 1SS301 (TE85R)	T	42.4/63
D18	1750000270	S.DIO 1SS301 (TE85R)	T	42.4/49.2
D20	1750000270	S.DIO 1SS301 (TE85R)	T	13.8/15.7
D22	1750000850	S.DIO MMBV3700LT1	T	49.4/94.7
D23	1750000850	S.DIO MMBV3700LT1	T	46.4/96.1
D24	1750000120	S.DIO DWA010-TE	T	151.4/84.9
D25	1750000120	S.DIO DWA010-TE	T	152.5/88.4
D211	1750000200	S.DIO 1SS319 (TE85R)	T	186.3/73.1
D213	1750000200	S.DIO 1SS319 (TE85R)	T	182.8/73
D215	1750000200	S.DIO 1SS319 (TE85R)	T	179.3/84.7
D217	1750000200	S.DIO 1SS319 (TE85R)	T	182.8/84.7
D218	1750000120	S.DIO DWA010-TE	T	121.5/86.6
X1	6050009890	S.XTL CR-569 (6.144 MHz)	T	171.3/67.7
L1	6140003270	COL LR-364		
L2	6200001830	S.COL NL 322522T-100J	T	123.8/51.8
L3	6200003260	S.COL NL 322522T-101J	T	127.8/51.7
L4	6140003270	COL LR-364		
L5	6180001220	COL LAL 04NA 100K		
L8	6140003270	COL LR-364		
L9	6180003300	COL T6-222J (2.2M)		
L10	6200003260	S.COL NL 322522T-101J	T	139.7/62.5
L11	6200003260	S.COL NL 322522T-101J	T	142/66.2
L13	6180000990	COL LAL 04NA 101K		
L22	6140003270	COL LR-364		
L25	6200003260	S.COL NL 322522T-101J	T	55.9/18.4
L27	6110001630	COL LA-246		
L28	6110001560	COL LA-236		
L29	2040000490	COL EXC-ELDR25C		
L30	2040000490	COL EXC-ELDR25C		
L31	2040000490	COL EXC-ELDR25C		
L32	2040000490	COL EXC-ELDR25C		
L33	6200003260	S.COL NL 322522T-101J	T	141.8/39
L34	6200003260	S.COL NL 322522T-101J	T	129.3/38.8
L35	6200003950	S.COL HF50ACC 322513-T	T	141.9/10.6
L36	6200003950	S.COL HF50ACC 322513-T	T	141.7/7.6
L301	6140002580	COL LR-295 (T50-2)		
L302	6140002580	COL LR-295 (T50-2)		
L303	6200003260	S.COL NL 322522T-101J	T	122.3/22.9
R1	7030010910	S.RES ERJ1TYJ 150U (15 Ω)	T	95.8/52.7
R2	7030010910	S.RES ERJ1TYJ 150U (15 Ω)	T	95.8/56.8
R3	7030003560	S.RES ERJ3GEYJ 103 V (10 kΩ)	T	103.6/49
R4	7030003560	S.RES ERJ3GEYJ 103 V (10 kΩ)	T	100.9/59.9
R5	7030003720	S.RES ERJ3GEYJ 224 V (220 kΩ)	T	106/49.8
R6	7030003720	S.RES ERJ3GEYJ 224 V (220 kΩ)	T	106.1/57.9
R7	7030003720	S.RES ERJ3GEYJ 224 V (220 kΩ)	T	107.4/51.2
R8	7030003720	S.RES ERJ3GEYJ 224 V (220 kΩ)	T	108/57.9
R9	7030003800	S.RES ERJ3GEYJ 105 V (1 MΩ)	T	111.6/50.2
R10	7030003790	S.RES ERJ3GEYJ 824 V (820 kΩ)	T	112.4/60.8
R11	7030003860	S.RES ERJ3GE JPW V	T	149/44.9
R13	7030003440	S.RES ERJ3GEYJ 102 V (1 kΩ)	T	117.1/47.9
R14	7030003440	S.RES ERJ3GEYJ 102 V (1 kΩ)	T	117.2/43.8
R15	7030003320	S.RES ERJ3GEYJ 101 V (100 Ω)	T	107.4/61.7
R16	7030010540	S.RES ERJ1TYJ 330U (33 Ω)	T	92.4/69.8
R17	7030003320	S.RES ERJ3GEYJ 101 V (100 Ω)	T	105/74.6
R26	7030003280	S.RES ERJ3GEYJ 470 V (47 Ω)	T	130.8/78.2
R27	7030003280	S.RES ERJ3GEYJ 470 V (47 Ω)	T	128/75.2
R28	7030003500	S.RES ERJ3GEYJ 332 V (3.3 kΩ)	T	128/82.5
R29	7030003480	S.RES ERJ3GEYJ 222 V (2.2 kΩ)	T	128/76.5

M.=Mounted side (T: Mounted on the Top side, B: Mounted on the Bottom side)

[CTRL-A UNIT]

REF NO.	ORDER NO.	DESCRIPTION	M.	H/V LOCATION
R30	7030003360	S.RES ERJ3GEYJ 221 V (220 Ω)	T	128/81.2
R31	7030003480	S.RES ERJ3GEYJ 222 V (2.2 kΩ)	T	122.8/83.2
R32	7030003680	S.RES ERJ3GEYJ 104 V (100 kΩ)	T	124.9/81.2
R33	7030003530	S.RES ERJ3GEYJ 562 V (5.6 kΩ)	T	120.2/76.3
R34	7030003530	S.RES ERJ3GEYJ 562 V (5.6 kΩ)	T	118.8/76.3
R35	7030003670	S.RES ERJ3GEYJ 823 V (82 kΩ)	T	117.4/76.3
R36	7030003820	S.RES ERJ3GEYJ 155 V (1.5 MΩ)	T	122/81.2
R37	7030003560	S.RES ERJ3GEYJ 103 V (10 kΩ)	T	118.3/85.8
R38	7030003560	S.RES ERJ3GEYJ 103 V (10 kΩ)	T	124.8/87.7
R39	7030003680	S.RES ERJ3GEYJ 104 V (100 kΩ)	T	142.8/62.4
R40	7030003680	S.RES ERJ3GEYJ 104 V (100 kΩ)	T	142.8/63.8
R41	7030010550	S.RES ERJ1TYJ 820U (82 Ω)	T	92.4/81.7
R42	7030003560	S.RES ERJ3GEYJ 103 V (10 kΩ)	T	100.8/78.6
R43	7030003560	S.RES ERJ3GEYJ 103 V (10 kΩ)	T	100.8/82.7
R44	7030003800	S.RES ERJ3GEYJ 105 V (1 MΩ)	T	100.8/79.9
R45	7030003560	S.RES ERJ3GEYJ 103 V (10 kΩ)	T	103.8/82.7
R46	7030003520	S.RES ERJ3GEYJ 472 V (4.7 kΩ)	T	107.4/83.5
R47	7030003440	S.RES ERJ3GEYJ 102 V (1 kΩ)	T	108.2/81.2
R48	7030003560	S.RES ERJ3GEYJ 103 V (10 kΩ)	T	109/83.5
R49	7030003680	S.RES ERJ3GEYJ 104 V (100 kΩ)	T	111.2/81.6
R50	7030003540	S.RES ERJ3GEYJ 682 V (6.8 kΩ)	T	114/76.3
R51	7030003540	S.RES ERJ3GEYJ 682 V (6.8 kΩ)	T	112.6/76.3
R52	7030003680	S.RES ERJ3GEYJ 104 V (100 kΩ)	T	115.3/84.5
R53	7030003820	S.RES ERJ3GEYJ 155 V (1.5 MΩ)	T	111.8/83.5
R54	7030003560	S.RES ERJ3GEYJ 103 V (10 kΩ)	T	113.9/85.8
R55	7030003560	S.RES ERJ3GEYJ 103 V (10 kΩ)	T	124.8/89.1
R56	7030003680	S.RES ERJ3GEYJ 104 V (100 kΩ)	T	142.8/61.1
R57	7030003680	S.RES ERJ3GEYJ 104 V (100 kΩ)	T	142.8/59.8
R58	7540000130	ASB 2P-50A-301		
R59	7030003560	S.RES ERJ3GEYJ 103 V (10 kΩ)	T	141/71.4
R60	7030003560	S.RES ERJ3GEYJ 103 V (10 kΩ)	T	141/70
R61	7030003680	S.RES ERJ3GEYJ 104 V (100 kΩ)	T	151.2/59.4
R62	7030003680	S.RES ERJ3GEYJ 104 V (100 kΩ)	T	152.6/59.4
R63	7030003680	S.RES ERJ3GEYJ 104 V (100 kΩ)	T	154/59.4
R64	7030003680	S.RES ERJ3GEYJ 104 V (100 kΩ)	T	149.8/59.4
R65	7030003440	S.RES ERJ3GEYJ 102 V (1 kΩ)	T	169.8/47.2
R66	7030003650	S.RES ERJ3GEYJ 563 V (56 kΩ)	T	157.4/48
R67	7030003440	S.RES ERJ3GEYJ 102 V (1 kΩ)	T	149.2/48
R69	7030003320	S.RES ERJ3GEYJ 101 V (100 Ω)	T	152/45.7
R71	7030003440	S.RES ERJ3GEYJ 102 V (1 kΩ)	T	168.6/59.4
R76	7030003560	S.RES ERJ3GEYJ 103 V (10 kΩ)	T	162.1/59.7
R83	7030010910	S.RES ERJ1TYJ 150U (15 Ω)	T	35/29.3
R84	7030003560	S.RES ERJ3GEYJ 103 V (10 kΩ)	T	34.5/24.5
R86	7030003710	S.RES ERJ3GEYJ 184 V (180 kΩ)	T	49.2/24.2
R87	7030003660	S.RES ERJ3GEYJ 683 V (68 kΩ)	T	50.6/24.2
R88	7030003660	S.RES ERJ3GEYJ 683 V (68 kΩ)	T	51.4/20.6
R89	7030003840	S.RES ERJ3GEYJ 225 V (2.2 MΩ)	T	51.4/19.2
R90	7030003720	S.RES ERJ3GEYJ 224 V (220 kΩ)	T	61.5/21.1
R92	7030003440	S.RES ERJ3GEYJ 102 V (1 kΩ)	T	49.2/18.2
R93	7030003560	S.RES ERJ3GEYJ 103 V (10 kΩ)	T	51.4/17.8
R98	7030003440	S.RES ERJ3GEYJ 102 V (1 kΩ)	T	157.2/16.8
R99	7030003560	S.RES ERJ3GEYJ 103 V (10 kΩ)	T	155.8/16.8
R100	7030003660	S.RES ERJ3GEYJ 683 V (68 kΩ)	T	106/52.8
R101	7030003660	S.RES ERJ3GEYJ 683 V (68 kΩ)	T	106.9/55.8
R102	7030003570	S.RES ERJ3GEYJ 123 V (12 kΩ)	T	155.2/47.2
R103	7030003680	S.RES ERJ3GEYJ 104 V (100 kΩ)	T	155.2/48.6
R105	7030003440	S.RES ERJ3GEYJ 102 V (1 kΩ)	T	158.8/58.9
R106	7030003440	S.RES ERJ3GEYJ 102 V (1 kΩ)	T	160.2/58.9
R107	7030003680	S.RES ERJ3GEYJ 104 V (100 kΩ)	T	170/59.4
R108	7030003440	S.RES ERJ3GEYJ 102 V (1 kΩ)	T	150.8/92.2
R109	7030003440	S.RES ERJ3GEYJ 102 V (1 kΩ)	T	150.8/90.8
R110	7030003440	S.RES ERJ3GEYJ 102 V (1 kΩ)	T	159.4/83.6
R111	7030003440	S.RES ERJ3GEYJ 102 V (1 kΩ)	T	137.2/95.1
R112	7030003440	S.RES ERJ3GEYJ 102 V (1 kΩ)	T	158.2/83.6
R113	7030003440	S.RES ERJ3GEYJ 102 V (1 kΩ)	T	150.1/88.7
R114	7030003440	S.RES ERJ3GEYJ 102 V (1 kΩ)	T	154.8/83.3
R115	7030003440	S.RES ERJ3GEYJ 102 V (1 kΩ)	T	136.8/93.8
R116	7030003440	S.RES ERJ3GEYJ 102 V (1 kΩ)	T	137.8/92.5
R117	7030003440	S.RES ERJ3GEYJ 102 V (1 kΩ)	T	136.8/91
R118	7030003440	S.RES ERJ3GEYJ 102 V (1 kΩ)	T	137.6/89.6
R119	7030003440	S.RES ERJ3GEYJ 102 V (1 kΩ)	T	137.6/88.2
R120	7030003440	S.RES ERJ3GEYJ 102 V (1 kΩ)	T	138.5/86.8
R121	7030003440	S.RES ERJ3GEYJ 102 V (1 kΩ)	T	138.5/85.4
R122	7030003360	S.RES ERJ3GEYJ 221 V (220 Ω)	T	144.6/16.6
R123	7030003360	S.RES ERJ3GEYJ 221 V (220 Ω)	T	148.8/16.6
R124	7030003360	S.RES ERJ3GEYJ 221 V (220 Ω)	T	146/16.6
R125	7030003360	S.RES ERJ3GEYJ 221 V (220 Ω)	T	147.4/16.6
R126	7030003200	S.RES ERJ3GEYJ 100 V (10 Ω)	T	127.1/19.8
R127	7030003200	S.RES ERJ3GEYJ 100 V (10 Ω)	T	128.5/19.8
R128	7030003200	S.RES ERJ3GEYJ 100 V (10 Ω)	T	132.7/19.8
R129	7030003200	S.RES ERJ3GEYJ 100 V (10 Ω)	T	131.3/19.8
R130	7030003200	S.RES ERJ3GEYJ 100 V (10 Ω)	T	134.1/19.8
R131	7030003200	S.RES ERJ3GEYJ 100 V (10 Ω)	T	129.9/19.8
R132	7030003200	S.RES ERJ3GEYJ 100 V (10 Ω)	T	135.5/19.8
R133	7030003200	S.RES ERJ3GEYJ 100 V (10 Ω)	T	136.9/19.8
R136	7030003560	S.RES ERJ3GEYJ 103 V (10 kΩ)	T	107.4/63
R137	7030003280	S.RES ERJ3GEYJ 470 V (47 Ω)	T	110.3/64.2
R138	7030003440	S.RES ERJ3GEYJ 102 V (1 kΩ)	T	116.4/68
R139	7030003560	S.RES ERJ3GEYJ 103 V (10 kΩ)	T	106.3/74.6
R140	7030003280	S.RES ERJ3GEYJ 470 V (47 Ω)	T	114.5/73.4
R141	7030003440	S.RES ERJ3GEYJ 102 V (1 kΩ)	T	116.4/71.8
R142	7030003280	S.RES ERJ3GEYJ 470 V (47 Ω)	T	120.9/62.6
R143	7030003440	S.RES ERJ3GEYJ 102 V (1 kΩ)	T	126.6/65.9

S.=Surface mount

[CTRL-A UNIT]

REF NO.	ORDER NO.	DESCRIPTION	M.	H/V LOCATION
R144	7030003280	S.RES ERJ3GEYJ 470 V (47 Ω)	T	126.6/71
R145	7030003440	S.RES ERJ3GEYJ 102 V (1 kΩ)	T	133/62.8
R146	7030003280	S.RES ERJ3GEYJ 470 V (47 Ω)	T	123.7/62.6
R147	7030003440	S.RES ERJ3GEYJ 102 V (1 kΩ)	T	124/61.3
R148	7030003640	S.RES ERJ3GEYJ 473 V (47 kΩ)	T	143.3/16.6
R149	7030003680	S.RES ERJ3GEYJ 104 V (100 kΩ)	T	166.9/66.1
R150	7030003390	S.RES ERJ3GEYJ 391 V (390 Ω)	T	46.4/92
R151	7030003430	S.RES ERJ3GEYJ 821 V (820 Ω)	T	44.5/91.2
R152	7030003520	S.RES ERJ3GEYJ 472 V (4.7 kΩ)	T	48.9/91.7
R153	7030003520	S.RES ERJ3GEYJ 472 V (4.7 kΩ)	T	45.1/93.3
R154	7030003480	S.RES ERJ3GEYJ 222 V (2.2 kΩ)	T	41/93.1
R155	7030003390	S.RES ERJ3GEYJ 391 V (390 Ω)	T	41.8/91.2
R156	7010006940	RES PSD1/4 1 K Ω		
R211	7030003380	S.RES ERJ3GEYJ 331 V (330 Ω)	T	187.4/70.2
R212	7030003380	S.RES ERJ3GEYJ 331 V (330 Ω)	T	186.1/70.2
R213	7030003380	S.RES ERJ3GEYJ 331 V (330 Ω)	T	183.4/69.9
R214	7030003380	S.RES ERJ3GEYJ 331 V (330 Ω)	T	182.1/69.9
R215	7030003380	S.RES ERJ3GEYJ 331 V (330 Ω)	T	179.6/81.7
R216	7030003380	S.RES ERJ3GEYJ 331 V (330 Ω)	T	178.3/81.7
R217	7030003380	S.RES ERJ3GEYJ 331 V (330 Ω)	T	183.8/81.3
R218	7030003380	S.RES ERJ3GEYJ 331 V (330 Ω)	T	182.5/81.7
R219	7030003440	S.RES ERJ3GEYJ 102 V (1 kΩ)	T	111.5/29.6
C1	4010005530	CER HM60SJ SL 020C 500V		
C2	4030007110	S.CER C1608 CH 1H 680J-T	T	100/49.6
C3	4610001260	S.TRI ECR-JA020 E12W	T	102.2/54.9
C4	4010005530	CER HM60SJ SL 020C 500V		
C5	4030011540	S.CER C1608 CH 1H 750J-T	T	99.6/59.9
C6	4030006860	S.CER C1608 JB 1H 102K-T	T	103.6/50.4
C7	4030006860	S.CER C1608 JB 1H 102K-T	T	105.3/55.8
C8	4030006880	S.CER C1608 JB 1H 472K-T	T	116.7/52.1
C9	4030006880	S.CER C1608 JB 1H 472K-T	T	116.2/58.4
C10	4030006880	S.CER C1608 JB 1H 472K-T	T	120.4/48.1
C11	4030006880	S.CER C1608 JB 1H 472K-T	T	120.4/43.3
C12	4010005540	CER HM60SJ SL 030C 500V		
C13	4030007070	S.CER C1608 CH 1H 330J-T	T	96.5/66.4
C14	4030007070	S.CER C1608 CH 1H 330J-T	T	97.8/66.4
C15	4030007070	S.CER C1608 CH 1H 330J-T	T	95.1/71.9
C16	4030006880	S.CER C1608 JB 1H 472K-T	T	98.2/63
C17	4030007120	S.CER C1608 CH 1H 820J-T	T	97.1/71.4
C20	4030006880	S.CER C1608 JB 1H 472K-T	T	100.3/74.8
C21	4030006880	S.CER C1608 JB 1H 472K-T	T	124.8/75.3
C22	4550003120	S.TAN TEESVD2 1A 476M-12L	T	127.6/58.1
C23	4030006880	S.CER C1608 JB 1H 472K-T	T	130.2/62.8
C24	4030007170	S.CER C1608 CH 1H 221J-T	T	130.8/81.2
C25	4030007170	S.CER C1608 CH 1H 221J-T	T	126.1/75.3
C26	4030006880	S.CER C1608 JB 1H 472K-T	T	125.6/83.4
C27	4030006880	S.CER C1608 JB 1H 472K-T	T	124.2/83.2
C30	4030007170	S.CER C1608 CH 1H 221J-T	T	121.3/83.2
C31	4030011340	S.CER C1608 CH 1H 471J-T	T	124.8/86.3
C32	4010005520	CER HM60SJ SL 010C 500V		
C33	4030016550	S.CER CM105 CH 151G 50AT	T	96.7/75.1
C35	4030006880	S.CER C1608 JB 1H 472K-T	T	99.8/77.1
C36	4030006860	S.CER C1608 JB 1H 102K-T	T	100.8/81.3
C37	4030006880	S.CER C1608 JB 1H 472K-T	T	100.8/84.1
C38	4030006880	S.CER C1608 JB 1H 472K-T	T	106/83.5
C39	4030006880	S.CER C1608 JB 1H 472K-T	T	110.4/83.5
C40	4030006880	S.CER C1608 JB 1H 472K-T	T	118.3/84.5
C43	4030007170	S.CER C1608 CH 1H 221J-T	T	110.9/85.7
C44	4030011340	S.CER C1608 CH 1H 471J-T	T	113.9/87.2
C45	4030011600	S.CER C1608 JB 1E 104K-T	T	143.4/70.6
C46	4030011600	S.CER C1608 JB 1E 104K-T	T	141/68.6
C47	4030009990	S.CER C1608 CH 1H 200J-T	T	163.7/69.4
C48	4030009990	S.CER C1608 CH 1H 200J-T	T	168/69.9
C49	4030006880	S.CER C1608 JB 1H 472K-T	T	158.8/48
C51	4030006860	S.CER C1608 JB 1H 102K-T	T	163.7/65.4
C52	4030006880	S.CER C1608 JB 1H 472K-T	T	157.4/58.9
C53	4030006880	S.CER C1608 JB 1H 472K-T	T	165/67
C54	4030006880	S.CER C1608 JB 1H 472K-T	T	162.9/63.5
C55	4030006860	S.CER C1608 JB 1H 102K-T	T	33.7/26.4
C56	4030006880	S.CER C1608 JB 1H 472K-T	T	52/24.2
C57	4030006880	S.CER C1608 JB 1H 472K-T	T	51.4/22
C58	4030006880	S.CER C1608 JB 1H 472K-T	T	67.8/72
C59	4030006880	S.CER C1608 JB 1H 472K-T	T	44.6/63
C60	4030006880	S.CER C1608 JB 1H 472K-T	T	44.3/49.2
C62	4030006880	S.CER C1608 JB 1H 472K-T	T	13.9/17.7
C63	4030007090	S.CER C1608 CH 1H 470J-T	T	33.4/74.2
C64	4030007030	S.CER C1608 CH 1H 150J-T	T	33.4/69.5
C65	4030007120	S.CER C1608 CH 1H 820J-T	T	27/74.3
C66	4030007070	S.CER C1608 CH 1H 330J-T	T	20.4/74.2
C69	4510004630	S.ELE ECEV1CA100SR	T	119.8/51.6
C70	4510004630	S.ELE ECEV1CA100SR	T	120.6/58.4
C71	4030006880	S.CER C1608 JB 1H 472K-T	T	151.8/43.5
C72	4510006260	S.ELE ECEV1AA471UP	T	143/46.2
C73	4030006880	S.CER C1608 JB 1H 472K-T	T	143.5/92.2
C74	4030006880	S.CER C1608 JB 1H 472K-T	T	143.5/90.8
C75	4030006880	S.CER C1608 JB 1H 472K-T	T	143.5/89.4
C76	4030006880	S.CER C1608 JB 1H 472K-T	T	131.4/95.2
C77	4030006880	S.CER C1608 JB 1H 472K-T	T	143.5/88
C78	4030006880	S.CER C1608 JB 1H 472K-T	T	143.5/86.6
C79	4030006880	S.CER C1608 JB 1H 472K-T	T	143.5/85.2
C80	4030006880	S.CER C1608 JB 1H 472K-T	T	131.4/93.8

M.=Mounted side (T: Mounted on the Top side, B: Mounted on the Bottom side)

[CTRL-A UNIT]

REF NO.	ORDER NO.	DESCRIPTION	M.	H/V LOCATION
C81	4030006880	S.CER C1608 JB 1H 472K-T	T	131.4/92.4
C82	4030006880	S.CER C1608 JB 1H 472K-T	T	131.4/91
C83	4030006880	S.CER C1608 JB 1H 472K-T	T	131.4/89.6
C84	4030006880	S.CER C1608 JB 1H 472K-T	T	131.4/88.2
C85	4030006880	S.CER C1608 JB 1H 472K-T	T	131.4/86.8
C86	4030006880	S.CER C1608 JB 1H 472K-T	T	131.4/85.4
C87	4030006880	S.CER C1608 JB 1H 472K-T	T	147/35.6
C88	4510004630	S.ELE ECEV1CA100SR	T	147/38.8
C89	4030006880	S.CER C1608 JB 1H 472K-T	T	134/35.6
C90	4510004630	S.ELE ECEV1CA100SR	T	134/38.8
C91	4030006880	S.CER C1608 JB 1H 472K-T	T	127.1/15.8
C92	4030006880	S.CER C1608 JB 1H 472K-T	T	128.5/15.8
C93	4030006880	S.CER C1608 JB 1H 472K-T	T	132.7/15.8
C94	4030006880	S.CER C1608 JB 1H 472K-T	T	131.3/15.8
C95	4030006880	S.CER C1608 JB 1H 472K-T	T	134.1/15.8
C96	4030006880	S.CER C1608 JB 1H 472K-T	T	129.9/15.8
C97	4030006880	S.CER C1608 JB 1H 472K-T	T	135.5/15.8
C98	4510006220	S.ELE ECEV1CA101UP	T	161.9/35.2
C100	4030011570	S.CER CM105 CH 101G 50AT	T	97.3/80.7
C101	4030006880	S.CER C1608 JB 1H 472K-T	T	110.2/69.3
C102	4510004630	S.ELE ECEV1CA100SR	T	113.3/69.9
C105	4030011540	S.CER C1608 CH 1H 750J-T	T	24.2/68.7
C107	4010005580	CER HM60SJ SL 070D 500V		
C108	4010005560	CER HM60SJ SL 050C 500V		
C109	4030011600	S.CER C1608 JB 1E 104K-T	T	50.1/91.7
C209	4030006900	S.CER C1608 JB 1H 103K-T	T	145/62.2
C210	4030006900	S.CER C1608 JB 1H 103K-T	T	142.8/57.4
C211	4510004440	S.ELE ECEV1HA010SR	T	186.7/43.1
C212	4510004440	S.ELE ECEV1HA010SR	T	186.7/38.3
C213	4510004440	S.ELE ECEV1HA010SR	T	186.7/33.5
C214	4510004440	S.ELE ECEV1HA010SR	T	186.7/28.7
C215	4510004440	S.ELE ECEV1HA010SR	T	187.5/64.7
C216	4510004440	S.ELE ECEV1HA010SR	T	186.7/58.8
C217	4510004440	S.ELE ECEV1HA010SR	T	186.7/54
C218	4510004440	S.ELE ECEV1HA010SR	T	186.7/49.2
C220	4030006880	S.CER C1608 JB 1H 472K-T	T	136.9/15.8
C228	4030005040	S.CER C2012 CH 1H 271J-T	T	90.8/56.9
C229	4030006880	S.CER C1608 JB 1H 472K-T	T	102.9/87.6
C301	4030007060	S.CER C1608 CH 1H 270J-T	T	30.6/90.8
C302	4610002210	TRI TZ03Z500F169B00		
C303	4610002210	TRI TZ03Z500F169B00		
C305	4030011600	S.CER C1608 JB 1E 104K-T	T	115/21.7
C306	4510004630	S.ELE ECEV1CA100SR	T	118.1/22.1
RL1	6330001450	RLY FXE-12G		
RL2	6330001450	RLY FXE-12G		
RL3	6330000800	RLY G5A-237P DC12V		
RL4	6330000470	RLY NR-HD (12V) AE5343		
J3	6510017150	CNR TMP-S01X-C1		
J4	6510017150	CNR TMP-S01X-C1		
J7	6510019990	S.CNR 52808-2291	T	157.2/8.4
J8	6510019990	S.CNR 52808-2291	T	111.6/92.6
J10	6510003410	CNR B05B-EH-S		
J11	6510003410	CNR B05B-EH-S		
J13	6510019970	S.CNR 52808-1091	T	132.3/8.4
J14	6910001040	CNR IPS-1136		
W1	7120000490	JMP ERD25T0		
W2	7120000490	JMP ERD25T0		
W3	7120000490	JMP ERD25T0		
EP1	0910058511	PCB B 6212A		

[FILER-A UNIT]

REF NO.	ORDER NO.	DESCRIPTION	M.	H/V LOCATION
L1	6140002570	COL LR-294 (T50-2)	T	44.9/43.3
L2	6140002580	COL LR-295 (T50-2)	T	46.1/64.3
L3	6140001240	COL LR-149 (T68-2)	T	65.9/32.3
L4	6140001130	COL LR-138 (T68-2)	T	69.3/64.7
L5	6140001800	COL LR-216 (T50-2)	T	112.4/36.7
L6	6140001800	COL LR-216 (T50-2)	T	102.5/49.8
L7	6140001800	COL LR-216 (T50-2)	T	112.2/68.8
L8	6140002270	COL LR-240 (T68-6)	T	142.5/27.4
L9	6110002920	COL LA-481	T	97.6/23.3
L10	6110002910	COL LA-480	T	90.5/56.3
L13	6200003260	S.COL NL 322522T-101J	T	39.6/21.3
L15	6200003260	S.COL NL 322522T-101J	T	55.8/9.4
L17	6200003260	S.COL NL 322522T-101J	T	135.2/7.1
L19	6200003260	S.COL NL 322522T-101J	T	104/11.9
L21	6200001830	S.COL NL 322522T-100J	T	87/9.4
L23	6200001830	S.COL NL 322522T-100J	T	118.2/10.4
L24	6140003450	COL LR-387	T	130.5/26

S.=Surface mount

[FILER-A UNIT]

REF NO.	ORDER NO.	DESCRIPTION	M.	H/V LOCATION
L25	6140003460	COL LR-388	T	128.1/46.6
L26	6140003460	COL LR-388	T	122.8/58.7
L28	6140002280	COL LR-241 (T68-6)	T	144/46.7
L29	6110003540	COL LA-548 (LA-215A)	T	164.5/30.5
L30	6110003570	COL LA-550	T	156.9/45.8
L31	6110003550	COL LA-547 (LA-214A)	T	161.1/59
L32	6200001830	S.COL NL 322522T-100J	T	150.6/6.5
L41	6200001830	S.COL NL 322522T-100J	T	73.9/11.6
L45	6140003560	COL LR-394	T	80.4/42.8
L46	6140001820	COL LR-218 (T50-10)	T	80.4/58.4
L501	6140003440	COL LR-386	T	14/52.5
L502	6140003440	COL LR-386	T	14/21
R1	7030003860	S.RES ERJ3GE JPW V	T	147.1/78.4
R2	7030003860	S.RES ERJ3GE JPW V	T	152.7/69.5
R3	7030003860	S.RES ERJ3GE JPW V	T	132.6/65.4
R4	7030003860	S.RES ERJ3GE JPW V	T	119.3/73
R5	7030003860	S.RES ERJ3GE JPW V	T	102.2/73.5
R6	7030003860	S.RES ERJ3GE JPW V	T	69.1/85.2
R7	7030003860	S.RES ERJ3GE JPW V	T	55.1/86
R8	7030003860	S.RES ERJ3GE JPW V	T	87.8/82.8
C2	4010008260	CER HM74TJ SL 151J 500V	T	57/38.4
C3	4010008200	CER HM11TJ SL 331J 500V	T	54.5/36.3
C5	4030012480	S.CER GRM31M2C2H121JV01L	T	55.5/60.6
C7	4010005360	CER HM11SJ SL 301J 500V	T	64.2/20.8
C8	4010005360	CER HM11SJ SL 301J 500V	T	67.1/23.8
C10	4010005360	CER HM11SJ SL 301J 500V	T	69.5/33.7
C12	4030011730	S.CER GRM31M2C2H101JV01L	T	59.3/62.1
C14	4010005360	CER HM11SJ SL 301J 500V	T	67.3/67.3
C15	4010008300	CER HM11TJ SL 391J 500V	T	67.3/70.1
C16	4010005880	CER HM95SJ SL 271J 500V	T	110.9/27
C17	4010005870	CER HM95SJ SL 221J 500V	T	110.9/24.7
C18	4030011730	S.CER GRM31M2C2H101JV01L	T	101/38.8
C19	4030011240	S.CER GRM31M2C2H470JV01L	T	103/38.8
C20	4010008300	CER HM11TJ SL 391J 500V	T	112.9/39
C21	4010005360	CER HM11SJ SL 301J 500V	T	110.6/41
C22	4030012480	S.CER GRM31M2C2H121JV01L	T	106.5/53
C23	4030011230	S.CER GRM31M2C2H390JV01L	T	106.4/51
C24	4010008300	CER HM11TJ SL 391J 500V	T	105.1/55.5
C25	4010008300	CER HM11TJ SL 391J 500V	T	106.6/58.2
C26	4030011230	S.CER GRM31M2C2H390JV01L	T	109.3/70.7
C27	4010005880	CER HM95SJ SL 271J 500V	T	114.2/70.5
C28	4030011730	S.CER GRM31M2C2H101JV01L	T	146.4/25.4
C30	4030011170	S.CER GRM31M2C2H180JV01L	T	138.9/37
C31	4030011730	S.CER GRM31M2C2H101JV01L	T	146.9/38.3
C32	4030012480	S.CER GRM31M2C2H121JV01L	T	96/21.3
C33	4030011170	S.CER GRM31M2C2H180JV01L	T	94/34.9
C34	4030012480	S.CER GRM31M2C2H121JV01L	T	91.7/40
C35	4030011230	S.CER GRM31M2C2H390JV01L	T	96.5/54.1
C36	4030011730	S.CER GRM31M2C2H101JV01L	T	95/69.4
C37	4030011190	S.CER GRM31M2C2H270JV01L	T	127.1/26.8
C38	4030012480	S.CER GRM31M2C2H121JV01L	T	127/37.3
C39	4030011190	S.CER GRM31M2C2H270JV01L	T	138.2/43.6
C40	4030011550	S.CER GRM31M2C2H680JV01L	T	121.2/51.1
C41	4030011120	S.CER GRM31M2C2H100JV01L	T	132.9/55.8
C42	4030006880	S.CER C1608 JB 1H 472K-T	T	42/16.5
C43	4030006880	S.CER C1608 JB 1H 472K-T	T	55.1/82.9
C44	4030006880	S.CER C1608 JB 1H 472K-T	T	58.3/11.6
C45	4030006880	S.CER C1608 JB 1H 472K-T	T	69.7/82.9
C46	4030006880	S.CER C1608 JB 1H 472K-T	T	138.3/10
C47	4030006880	S.CER C1608 JB 1H 472K-T	T	145.6/69
C48	4030006880	S.CER C1608 JB 1H 472K-T	T	103.7/18.1
C49	4030006880	S.CER C1608 JB 1H 472K-T	T	116.9/80.5
C50	4030006880	S.CER C1608 JB 1H 472K-T	T	92.1/10.2
C51	4030006880	S.CER C1608 JB 1H 472K-T	T	102.1/79.1
C52	4030006880	S.CER C1608 JB 1H 472K-T	T	122.9/9.7
C53	4030006880	S.CER C1608 JB 1H 472K-T	T	131.9/72.3
C62	4030011730	S.CER GRM31M2C2H101JV01L	T	147.5/56.1
C63	4030011240	S.CER GRM31M2C2H470JV01L	T	140/56.1
C65	4030011730	S.CER GRM31M2C2H101JV01L	T	147.1/58.4
C66	4010005360	CER HM11SJ SL 301J 500V	T	62.2/52.7
C67	4010005360	CER HM11SJ SL 301J 500V	T	62.5/48.6
C68	4010005360	CER HM11SJ SL 301J 500V	T	62.6/44.6
C69	4010005360	CER HM11SJ SL 301J 500V	T	62.7/41.4
C72	4010008280	CER HM95TJ SL 221J 500V	T	46.1/55.4
C73	4010005390	CER HM15SJ SL 621J 500V	T	53.6/53.3
C74	4010005390	CER HM15SJ SL 621J 500V	T	49/49.9
C75	4010005390	CER HM15SJ SL 621J 500V	T	55.2/47.6
C77	4030011210	S.CER GRM31M2C2H330JV01L	T	164.1/27.1
C78	4030011240	S.CER GRM31M2C2H470JV01L	T	155.6/42.7
C79	4030011240	S.CER GRM31M2C2H470JV01L	T	152.7/45.5
C80	4030011240	S.CER GRM31M2C2H470JV01L	T	155.2/59.1
C81	4030011240	S.CER GRM31M2C2H470JV01L	T	155.2/61.9
C82	4030011230	S.CER GRM31M2C2H390JV01L	T	155.2/65.9
C83	4030011080	S.CER GRM31M2C2H680JV01L	T	167.5/35.6
C85	4030011160	S.CER GRM31M2C2H150JV01L	T	168.6/45.6
C86	4030011180	S.CER GRM31M2C2H220JV01L	T	158.9/62.5
C87	4030006880	S.CER C1608 JB 1H 472K-T	T	156.8/26.7
C88	4030006880	S.CER C1608 JB 1H 472K-T	T	155.6/83.6
C97	4010005390	CER HM15SJ SL 621J 500V	T	49.2/33.3
C98	4010005390	CER HM15SJ SL 621J 500V	T	51.6/30.1
C99	4010005390	CER HM15SJ SL 621J 500V	T	49.2/69.8
C100	4010005390	CER HM15SJ SL 621J 500V	T	53.1/66.9
C102	4030011730	S.CER GRM31M2C2H101JV01L	T	146.9/40.9

M.=Mounted side (T: Mounted on the Top side, B: Mounted on the Bottom side)

[FILER-A UNIT]

REF NO.	ORDER NO.	DESCRIPTION	M.	H/V LOCATION
C103	4030012480	S.CER GRM31M2C2H121JV01L	T	146.9/43.4
C104	4030012480	S.CER GRM31M2C2H121JV01L	T	91.7/37.9
C136	4030006880	S.CER C1608 JB 1H 472K-T	T	74.8/15
C137	4030006880	S.CER C1608 JB 1H 472K-T	T	88.6/79.9
C141	4010008290	CER HM95TJ SL 271J 500V	T	74.8/26
C142	4030011230	S.CER GRM31M2C2H390JV01L	T	78.8/33.4
C143	4010008280	CER HM95TJ SL 221J 500V	T	81.2/46.1
C144	4010008280	CER HM95TJ SL 221J 500V	T	81.2/48.8
C145	4030006880	S.CER GRM31M2C2H820JV01L	T	83.8/60.7
C146	4030014460	S.CER GRM31M2C2H820JV01L	T	80.2/68.9
C151	4010008200	CER HM11TJ SL 331J 500V	T	46/27
C152	4010005390	CER HM15SJ SL 621J 500V	T	51.6/24.4
C153	4010008200	CER HM11TJ SL 331J 500V	T	44.9/44.9
C156	4030011550	S.CER GRM31M2C2H680JV01L	T	121.6/48.1
C157	4030011210	S.CER GRM31M2C2H330JV01L	T	124.6/52.7
C501	4030006480	S.CER GRM319B11H104KA01D	T	24.5/85.7
C502	4030006480	S.CER GRM319B11H104KA01D	T	15.5/85.7
C503	4030004740	S.CER C2012 JB 1H 472K-T	T	27/86
C504	4030004740	S.CER C2012 JB 1H 472K-T	T	13/86
C507	4030006480	S.CER GRM319B11H104KA01D	T	20/84
C508	4030004740	S.CER C2012 JB 1H 472K-T	T	20/80.5
C513	4030006480	S.CER GRM319B11H104KA01D	T	30/47
C514	4030006480	S.CER GRM319B11H104KA01D	T	10/47
C515	4030004740	S.CER C2012 JB 1H 472K-T	T	30/44.5
C516	4030004740	S.CER C2012 JB 1H 472K-T	T	10/44.5
C517	4510004330	ELE 35 MV 10 SWB	T	21/47
C521	4030004740	S.CER C2012 JB 1H 472K-T	T	33.4/21.5
C522	4030004740	S.CER C2012 JB 1H 472K-T	T	6.6/21.5
C523	4030006480	S.CER GRM319B11H104KA01D	T	33.1/19
C524	4030006480	S.CER GRM319B11H104KA01D	T	6.8/19
C527	4030006480	S.CER GRM319B11H104KA01D	T	20/8.3
C528	4510004330	ELE 35 MV 10 SWB	T	21.1/14.3
RL1	6330001510	RLY TB1-160	T	49/21.8
RL2	6330001510	RLY TB1-160	T	49.6/75.3
RL3	6330001510	RLY TB1-160	T	64.4/18.6
RL4	6330001510	RLY TB1-160	T	63.6/72.3
RL5	6330001510	RLY TB1-160	T	143.8/18.9
RL6	6330001510	RLY TB1-160	T	140.1/61.6
RL7	6330001510	RLY TB1-160	T	110.7/22
RL8	6330001510	RLY TB1-160	T	110.7/72.8
RL9	6330001510	RLY TB1-160	T	97.6/19.1
RL10	6330001510	RLY TB1-160	T	96.6/71.5
RL11	6330001510	RLY TB1-160	T	128.4/18.6
RL12	6330001510	RLY TB1-160	T	126.4/64.7
RL13	6330001330	RLY AG 201344	T	168/24.5
RL14	6330001330	RLY AG 201344	T	167.5/81.5
RL15	6330001510	RLY TB1-160	T	80.3/23.9
RL16	6330001510	RLY TB1-160	T	82.3/71.5
J1	6510007020	CNR TMP-J01X-V6	T	159.7/12
J2	6510007020	CNR TMP-J01X-V6	T	148/83.1
J3	6510019970	S.CNR 52808-1091	T	128.5/86
W9	8900009621	CBL OPC-961A	T	
W10	8900009631	CBL OPC-962A	T	
EP1	0910058670	PCB B 6218	T	
EP501	6510018330	TER F4053A	T	32.5/79
EP502	6510018330	TER F4053A	T	7.5/79

[CHASSIS UNIT]

REF NO.	ORDER NO.	DESCRIPTION	M.	H/V LOCATION
J5	6510000370	CNR MR-DS		
J6	6510000370	CNR MR-DS		
SP1	2510000760	SP SM-77KY0208		
MF1	2710000630	FAN FBA08T12HC		
W7	8900009240	CBL OPC-909 (P=1 N=10 L=110)		
W8	8900009260	CBL OPC-911 (P=1 N=16 L=70)		
W10	8900009220	CBL OPC-907 (N:22 L:170)		
W11	8900009310	CBL OPC-916 (P=1 N=22 L=120)		
W12	8900009290	CBL OPC-914 (P=1 N=22 L=340)		
W13	8900009320	CBL OPC-918 (P=1 N=30 L=180)		
W14	8900009220	CBL OPC-907 (N:22 L:170)		
W15	8900007152	CBL OPC-699B		
W16	8900007020	CBL OPC-686 (N:22 L:120)		
EP1	6910000340	SHT P101 KD		
EP2	6910000310	EPT B312D		

S.=Surface mount

SECTION 6 MECHANICAL PARTS AND DISASSEMBLY

[FRONT PARTS]

REF. NO.	ORDER NO.	DESCRIPTION	QTY.
DS1	5080000450	Lamp SLU2LC1EX5B-TH	1
EP1	6910011090	Sensor unit RMS20-250-201-P	1
EP2	6450001230	Snap plate HLJ0999-01-480	1
EP3	6450001230	Snap plate HLJ0999-01-480	1
EP4	6910012500	Unit board TFD50W40-A	1
ME1	5510000490	Meter ME-41 (KL-293S-11)	1
MP1	8210021251	1876 front panel (D)-1	1
MP2	8010016722	1876 SUB chassis-2	1
MP3	8930041380	1876 window plate	1
MP4	8930056110	1876 power button (A)	1
MP5	8930050370	1876 4-key (A)	1
MP6	8930056090	1876 key board (B)	1
MP7	8930056100	1876 7-key (B)	1
MP8	8930050380	1876 5-key (A)	1
MP9	8930056080	1876 10-key (B)	1
MP10	8930041280	1876 2-key	1
MP11	8610010720	Knob N273	3
MP12	8610010260	Knob N252	3
MP13	8610010270	Knob N253	1
MP14	8610010650	Knob N268 assembly	1
MP19	8310063330	2178 B-name plate	1
MP20	8930041060	1876 brake plate	1
MP21	8930027470	1296 brake pad	1
MP23	8810008660	Screw PH BT M3 × 8 NI-ZU	6
MP24	8810008760	Screw PH BT M2 × 8 NI-ZU	1
MP25	8810008760	Screw PH BT M2 × 8 NI-ZU	2
MP26	8810009560	Screw PH BT M2 × 6 ZK	6
MP27	8810009560	Screw PH BT M2 × 6 ZK	6
MP29	8820000770	1296 screw	1
MP30	8810009390	Screw PH BT M3 × 18 NI-ZU	1
MP40	8810008760	Screw PH BT M2 × 8 NI-ZU	2
MP41	8810008760	Screw PH BT M2 × 8 NI-ZU	2
MP49	8810008200	Screw PH BT M2.6 × 6 NI-ZU	2
MP50	8810007300	Screw PH B0 M2.6 × 14 ZK	1
MP51	8610010740	Knob N273 (A)	1
MP52	8610010730	Knob N252 (A)	1
MP53	8850001250	Flat washer M2.6	1
MP54	8930051520	Sheet	1
MP60	8930057320	2178 LCD sheet	1
MP61	8930057340	Copper coated sheet (L)	1
MP62	8930057340	Copper coated sheet (L)	1
MP63	8930050280	Copper coated sheet (H)	1
MP70	8930064540	Shield sponge (AN)	1

[PHONE BOARD]

REF. NO.	ORDER NO.	DESCRIPTION	QTY.
J2	6450001980	Connector HLJ5815-01-030	1
MP1*	8930054900	2356 earth spring	1

[KEY BOARD]

REF. NO.	ORDER NO.	DESCRIPTION	QTY.
J2	6450001790	Connector HLJ7000-01-3010	1
MP1*	8930054530	2355 earth spring	1

[MIC BOARD]

REF. NO.	ORDER NO.	DESCRIPTION	QTY.
J1	6510000190	Connector FM214-8SS (P)	1
MP1*	8930024170	Earth spring (G)	1

[PBT BOARD]

REF. NO.	ORDER NO.	DESCRIPTION	QTY.
R1	7210002970	Variable resistor RV-314	1
S1	2250000410	Encoder TP90D96E20-30F-2178-1	1

[RIT BOARD]

REF. NO.	ORDER NO.	DESCRIPTION	QTY.
S1	2250000340	Encoder EVQ-VCJF0324B	1

Note *: Refer to SECTION 8

[DISPLAY BOARD]

REF. NO.	ORDER NO.	DESCRIPTION	QTY.
R701	7210002890	Variable resistor RK161221005J/RV-308	1
R702	7210002890	Variable resistor RK161221005J/RV-308	1
MP1	8510012630	2178 shield case	1
MP3	8510010760	1876 DDS case	1
MP4	8510010770	1876 DDS cover	1
MP5	8510001081	Shield case (A)-1	1
MP6	8510001101	Shield case (A) cover (A)-1	1
MP7	8210013980	1876 reflector	1
MP8*	8930054530	2355 earth spring	1

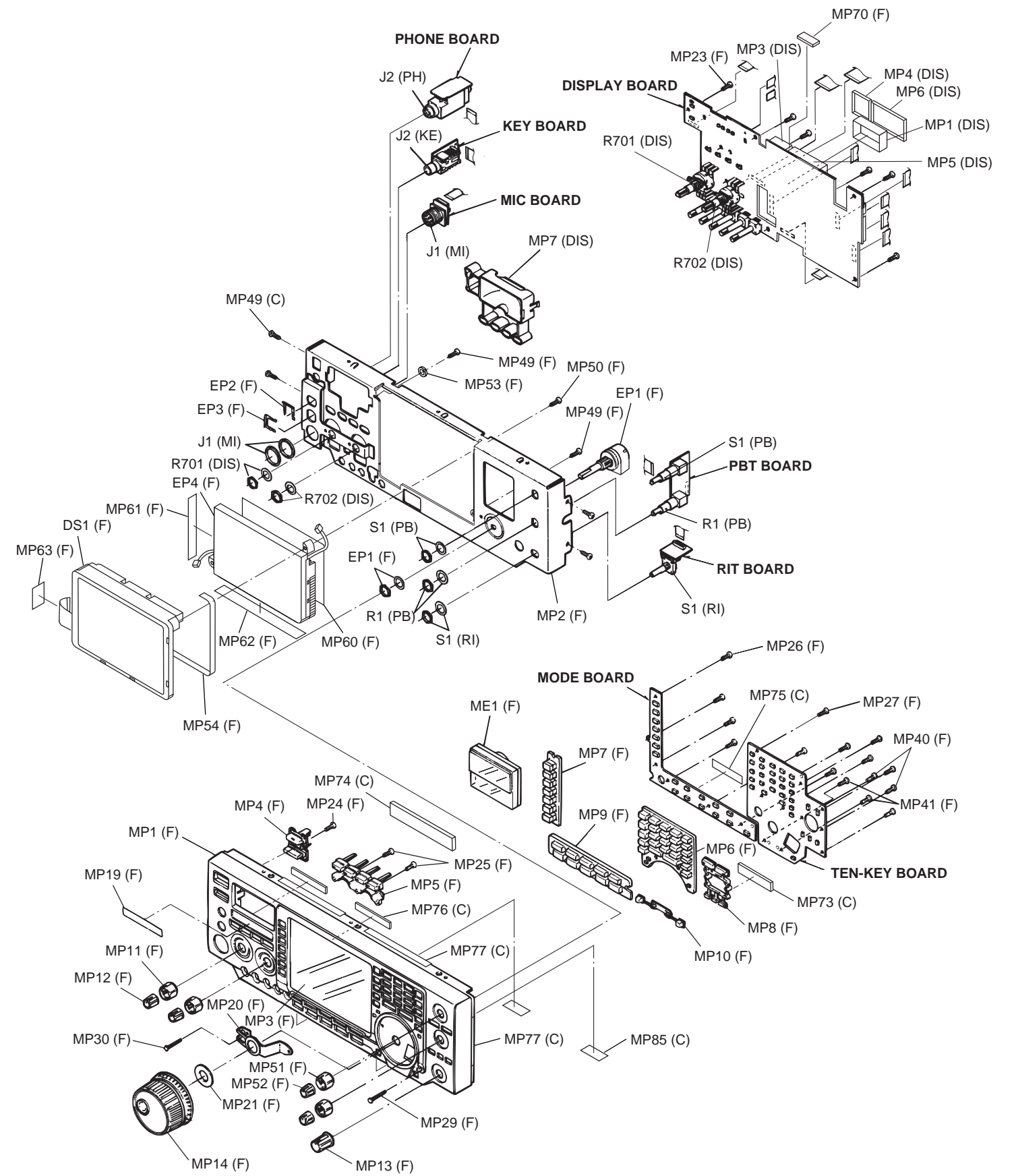
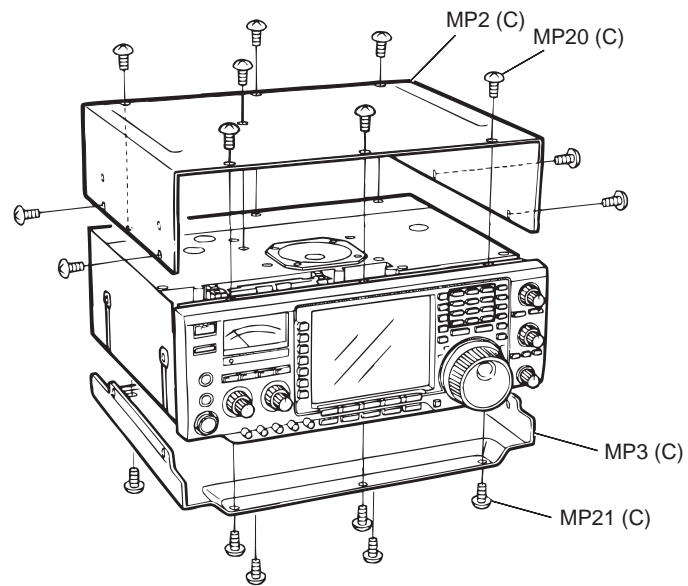
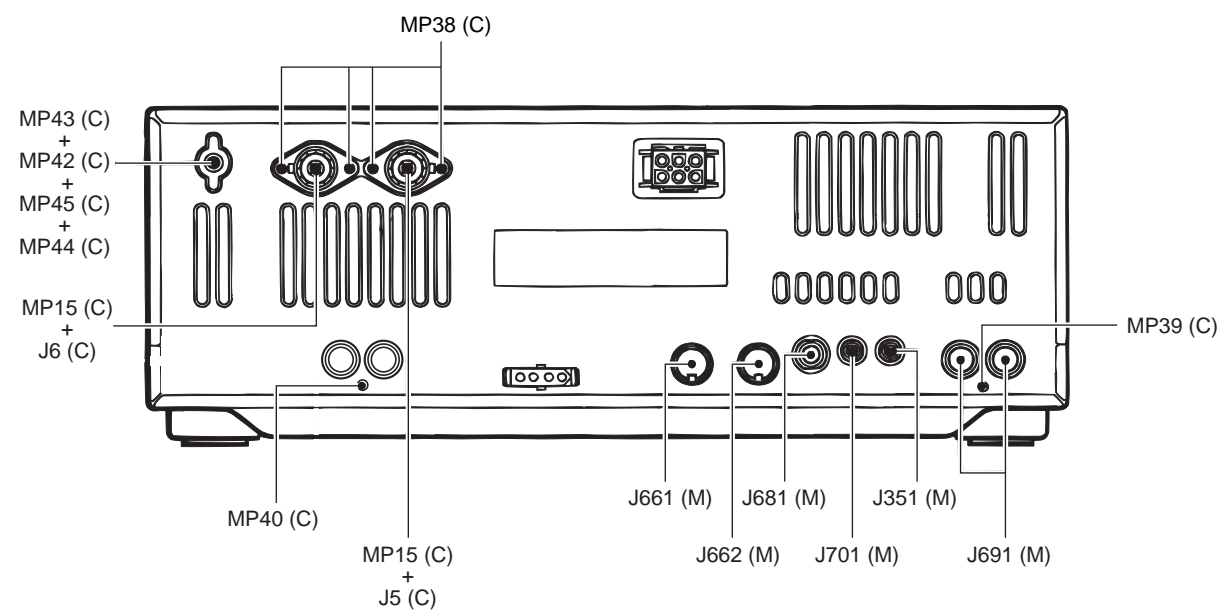
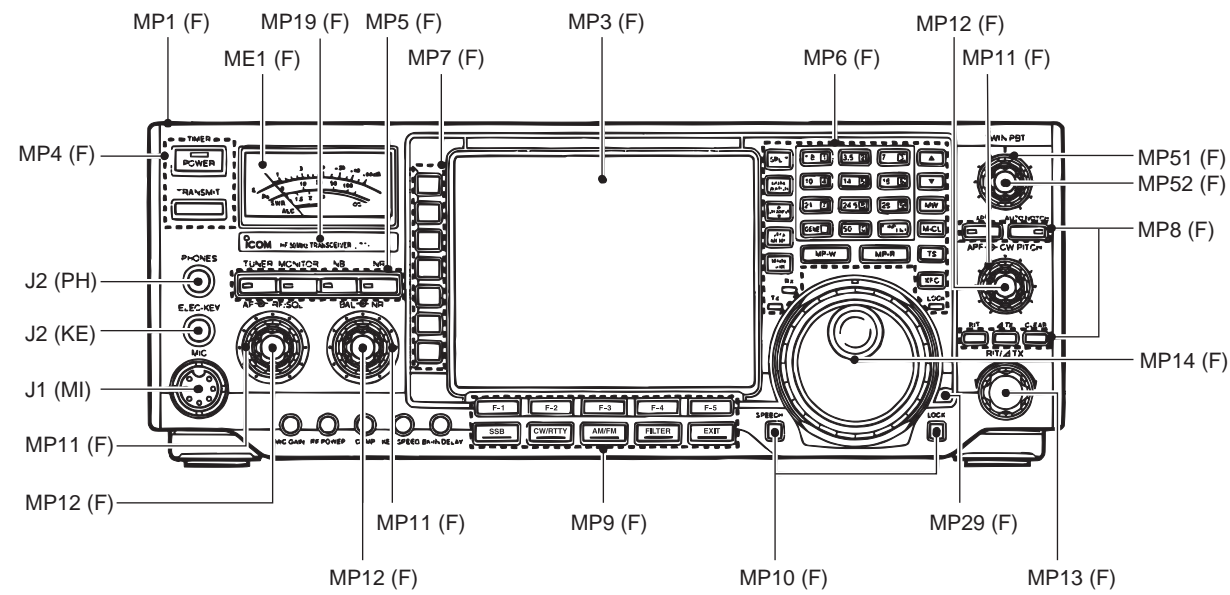

Unit abbreviations (F) : FRONT UNIT (C) : CHASSIS PARTS (PB) : PBT BOARD (RI) : RIT BOARD (DIS) : DISPLAY BOARD (MI) : MIC BOARD (KE) : KEY BOARD (PH) : PHONE BOARD

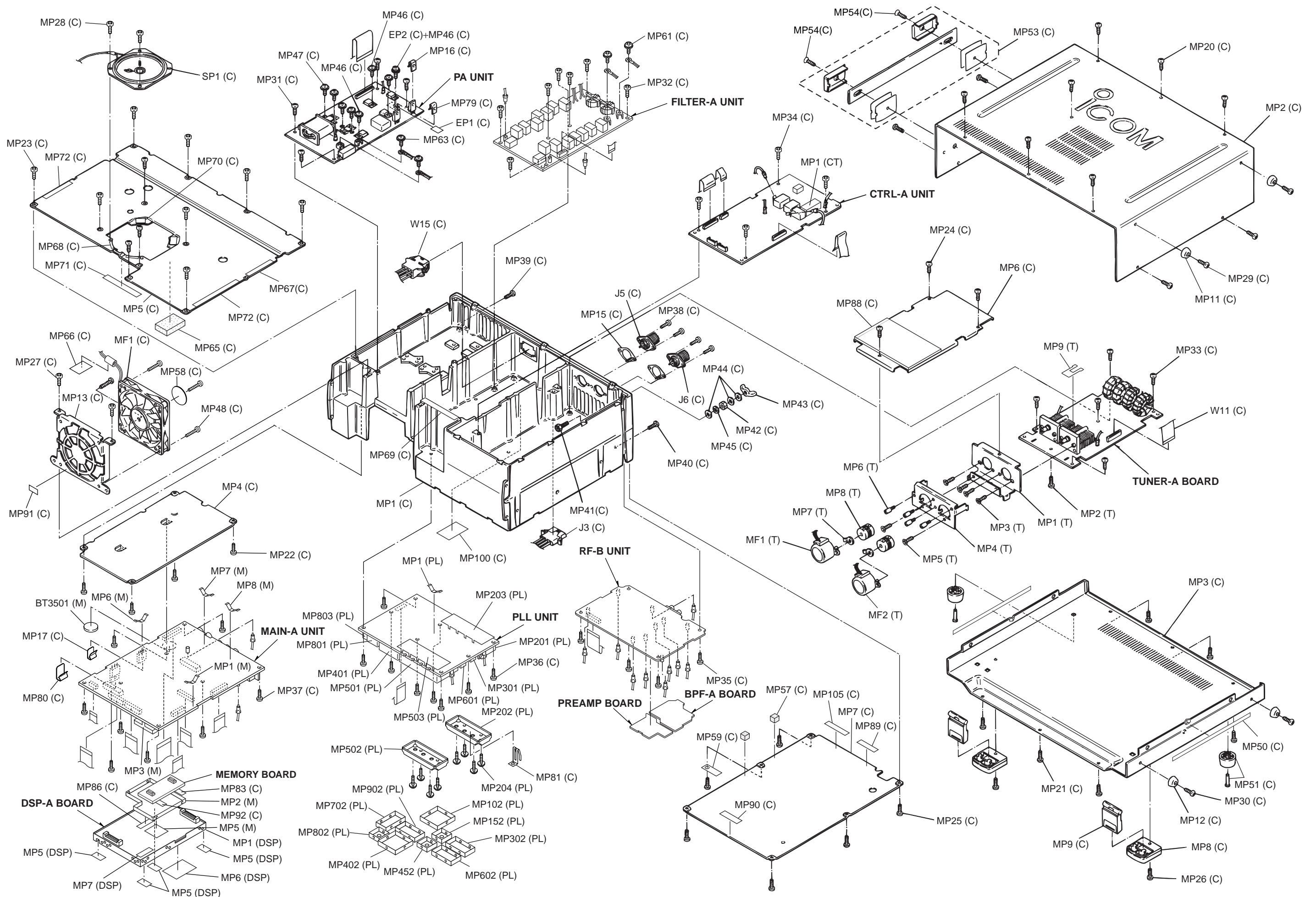

Unit abbreviations (C) : CHASSIS PARTS (M) : MAIN-A UNIT (RF) : RF-B UNIT (T) : TUNER-A BOARD
 (PL) : PLL UNIT (DSP) : DSP-A BOARD (CT) : CTRL-A UNIT

[CHASSIS PARTS]

REF. NO.	ORDER NO.	DESCRIPTION	QTY.
J3	6510001920	Connector 1490R	1
J5	6510000370	Connector MR-DS	1
J6	6510000370	Connector MR-DS	1
W15	8900007152	Cable OPC-699B	1
EP1	6910000340	Sheet P101 KD	1
EP2	6910000310	Insulation plate B312D	1
MF1	2710000630	Fan FBA08T12HC	1
SP1	2510000760	Speaker SM-77KY0208	1
MP1	8410002322	1876 heatsink (A)-2	1
MP2	8110005932	1876 T-cover-2	1
MP3	8110007101	2178 L-cover-1	1
MP4	8510012530	2178 A-plate	1
MP5	8510010730	1876 B-plate	1
MP6	8510010740	1876 C-plate	1
MP7	8510010751	1876 D-plate-1	1
MP8	8930041351	1876 MAIN stand-1	2
MP9	8930041341	1876 SUB stand-1	2
MP11	8930002910	Rubber foot (B)	2
MP12	8930002910	Rubber foot (B)	2
MP13	8930029730	1413 fan holder	1
MP15	8930037001	1691 earth plate-1	2
MP16	8930018520	TR clip (A)	1
MP17	8930035240	1546 TR-B clip	1
MP20	8810005770	Screw BiH M3 × 8 ZK	11
MP21	8810005770	Screw BiH M3 × 8 ZK	6
MP22	8810008660	Screw PH BT M3 × 8 NI-ZU	4
MP23	8810008660	Screw PH BT M3 × 8 NI-ZU	11
MP24	8810008660	Screw PH BT M3 × 8 NI-ZU	3
MP25	8810008660	Screw PH BT M3 × 8 NI-ZU	6
MP26	8810008660	Screw PH BT M3 × 8 NI-ZU	2
MP27	8810008660	Screw PH BT M3 × 8 NI-ZU	2
MP28	8810008660	Screw PH BT M3 × 8 NI-ZU	2
MP29	8810004430	Screw PH M3 × 6 ZK	2
MP30	8810004430	Screw PH M3 × 6 ZK	2
MP31	8810008660	Screw PH BT M3 × 8 NI-ZU	4
MP32	8810008660	Screw PH BT M3 × 8 NI-ZU	7
MP33	8810008660	Screw PH BT M3 × 8 NI-ZU	5
MP34	8810008660	Screw PH BT M3 × 8 NI-ZU	4
MP35	8810008660	Screw PH BT M3 × 8 NI-ZU	4
MP36	8810008660	Screw PH BT M3 × 8 NI-ZU	8
MP37	8810008660	Screw PH BT M3 × 8 NI-ZU	7
MP38	8810008660	Screw PH BT M3 × 8 NI-ZU	4
MP39	8810008660	Screw PH BT M3 × 8 NI-ZU	1
MP40	8810008660	Screw PH BT M3 × 8 NI-ZU	1
MP41	8810008160	Hex head bolt M5 ×18 NI (+)	1
MP42	8830000210	Nut M5 NI BS	1
MP43	8830000360	Wing nut M5 NI	1
MP44	8850000150	Flat washer M5 NI BS	3
MP45	8850000440	Spring washer M5 NI	1
MP46	8810003170	Setscrew A M3 × 8	4
MP47	8810003170	Setscrew A M3 × 8	4
MP48	8810000420	Screw PH M4 ×18	4
MP49	8810009310	Screw FH BT M3 × 6 NI-ZU	4
MP50	8930048120	Shield tape (A)	2
MP51	8930042690	Rubber foot (L)	2
MP53	8010001060	Carrying handle assembly	1
MP54	8810003080	Screw PH FH M4 × 12 CR BS	2
MP57	8930027900	Sponge (DD)	2
MP58	8930038820	Alumi sheet V	1
MP59	8930001170	Earth spring (A)	1
MP61	8810003160	Setscrew A M3 × 6	2
MP63	8810003160	Setscrew A M3 × 6	2
MP65	8930043281	Sponge (EW)-1	1
MP66	8930043800	Double coated tape (S)	1
MP67	8930029050	Himelton sheet AL	1

[CHASSIS PARTS]

REF. NO.	ORDER NO.	DESCRIPTION	QTY.
MP68	8930032130	Himelton sheet AQ	2
MP69	8930029050	Himelton sheet AL	1
MP70	8930008670	Sponge (AQ)	2
MP71	8930043490	Sponge (FB)	1
MP72	8930007840	Himelton sheet K	2
MP73	8930043600	Sponge (FE)	1
MP74	8930043480	Sponge (FA)	1
MP75	8930041160	Himelton sheet BO	1
MP76	8930037830	Sponge (ED)	2
MP77	8930007840	Himelton sheet K	4
MP79	8930035240	1546 TR-B clip	1
MP80	8930027940	1126 TR-B clip	1
MP81	8930017260	758 module earth spring	1
MP83	8930043090	Sponge (EV)	1
MP85	8930049130	Shield tape (D)	2
MP86	8930052101	Shield sponge (C)-1	1
MP88	8930054550	Insulation plate GL	1
MP89	8930052271	Shield sponge (D)-1	1
MP90	8930052271	Shield sponge (D)-1	1
MP91	8930050050	Sponge (GJ)	1
MP92	8930043090	Sponge (EV)	1
MP100	8930064530	Thermally sheet (AT)	1
MP104*	8930017260	758 module earth spring (for PLL unit)	1
MP105	8930064840	Shield sponge (AO)	1

[MAIN-A UNIT]

REF. NO.	ORDER NO.	DESCRIPTION	QTY.
J351	6450000140	Connector H5J0807-01-010	1
J661	6510023670	Connector TCS4480-01-4151	1
J662	6510023660	Connector TCS4470-01-4151	1
J681	6450001490	Connector HLJ7001-01-3010	1
J691	6450001130	Connector JPJ2042-01-110	1
J701	6450000140	Connector H5J0807-01-010	1
BT3501	3020000110	Lithium battery CR2032	1
MP1	8930014140	Earth spring (D)	1
MP2	8510012880	2178 A-shield cover assembly	1
MP3	8510012780	2178 A-shield case	1
MP5	8930032290	Sponge (DQ)	1
MP6	8930014140	Earth spring (D)	1
MP7	8930014140	Earth spring (D)	1
MP8	8930014140	Earth spring (D)	1
MP9*	8510000230	220 shield case	1
MP10*	8510000241	220 shield case cover -1	1
MP11*	8930004070	Earth spring (C)	1

[DSP-A BOARD]

REF. NO.	ORDER NO.	DESCRIPTION	QTY.
MP1	8510012573	2178 DSP case-3	1
MP2*	8930057311	Shield sponge (I)-1	1
MP5	8930043440	Sponge (EY)	4
MP6	8930052890	Shield tape (G)	1
MP7	8930027700	Insulation sheet (E)	1

[CTRL-A UNIT]

REF. NO.	ORDER NO.	DESCRIPTION	QTY.
MP1	8510002020	MIX shield case	1

[PLL UNIT]

REF. NO.	ORDER NO.	DESCRIPTION	QTY.
MP1	8930014140	Earth spring (D)	1
MP51*	8510000230	220 shield case	1
MP101*	8510010760	1876 DDS case	1
MP102	8510010770	1876 DDS cover	1
MP103*	8510005330	Coil case	1
MP151*	8510012550	2178 DDS case	1
MP152	8510012580	2178 DDS cover	1
MP201	8510012540	2178 VCO case	1
MP202	8510011520	2072 VCO cover	1
MP203	8510011710	2072 VCO shield plate	1
MP204	8810003960	Setscrew A M2.6 × 5	8
MP301	8510005980	724 shield case	1
MP302	8510005990	724 shield case cover	1
MP401	8510010760	1876 DDS case	1
MP402	8510010770	1876 DDS cover	1
MP403*	8510005330	Coil case	1
MP451*	8510012550	2178 DDS case	1
MP452	8510012580	2178 DDS cover	1
MP501	8510012540	2178 VCO case	1
MP502	8510011520	2072 VCO cover	1
MP503	8510011710	2072 VCO shield plate	1
MP601	8510005980	724 shield case	1
MP602	8510005990	724 shield case cover	1
MP701*	8510005980	724 shield case	1
MP702	8510005990	724 shield case cover	1
MP801	8510012550	2178 DDS case	1
MP802	8510012580	2178 DDS cover	1
MP803	8510012400	2177 D/A case	1
MP901*	8510005980	724 shield case	1
MP902	8510005990	724 shield case cover	1

[RF-B UNIT]

REF. NO.	ORDER NO.	DESCRIPTION	QTY.
MP1001*	8510016730	2178 1MIX case	1
MP1002*	8510016720	2178 1MIX cover	1
MP1201*	8510016730	2178 1MIX case	1
MP1202*	8510016720	2178 1MIX cover	1
MP1451*	8510012400	2177 D/A case	1
MP1751*	8510005150	602 shield case	1
MP1752*	8510005160	602 shield case cover	1
MP1755*	8510005150	602 shield case	1
MP1756*	8510005160	602 shield case cover	1
MP1801*	8510005150	602 shield case	1
MP1802*	8510005160	602 shield case cover	1
MP1851*	8510005150	602 shield case	1
MP1852*	8510005160	602 shield case cover	1
MP2100*	8510016550	2178 SCOPE case	1
MP2101*	8510016560	2178 SCOPE cover	1
MP2102*	8930014140	Earth spring (D)	1

[TUNER-A UNIT]

REF. NO.	ORDER NO.	DESCRIPTION	QTY.
MF1	2710000460	Motor MP28GA	1
MF2	2710000460	Motor MP28GA	1
MP1	8930041090	1876 A-angle	1
MP2	8810008660	Screw PH BT M3 × 8 NI-ZU	1
MP3	8810009060	Screw FH M3 × 6 ZK	4
MP4	8930041110	1876 B-angle	1
MP5	8810009060	Screw FH M3 × 6 ZK	2
MP6	8820000880	1528 screw	4
MP7	8930030111	1414 plate-1	2
MP8	8950003200	Universal couplings UJ6-5	2
MP9	8930051580	2178 tuner plate	1

[ACCESSORIES]



REF. NO.	ORDER NO.	DESCRIPTION	QTY.
F1	5210000090	Fuse FGB 30A	2
F2	5210000060	Fuse FGB 5A	1
W1	8900006490	Cable OPC-025 D	1
MC1	7700000540	Microphone HM-36	1

Screw abbreviations BT, B0: Self-tapping
 PH: Pan head FH: Flat head
 BiH: Binding head ZK: Black
 BS: Brass NI: Nickel
 CR: Chrome NI-ZU: Nickel-Zinc

Note *: Refer to SECTION 8.



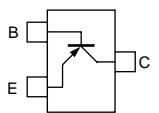
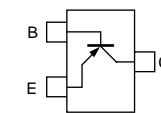
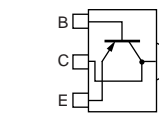
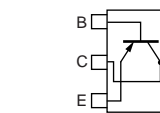
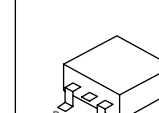
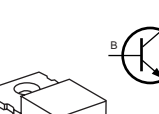

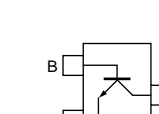
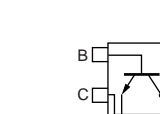
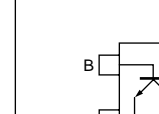
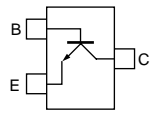
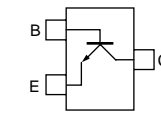
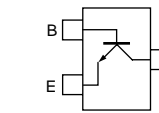
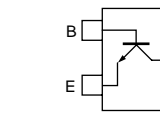
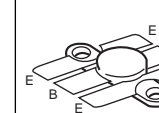
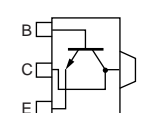
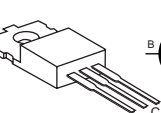
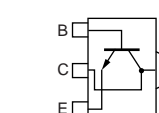
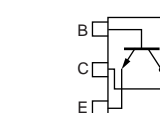
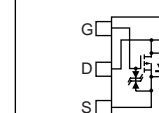
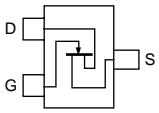
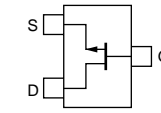
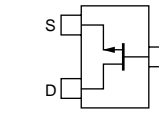
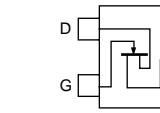
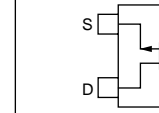
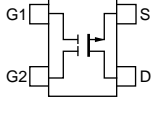
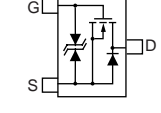
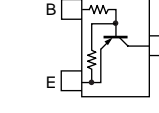
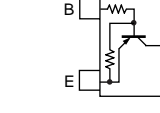
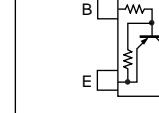
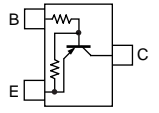
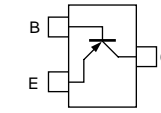
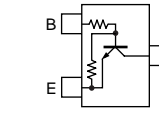
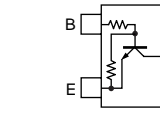
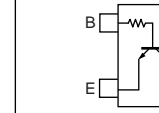
SECTION 7 SEMI-CONDUCTOR INFORMATION

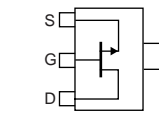
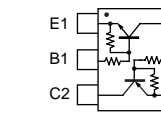
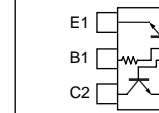
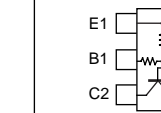
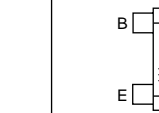
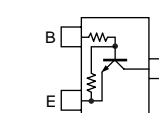
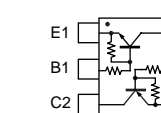
• TRANSISTORS AND FET'S

2SA1576A T106 R (Symbol: FR) 	2SA1577 T106 Q (Symbol: HQ) 	2SB1124 S TD (Symbol: BG) 	2SB1132 T100 R (Symbol: BAR) 	2SB1201 S (Symbol: B1201) 
2SC1971 (Symbol: None) 	2SC1972 (Symbol: None) 	2SC2714 O (Symbol: QO) 	2SC3647 S TD (Symbol: CC) 	2SC4081 T106 R (Symbol: BR) 
2SC4117 GR (Symbol: DG) 	2SC4213 B (Symbol: AB) 	2SC4403 3 TL (Symbol: LY3) 	2SC4405 3 TL (Symbol: OY3) 	2SC5125 
2SC5551 (Symbol: EB) 	2SD1585 K (Symbol: None) 	2SD1619 T TD (Symbol: DB) 	2SD1801 S TL (Symbol: CE) 	2SJ381 TD (Symbol: JI) 
2SK210 GR (Symbol: YG) 	2SK508 K52 T2B (Symbol: K52) 	2SK515 T1B (Symbol: X33) 	2SK882 GR (Symbol: TGR) 	2SK1740 (Symbol: IJ) 
3SK131 T2 MAS (Symbol: V11) 	CPH3404-TL (Symbol: KD) 	DTA114 EE TL (Symbol: 14) 	DTA114EUA T106 (Symbol: 14) 	DTA144 EE TL (Symbol: 16) 
DTB123 EK T146 (Symbol: F12) 	DTC114 EE TL (Symbol: 24) 	DTC114EUA T106 (Symbol: 24) 	DTC144 EE TL (Symbol: 26) 	DTC144 TE (Symbol: 06) 

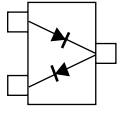
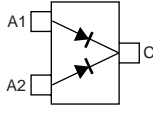
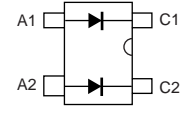
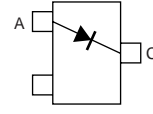
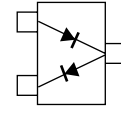
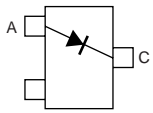
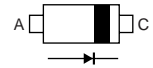
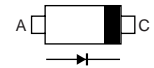
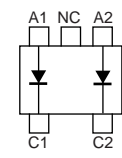
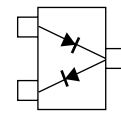
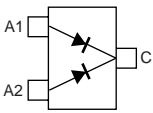
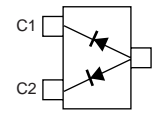
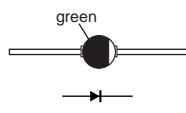
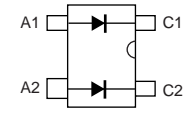
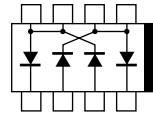
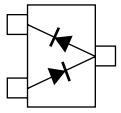
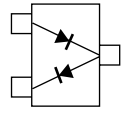
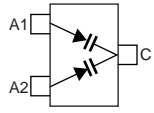
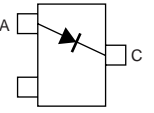
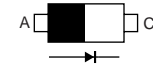
MMBFU310LT1 (Symbol: 6C) 	UMD3N (Symbol: D3) 	UMH4N TN (Symbol: H4) 	UMH11N TN (Symbol: H11) 	UNR911HJ (Symbol: 6P) 
UNR9211J (Symbol: 8A) 	XP4311 (Symbol: 3X) 			

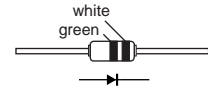
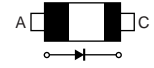
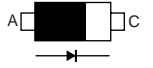
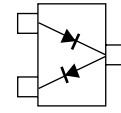
• DIODES

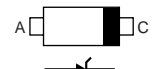
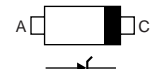
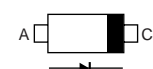
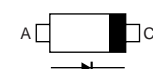
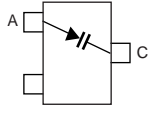
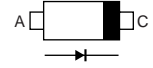
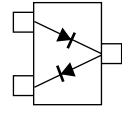
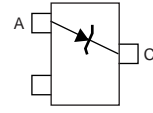
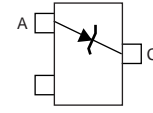
1SS226 (Symbol: C3) 	1SS301 (Symbol: B3) 	1SS319 (Symbol: A4) 	1SS322 (Symbol: A9) 	1SS375-TL (Symbol: FH) 
1SV263 TL (Symbol: JV) 	1SV307 (Symbol: TX) 	1SV308 (Symbol: TX) 	CPH5513 TL (Symbol: 2B) 	DA221 TL (Symbol: K) 
DAN222TL (Symbol: N) 	DAP222 TL (Symbol: P) 	DSA3A1 (Color: Green) 	DWA010 TE (Symbol: W8) 	HSB88WSTR (Symbol: Silver line) 
HSM88ASR TR (Symbol: C3) 	HSM88AS TR (Symbol: C1) 	KV1770S (Symbol: C7) 	MA29B (Symbol: Y) 	MA77 (Symbol: 4B) 
MA114 (Symbol: 1E) 	MA185 (White, Green lines) 	MA338 (Symbol: 6H) 	MA357 (Symbol: 7K) 	MA742 (Symbol: M1U) 
MA8030 H (Symbol: 3^0) 	MA8033 L (Symbol: 3_3) 	MA8051 M (Symbol: 5-1) 	MA2S111 (Symbol: A) 	MA2S728 (Symbol: B) 
MMBV3700LT1 (Symbol: 4R) 	RB050L 40 (Symbol: 35) 	RB706F-40 T106 (Symbol: 3J) 	RD5.1M T2B2 (Symbol: 512) 	RD5.6M T2B2 (Symbol: 562) RD20M T2B1 (Symbol: 201) 

SECTION 8 BOARD LAYOUTS

8-1 DISPLAY BOARD

• TOP VIEW

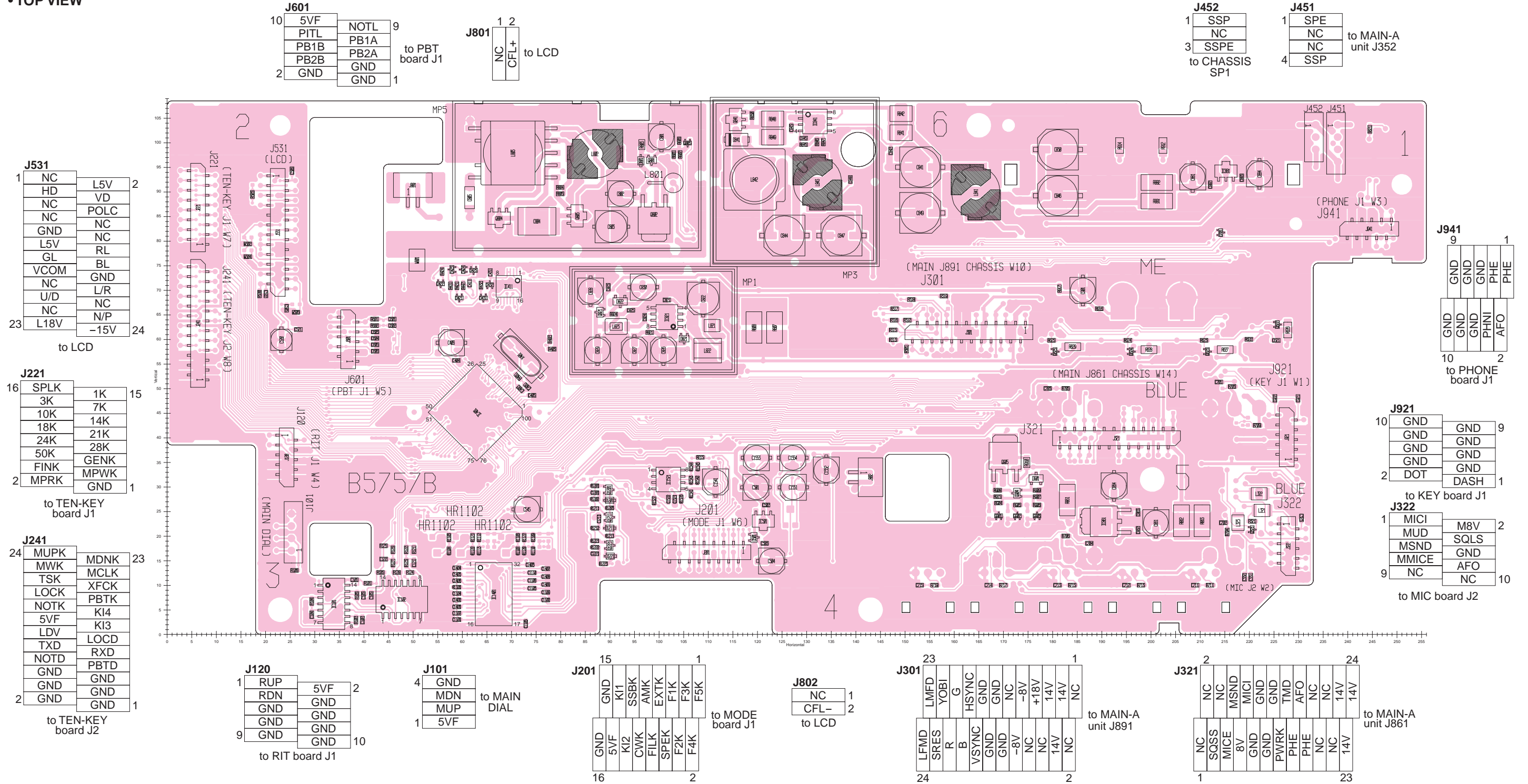

• DISPLAY BOARD (BOTTOM VIEW)

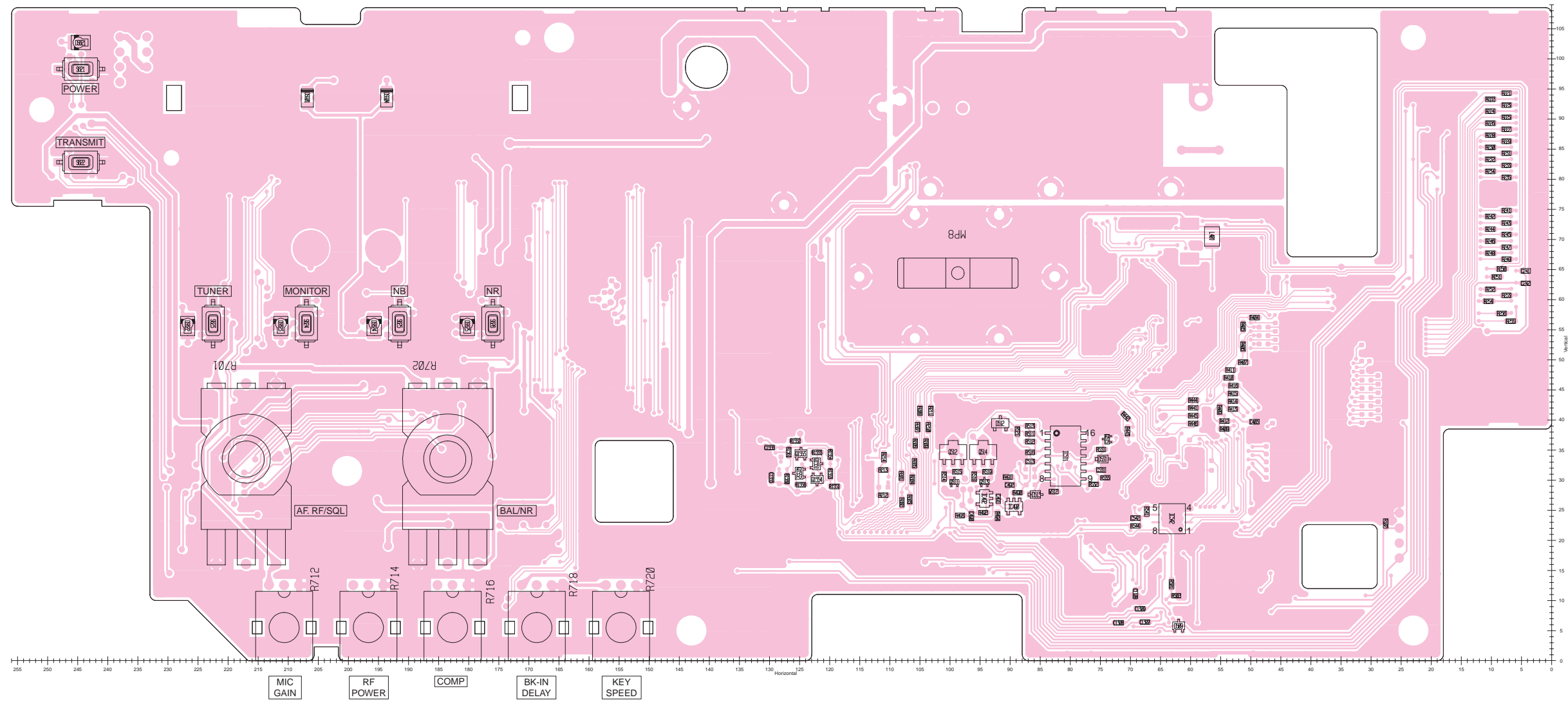

8-2 MODE BOARD • TOP VIEW

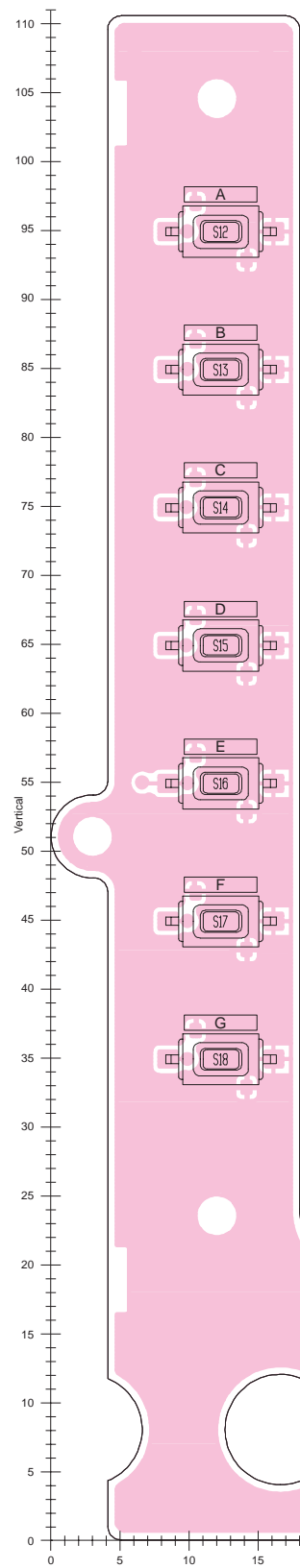

8-3 PHONE BOARD • TOP VIEW

• TOP VIEW

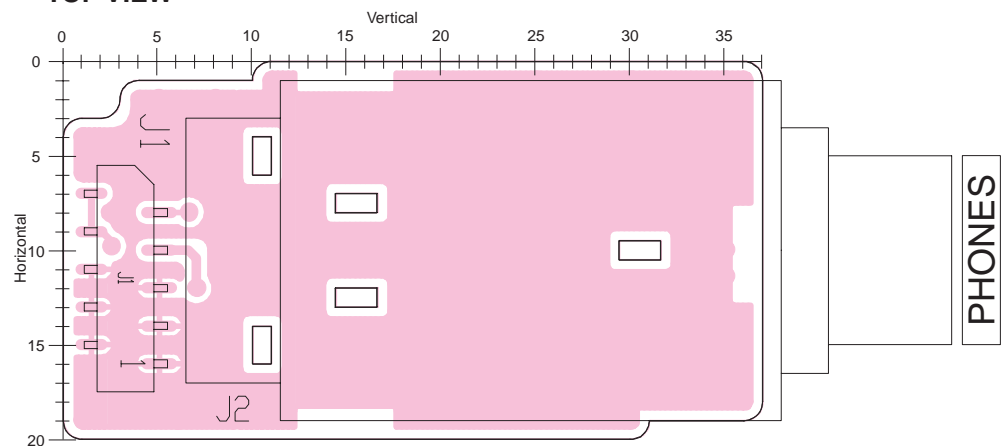

J1

10	PHE	PHO	9
	PHE	PHNI	
	GND	GND	
	GND	GND	
2	GND	GND	1

to DISPLAY board J941

8-4 KEY BOARD • TOP VIEW

• TOP VIEW

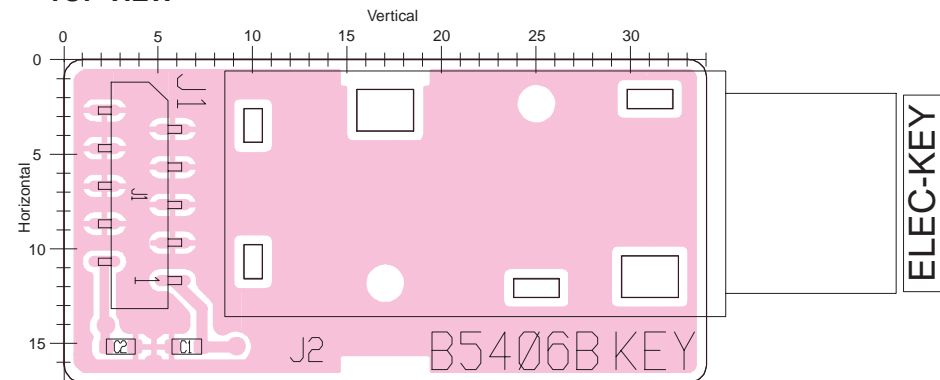

J1

10	GND	GND	9
	GND	GND	
	GND	GND	
	GND	GND	
2	DOT	DASH	1

to DISPLAY board J921

8-5 TEN-KEY BOARD • TOP VIEW

• TOP VIEW

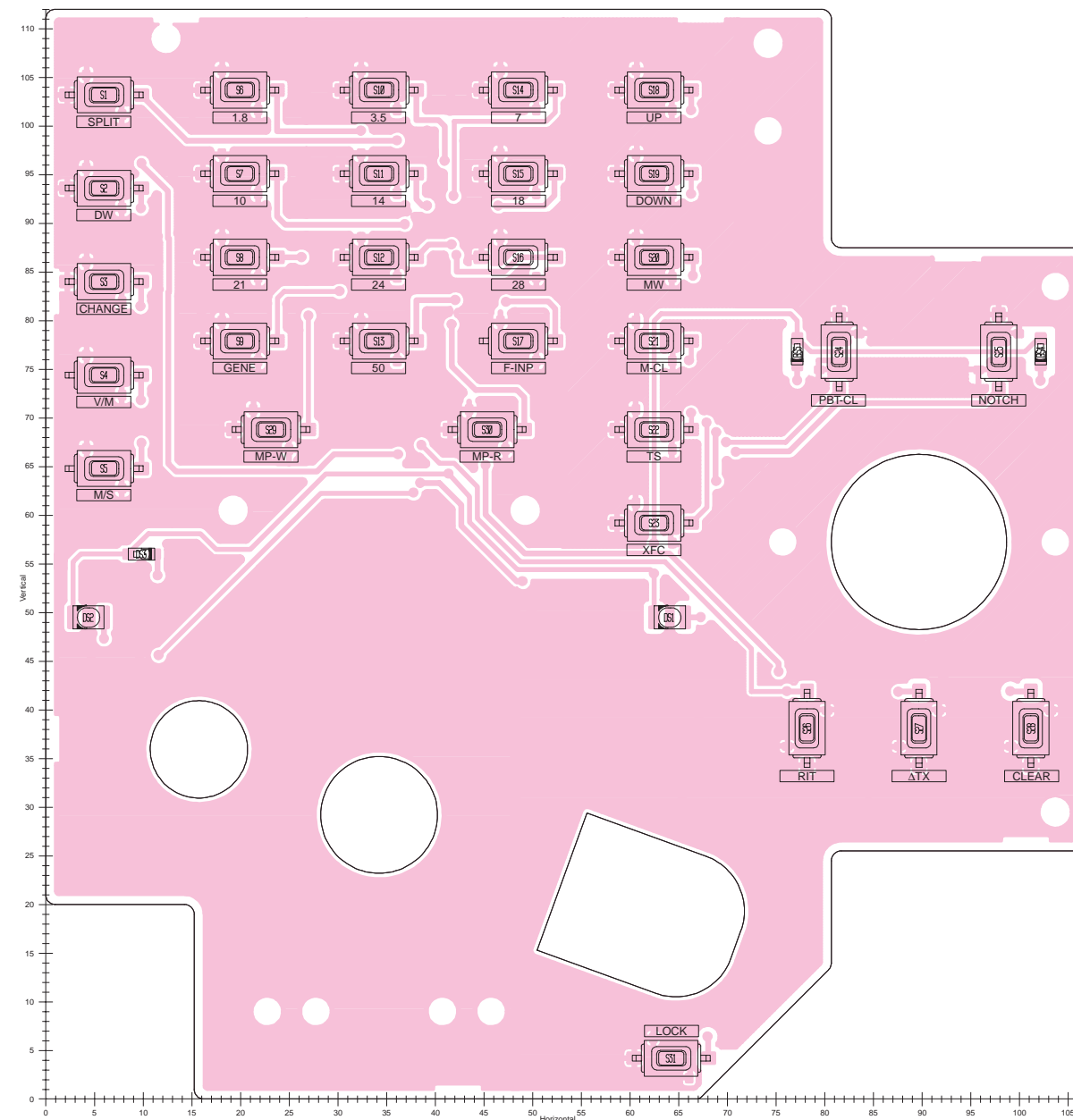

• TEN-KEY BOARD (BOTTOM VIEW)

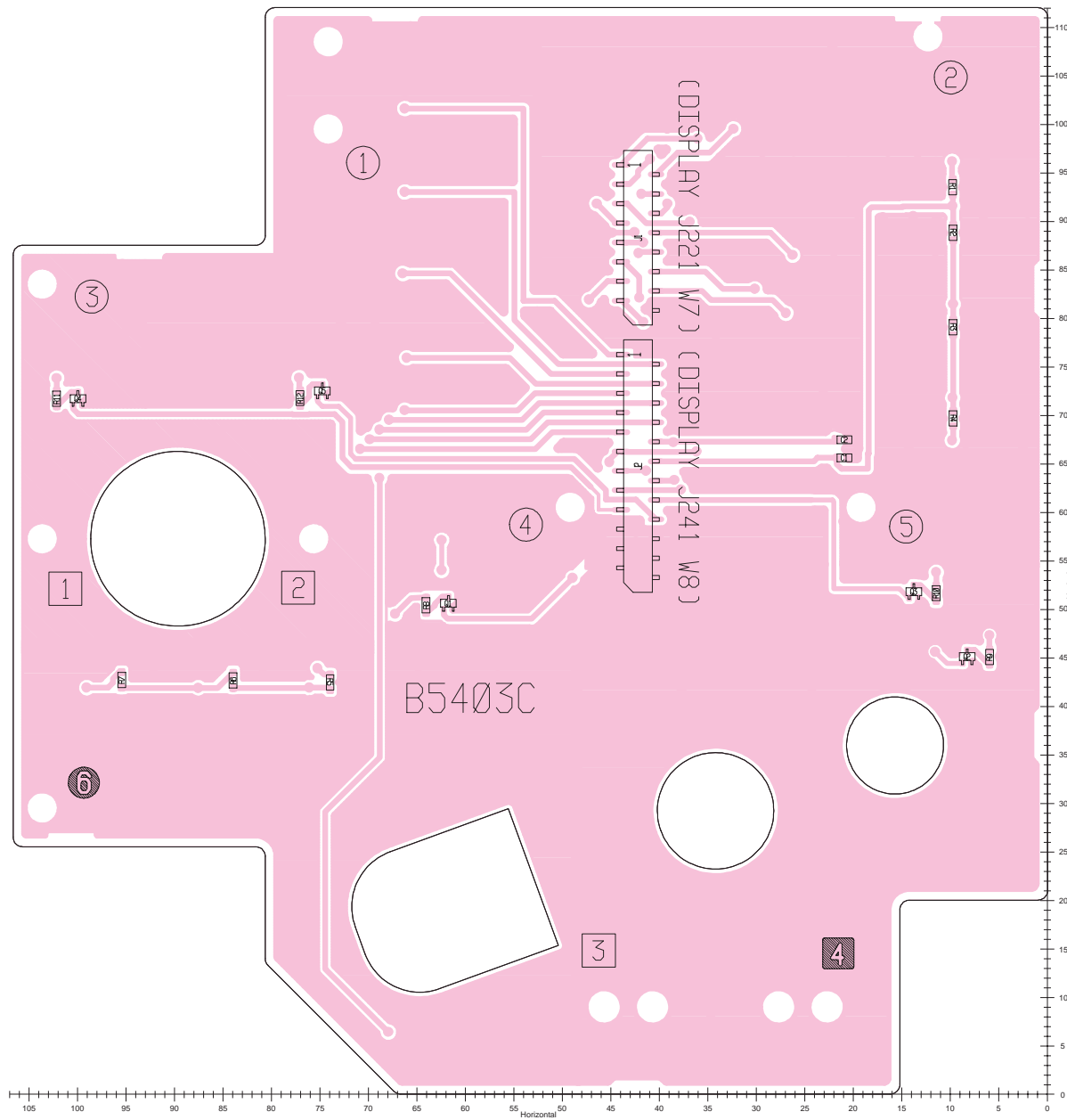

J1

1	SPLK	1K	2
	3K	7K	
	10K	14K	
	18K	21K	
	24K	28K	
	50K	GENK	
	FINK	MPWK	
15	MPRK	GND	16

to DISPLAY board J221

J2

1	MUPK	MDNK	2
	MWK	MCLK	
	TSK	XFCK	
	LOCK	PBTK	
	NOTK	KI4	
	5VF	KI3	
	LDV	LOCD	
	TXD	RXD	
	NOTD	PBTD	
	GND	GND	
	GND	GND	
23	GND	GND	24

to DISPLAY board J241

• PHONE BOARD (BOTTOM VIEW)

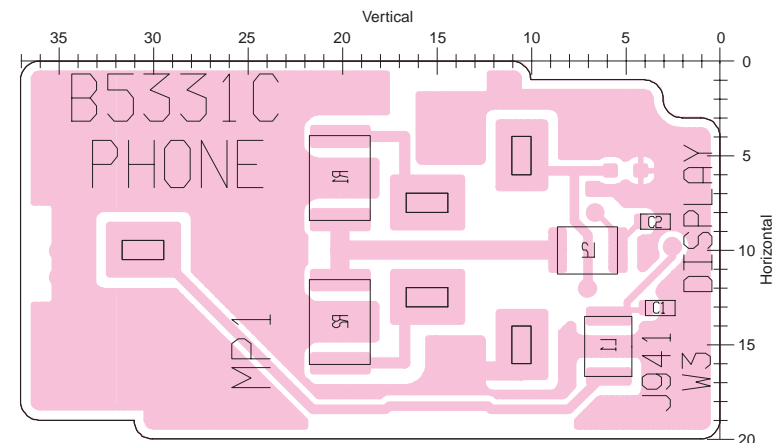

• MODE BOARD (BOTTOM VIEW)

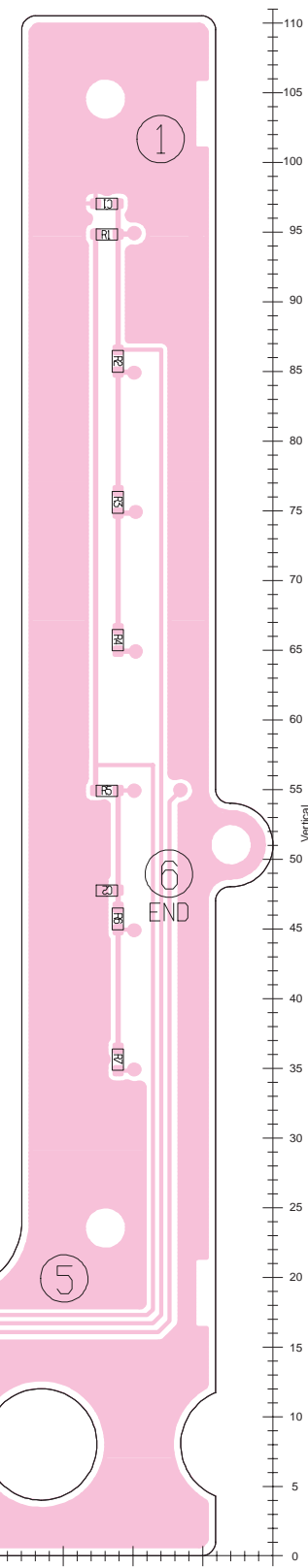

• KEY BOARD (BOTTOM VIEW)

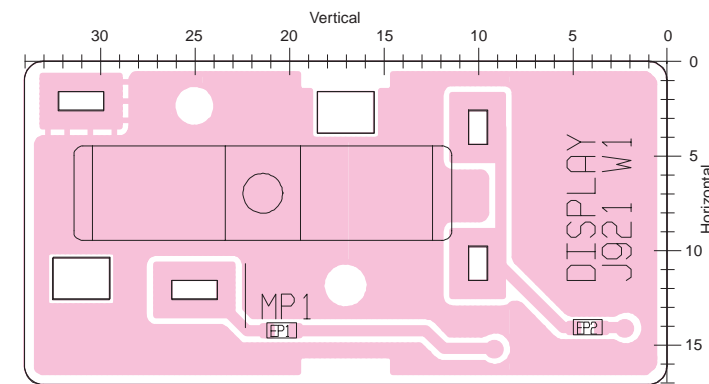

J1

2	GND	16
	KI1	
	SSBK	
	AMK	
	EXTK	
	F1K	
	F3K	
	F5K	
1	GND	15
	5VF	
	KI2	
	CWK	
	FILK	
	SPEK	
	F2K	
	F4K	

to DISPLAY board J201

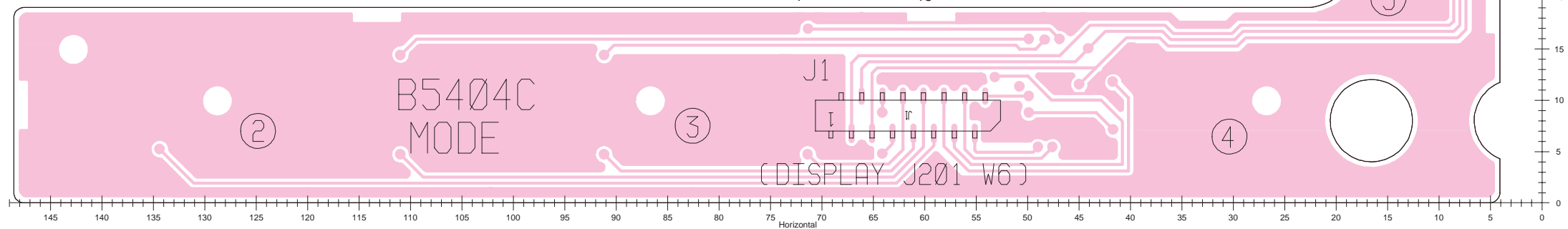

8-6 PBT BOARD

• TOP VIEW

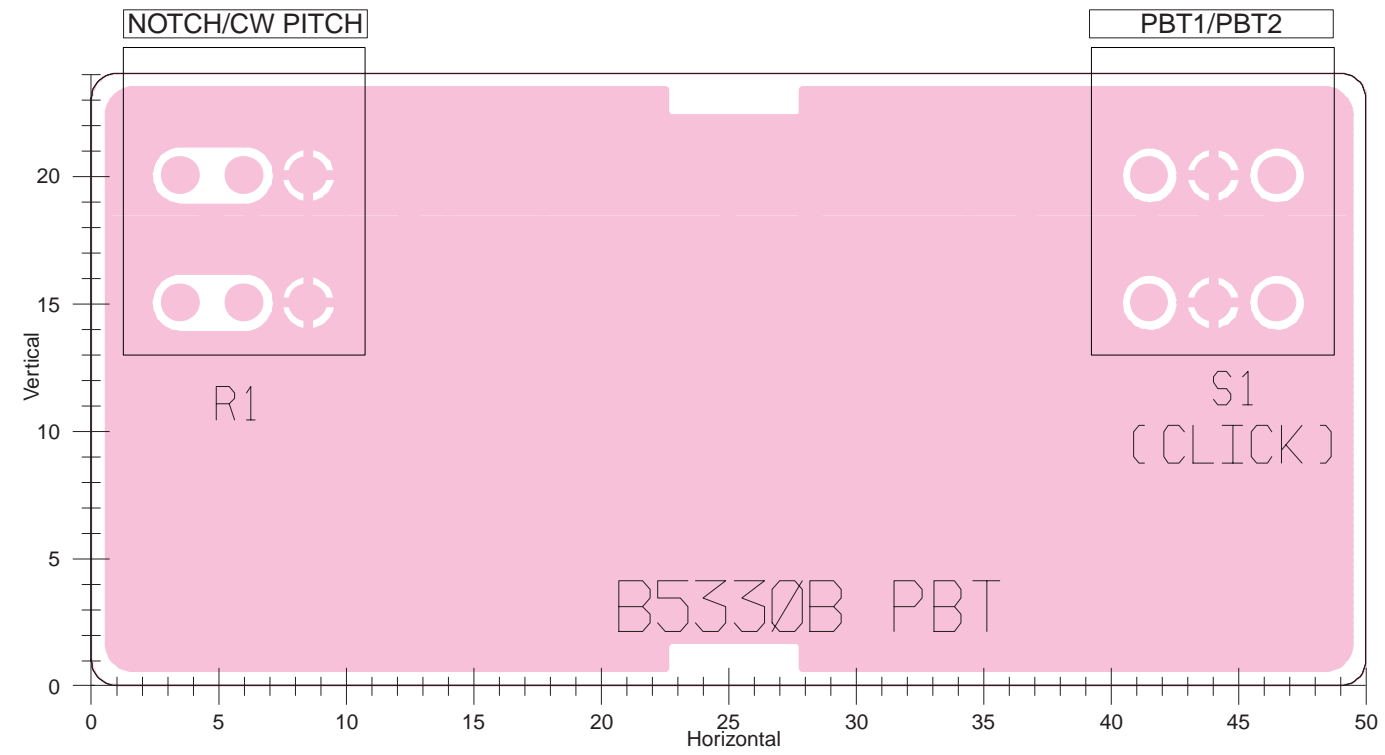

8-9 MEMORY BOARD

• TOP VIEW

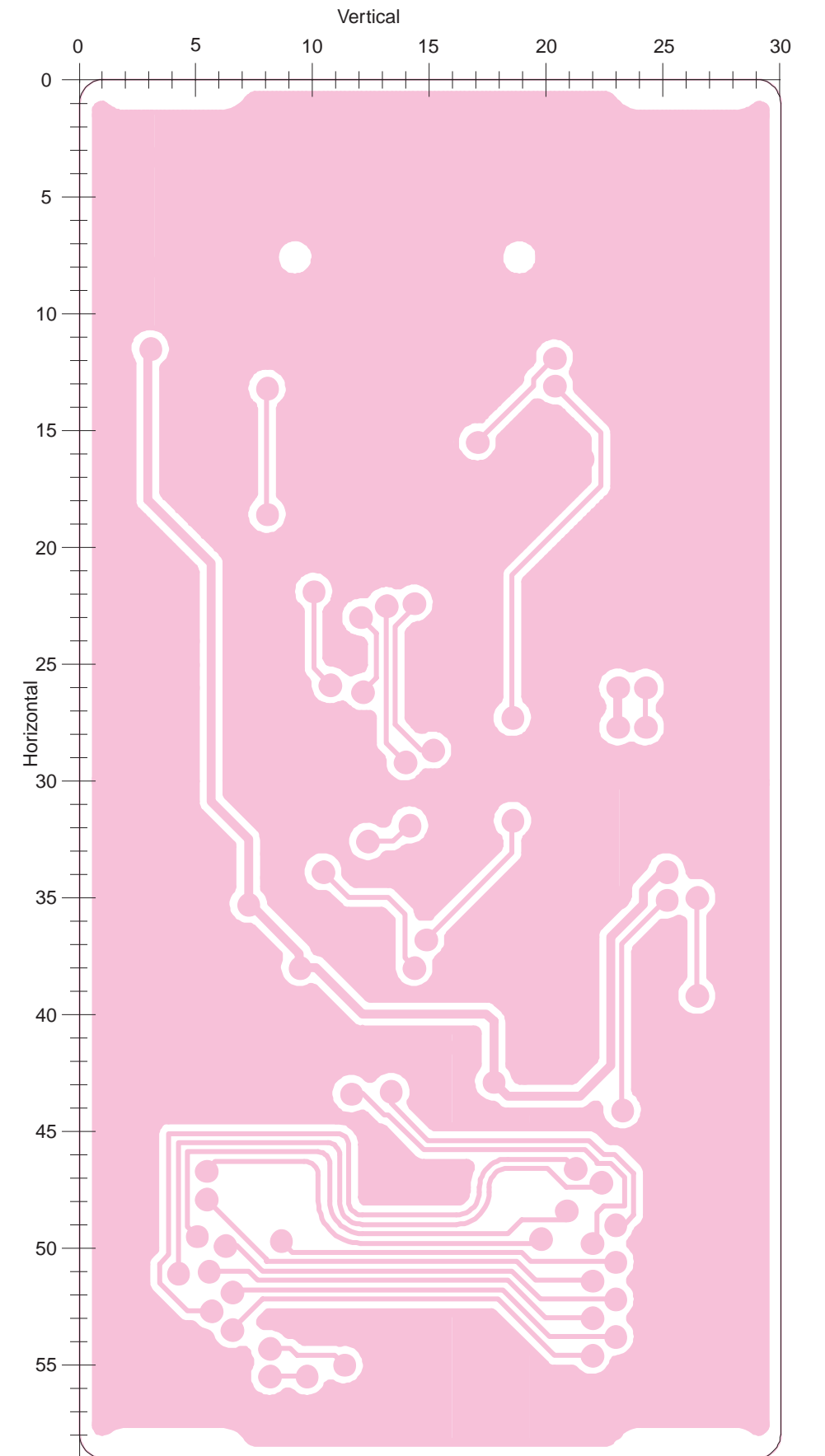

8-7 RIT BOARD

• TOP VIEW

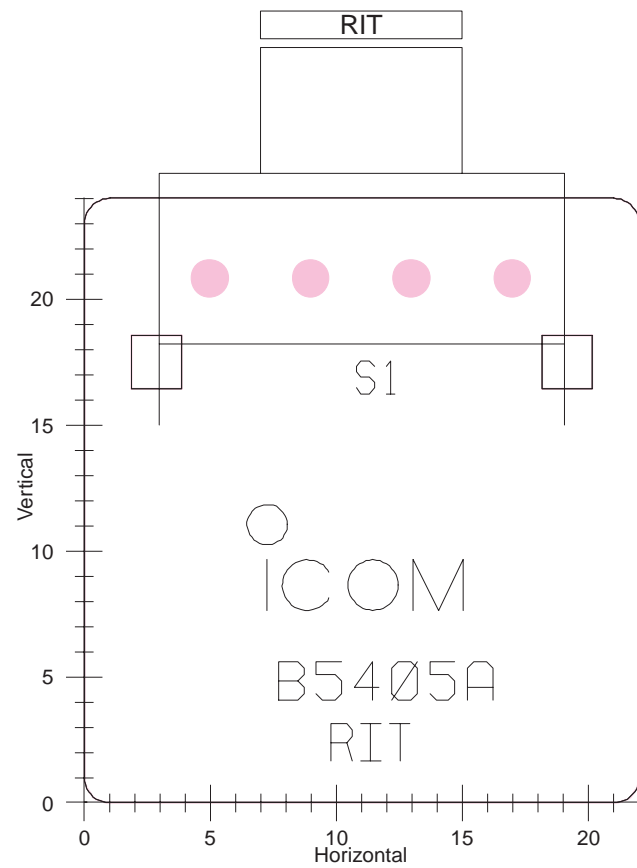

8-8 MIC BOARD

• TOP VIEW

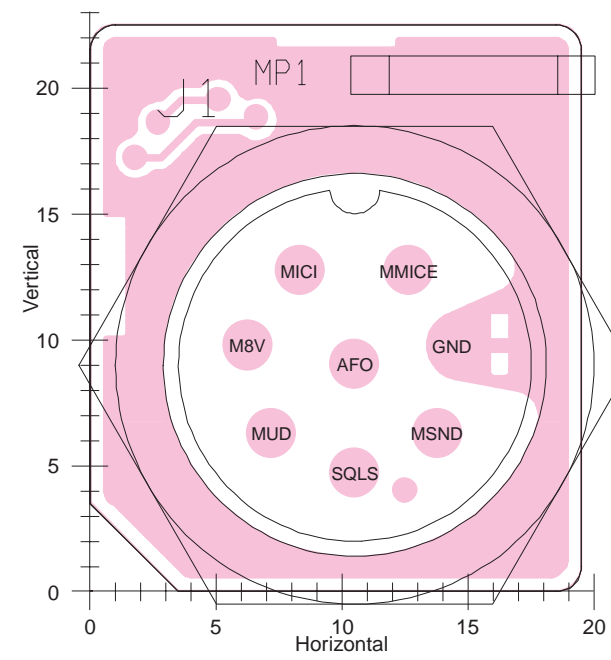

• MEMORY BOARD (BOTTOM VIEW)

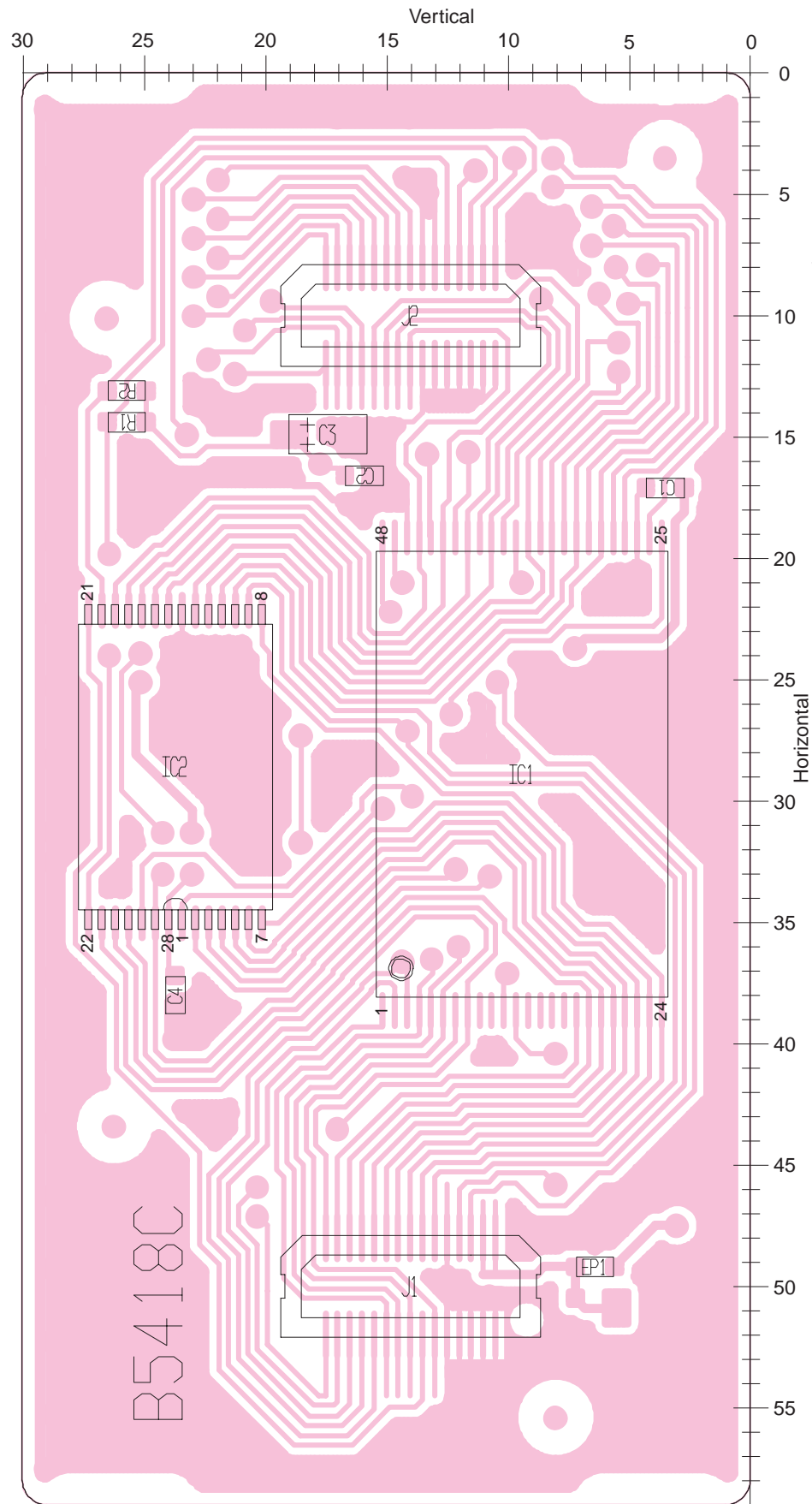

1	D7	15
J2	D6	
	D5	
	D4	
	D3	
	D2	
	D1	
	D0	
	GND	
	GND	
	GND	
	HWR	
	RD	
	RD	
	GND	
	CSs	
	GND	
30	GND	16

to MAIN-A unit J3504

1	A9	15
J1	A8	
	A7	
	A6	
	A5	
	A4	
	A3	
	A2	
	A1	
	A10s	
	A10f	
	GND	
	RESET	
	BYTE	
	GND	
	VCC	
30	GND	16

to MAIN-A unit J3503

• PBT BOARD (BOTTOM VIEW)

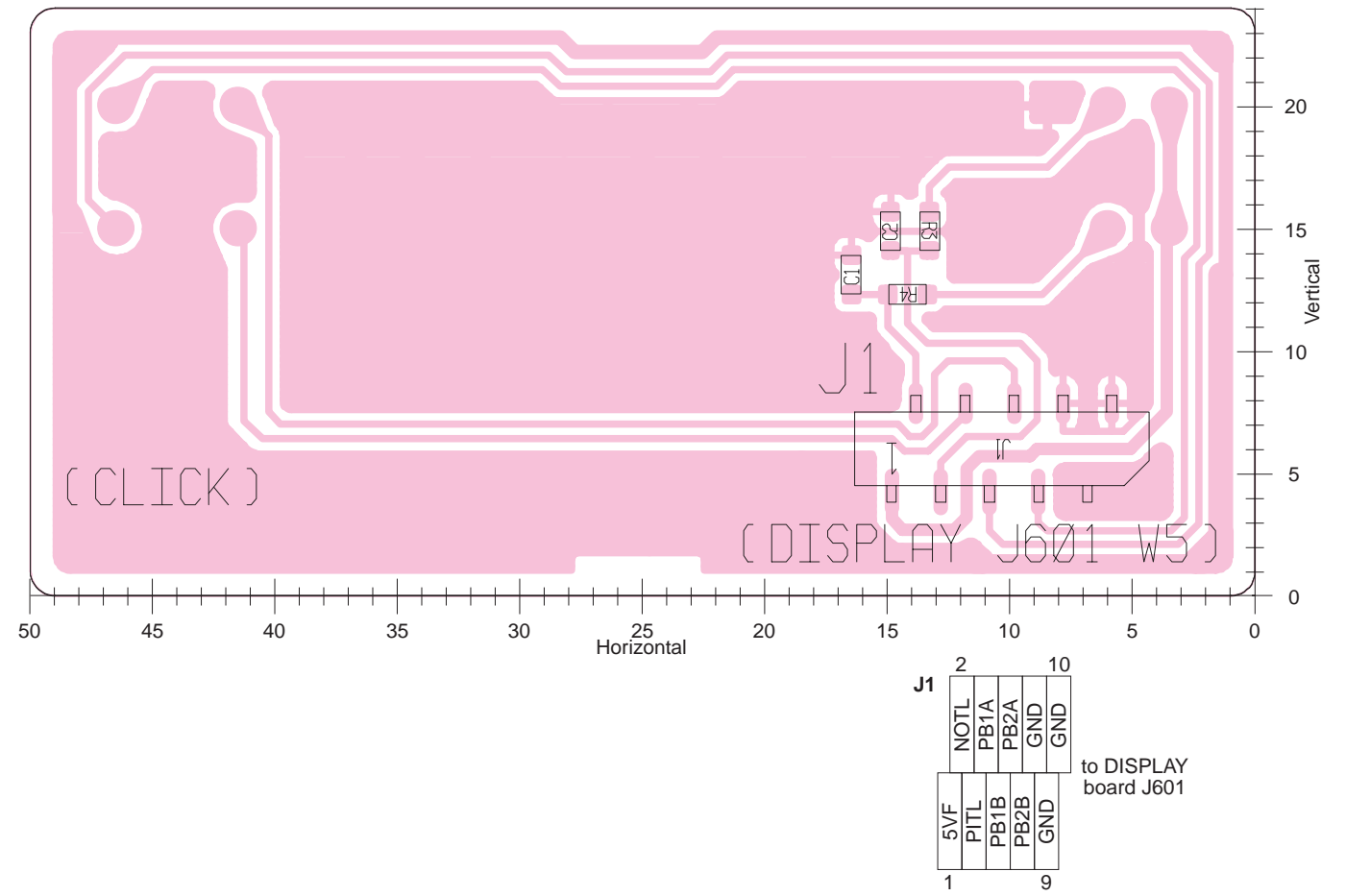

2	NOTL	10
J1	PB1A	
	PB2A	
	GND	
	GND	
1	5VF	9
	PITL	
	PB1B	
	PB2B	
	GND	

to DISPLAY board J601

• MIC BOARD (BOTTOM VIEW)

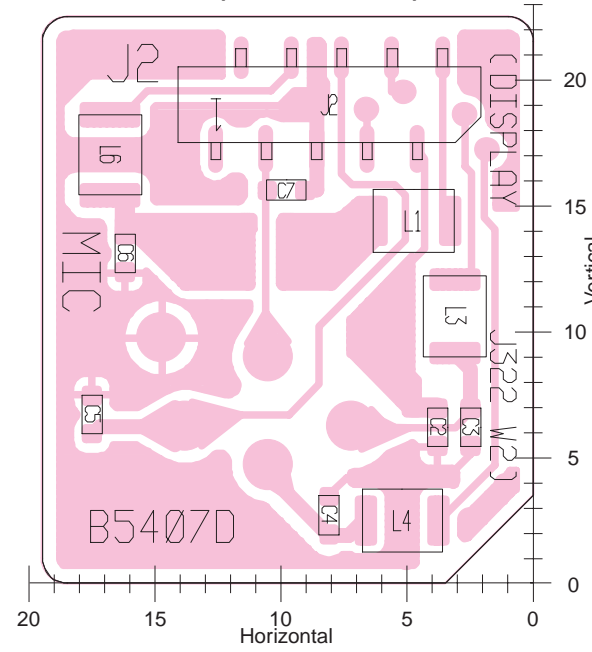

2	NC	10
J2	MMICE	
	MSND	
	MUD	
	M8V	
1	NC	9
	AFO	
	GND	
	SQLS	
	M8V	

to DISPLAY board J322

2	GND	10
J1	GND	
	GND	
	GND	
	RDN	
	RUP	
1	GND	9
	GND	
	5VF	

to DISPLAY board J120

• RIT BOARD (BOTTOM VIEW)

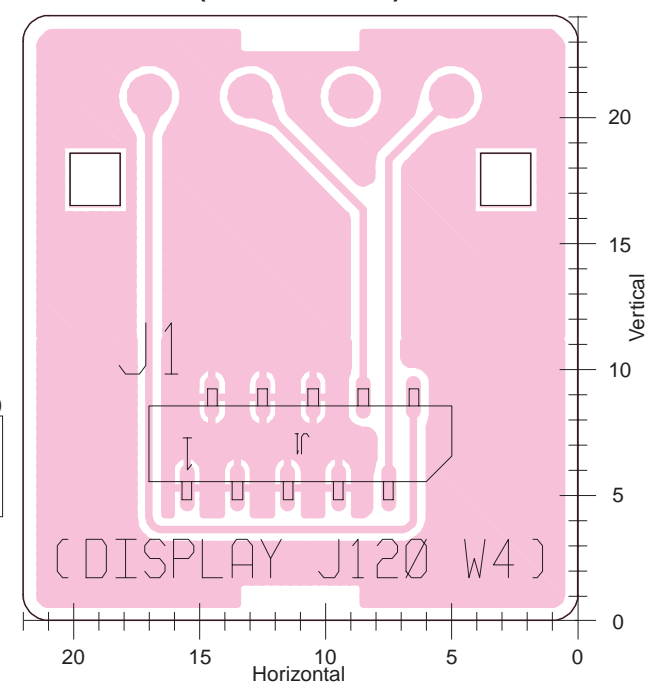

• MAIN-A UNIT (BOTTOM VIEW)

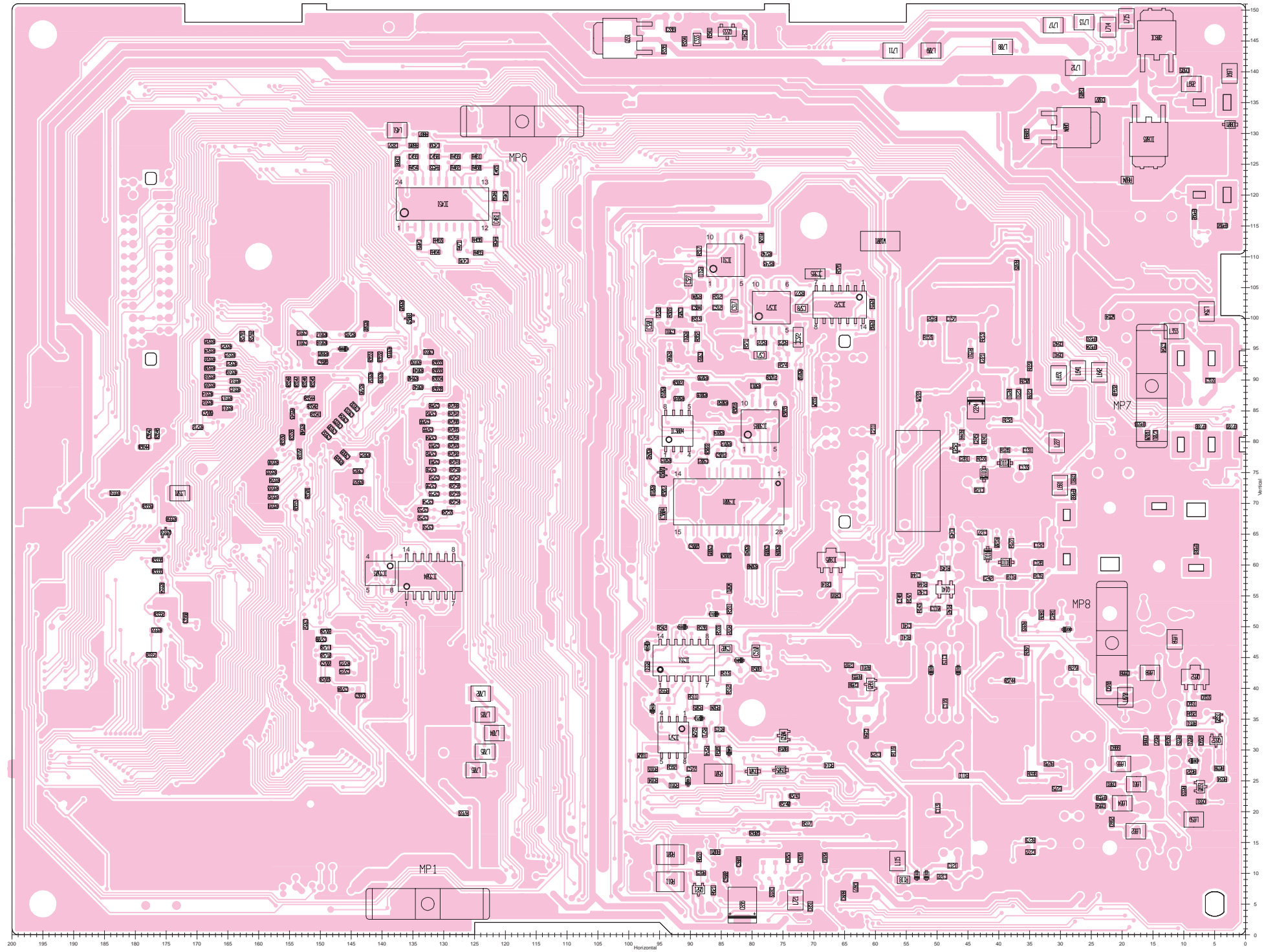

• DSP-A BOARD (BOTTOM VIEW)

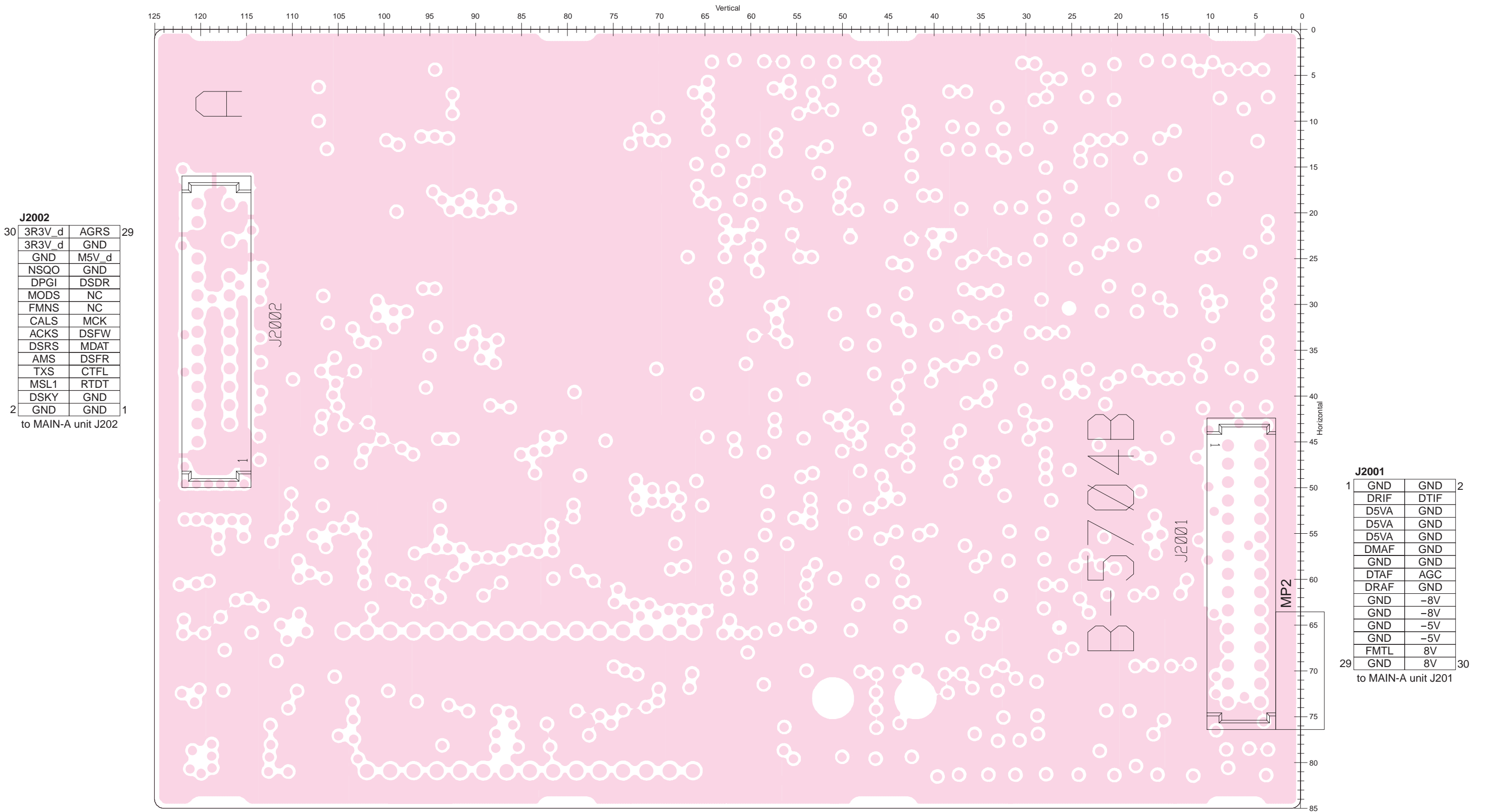

J2002

30	3R3V_d	AGRS	29
	3R3V_d	GND	
	GND	M5V_d	
	NSQO	GND	
	DPGI	DSDR	
	MODS	NC	
	FMNS	NC	
	CALS	MCK	
	ACKS	DSFW	
	DSRS	MDAT	
	AMS	DSFR	
	TXS	CTFL	
	MSL1	RTDT	
2	DSKY	GND	1
	GND	GND	

to MAIN-A unit J202

J2001

1	GND	GND	2
	DRIF	DTIF	
	D5VA	GND	
	D5VA	GND	
	D5VA	GND	
	DMAF	GND	
	GND	GND	
	DTAF	AGC	
	DRAF	GND	
	GND	-8V	
	GND	-8V	
	GND	-5V	
	GND	-5V	
	FMTL	8V	
29	GND	8V	30

to MAIN-A unit J201

8-13 BPF-A BOARD

• TOP VIEW

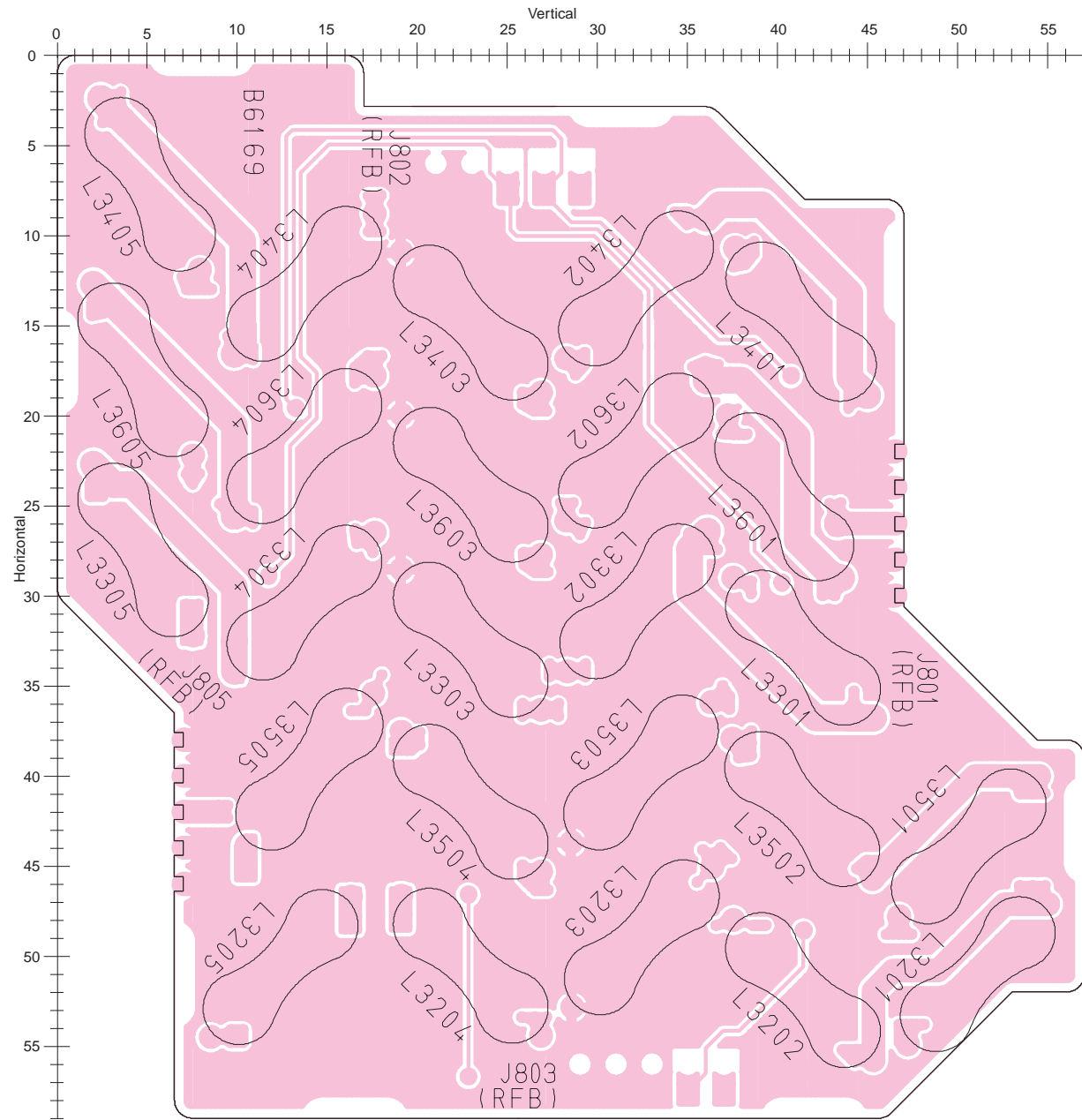

8-14 PREAMP BOARD

• TOP VIEW

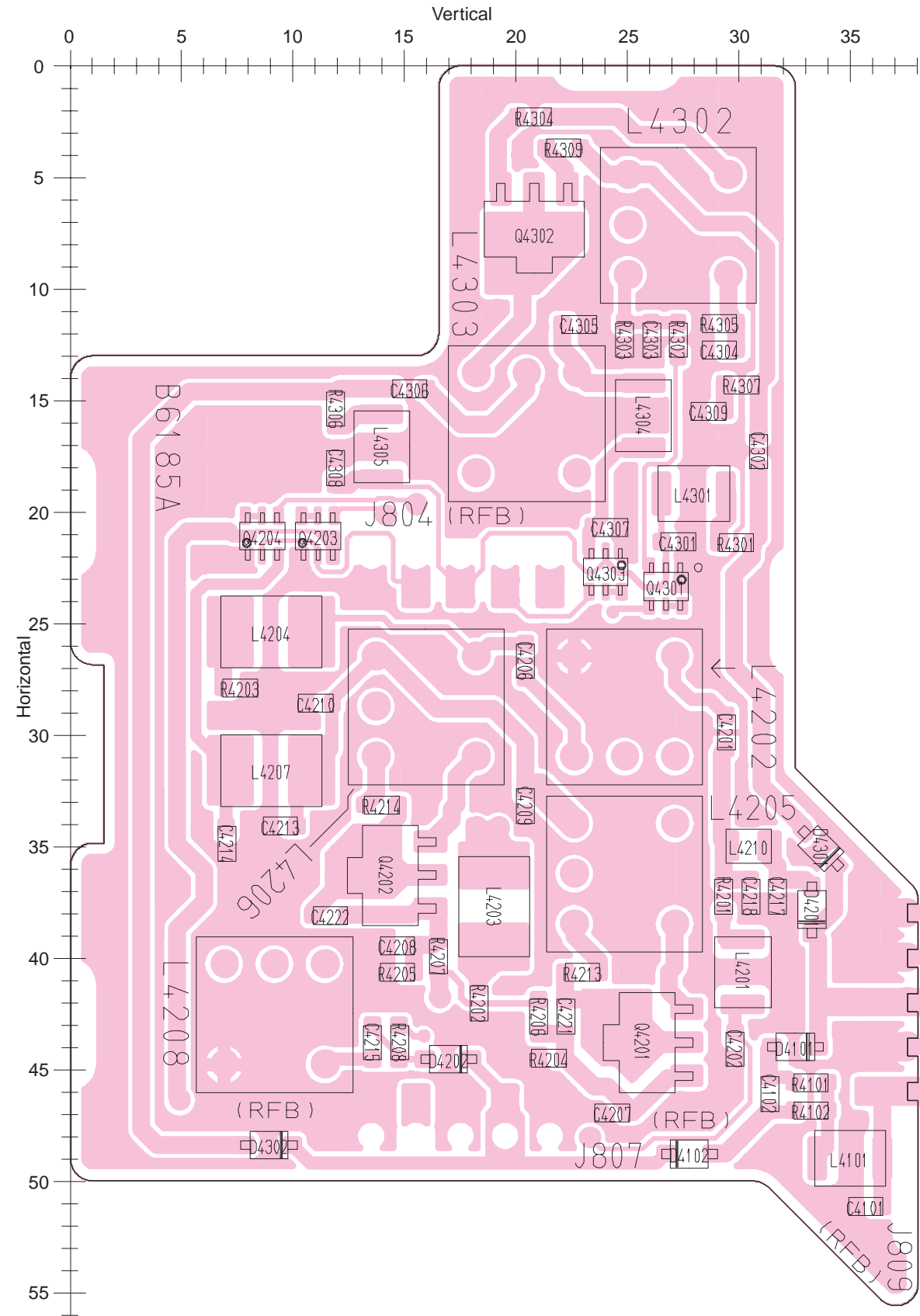

• PREAMP BOARD (BOTTOM VIEW)

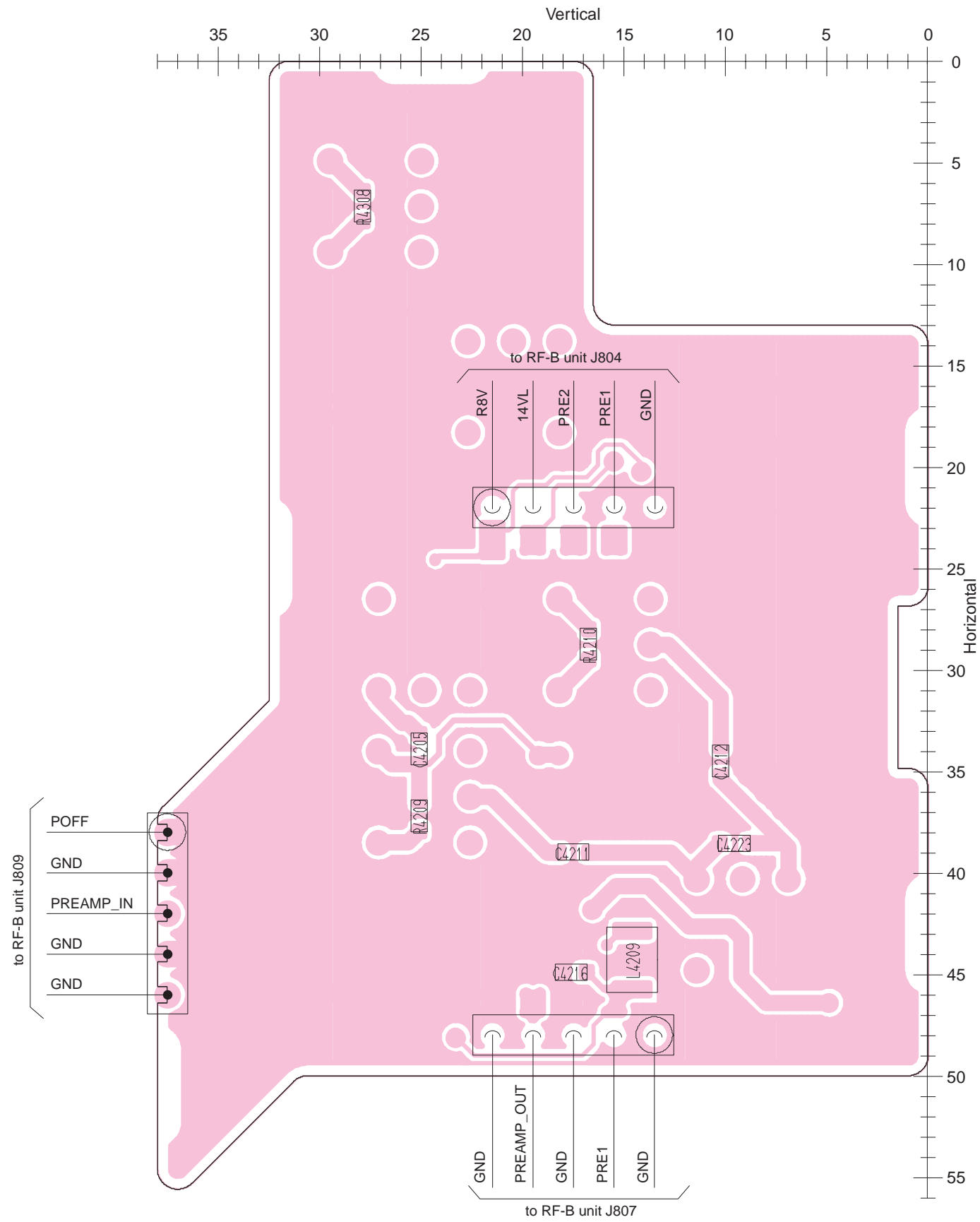

• BPF-A BOARD (BOTTOM VIEW)

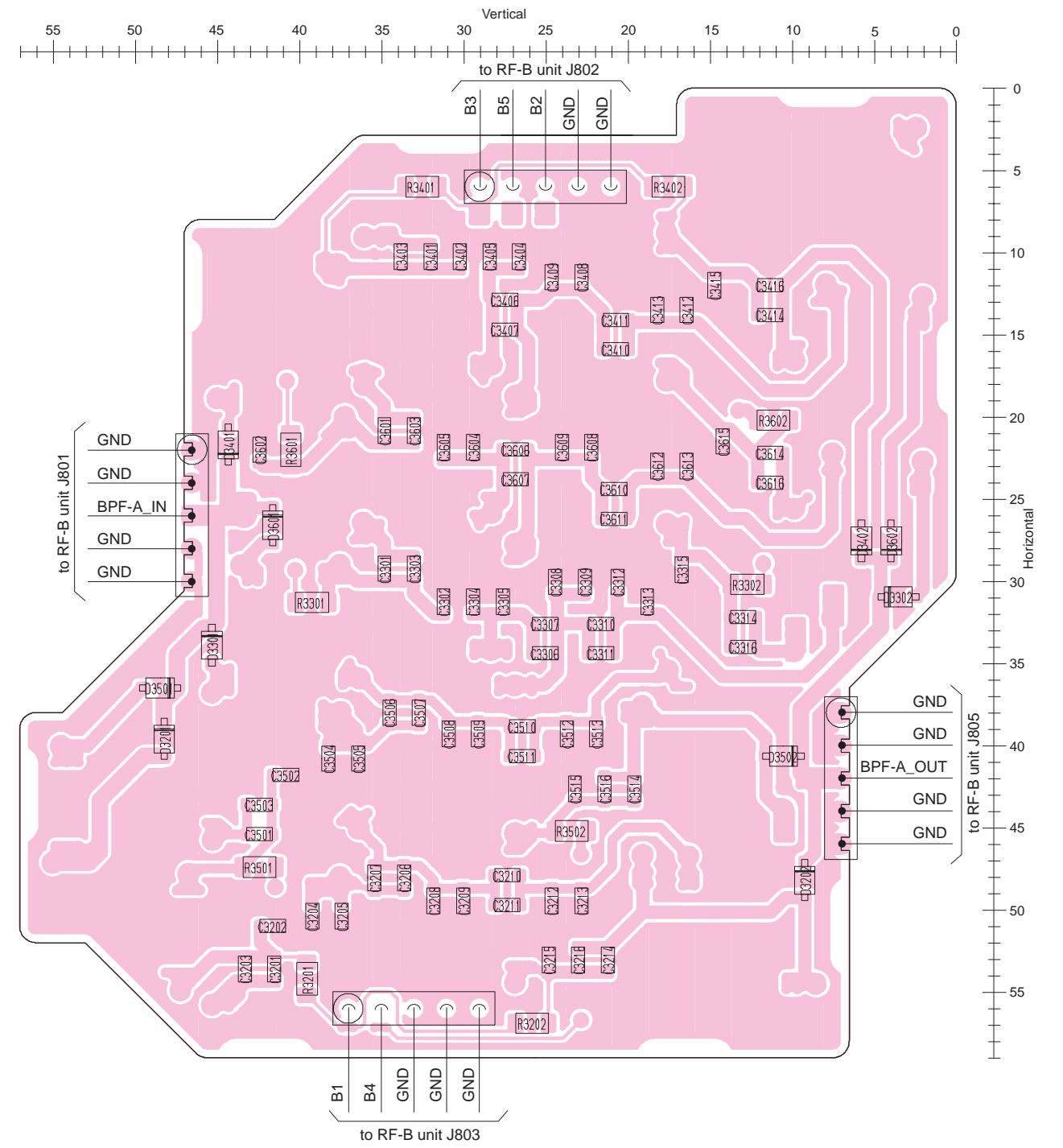

• PLL UNIT (BOTTOM VIEW)

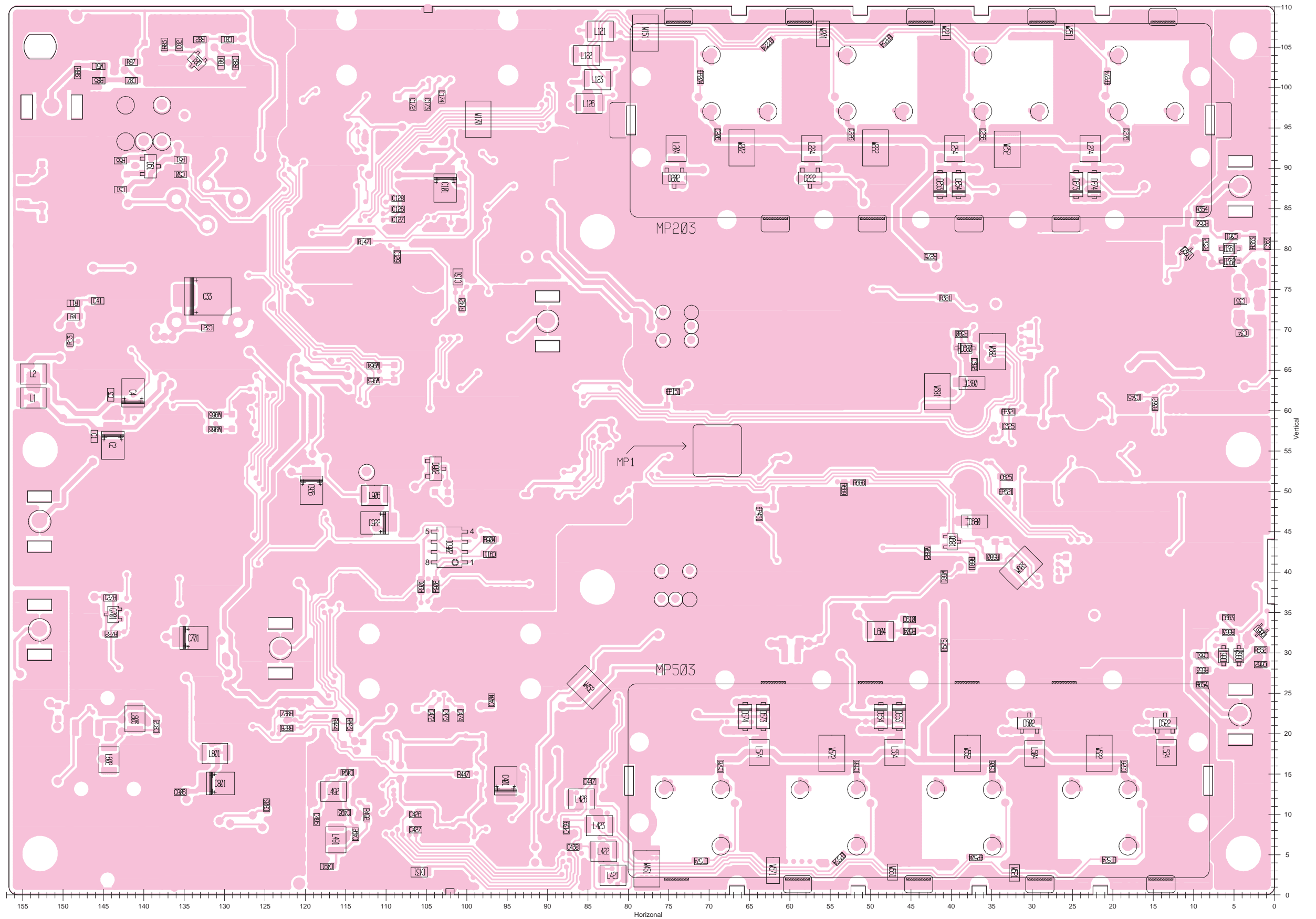

8-16 PA UNIT
•TOP VIEW

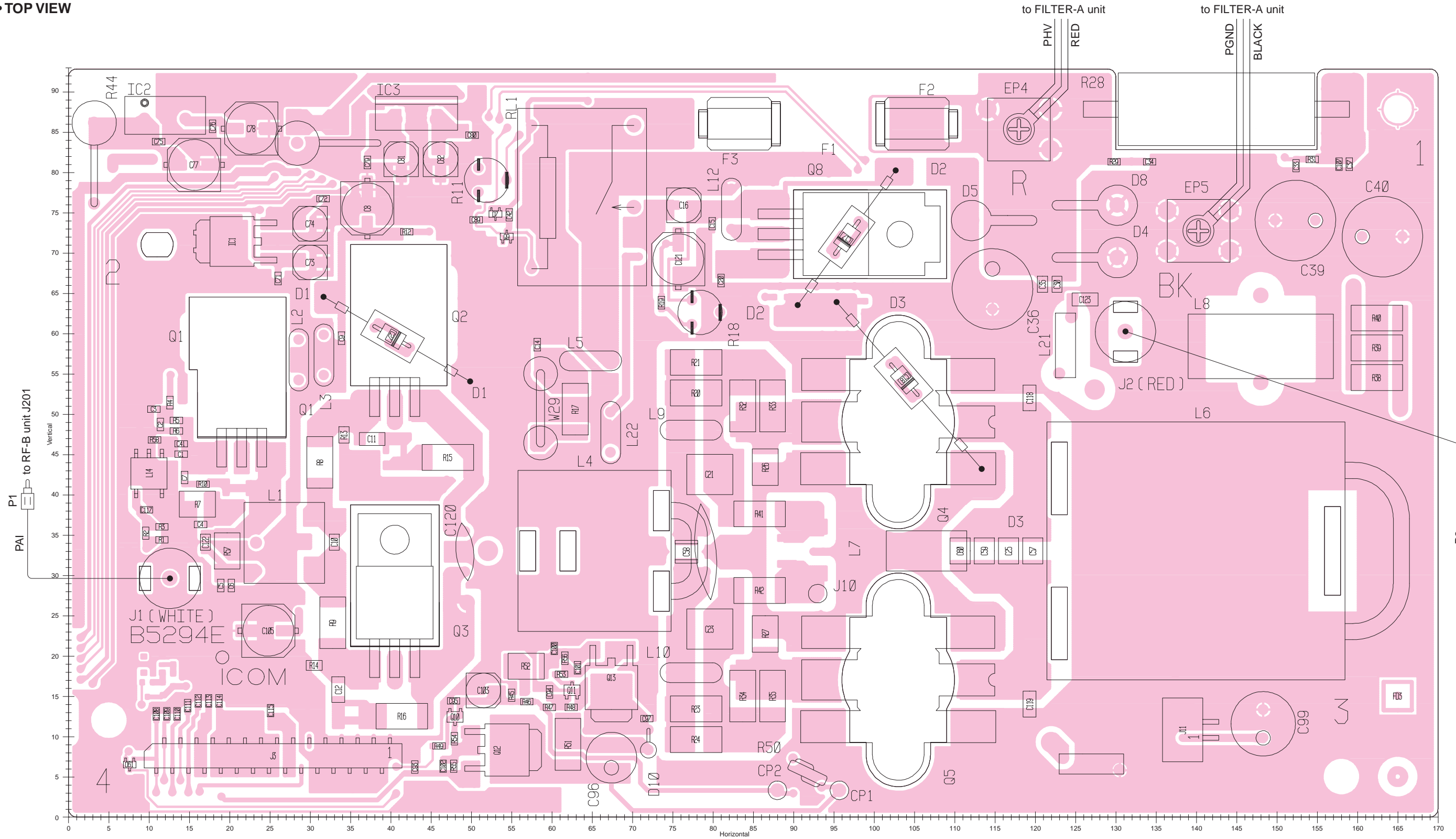

29	1
J3	
PWRS	
ICL	
ICH	
8V	
14VA	
14V	
14V	
14V	
14V	
5V	
5V	
HV	
NC	
GND	
GND	
GND	
GND	
GND	
GND	
30	2

to MAIN-A unit J771

J11	
MF-	2
MF+	1

to CHASSIS MF1

• PA UNIT (BOTTOM VIEW)

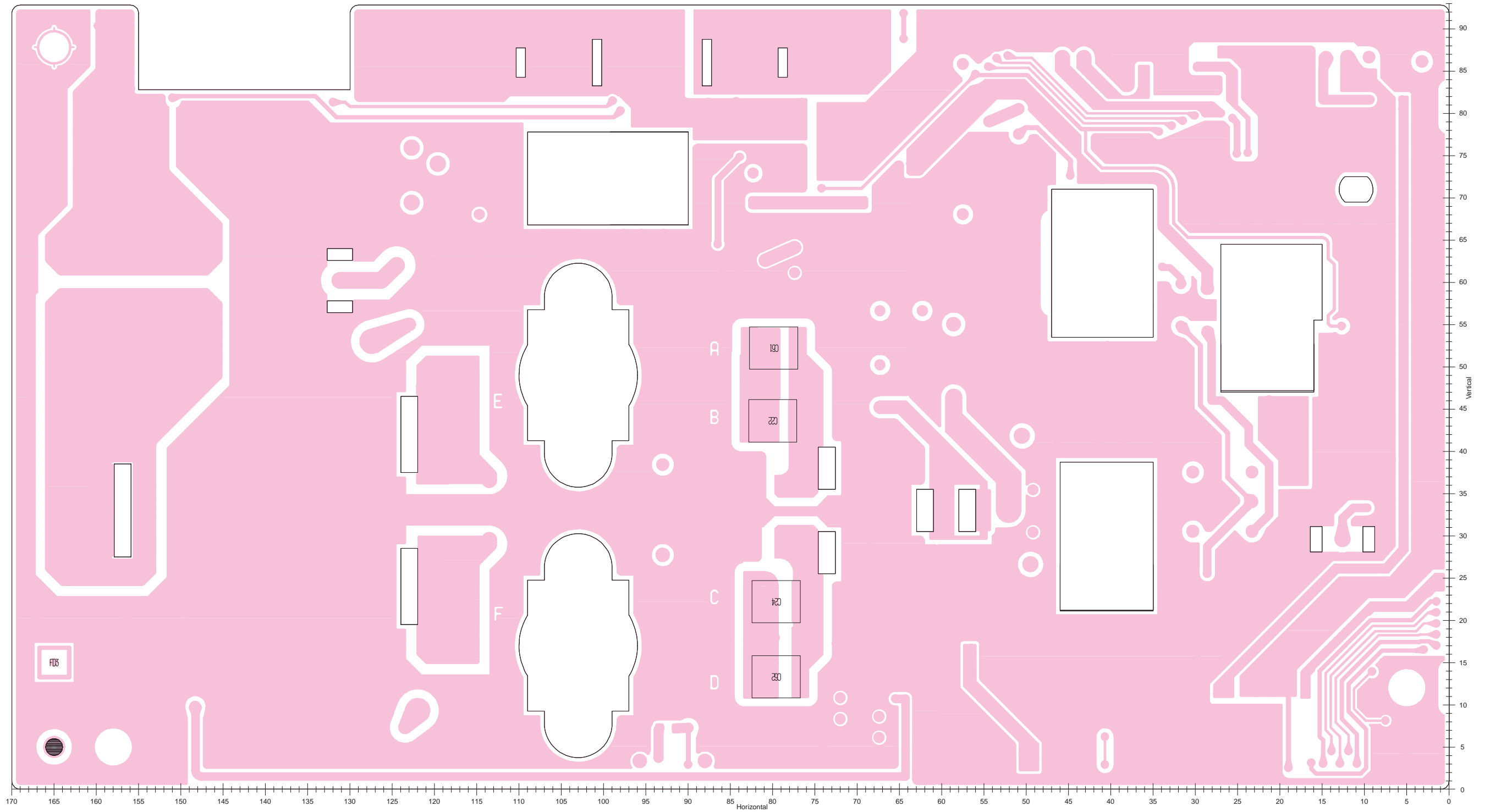

8-17 FILTER-A UNIT
• TOP VIEW

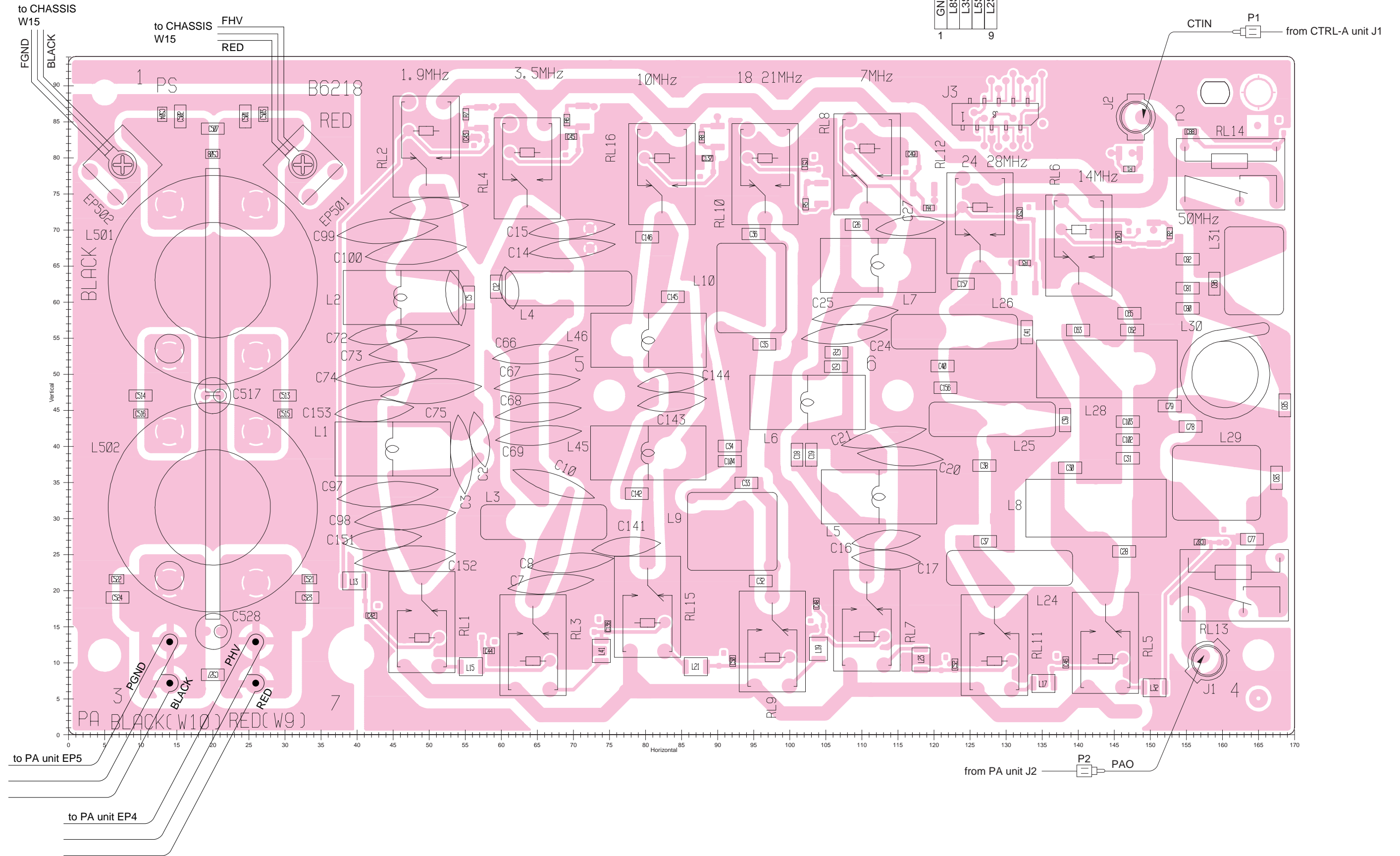
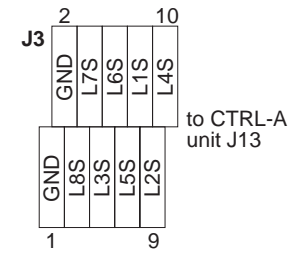

• FILTER-A UNIT (BOTTOM VIEW)

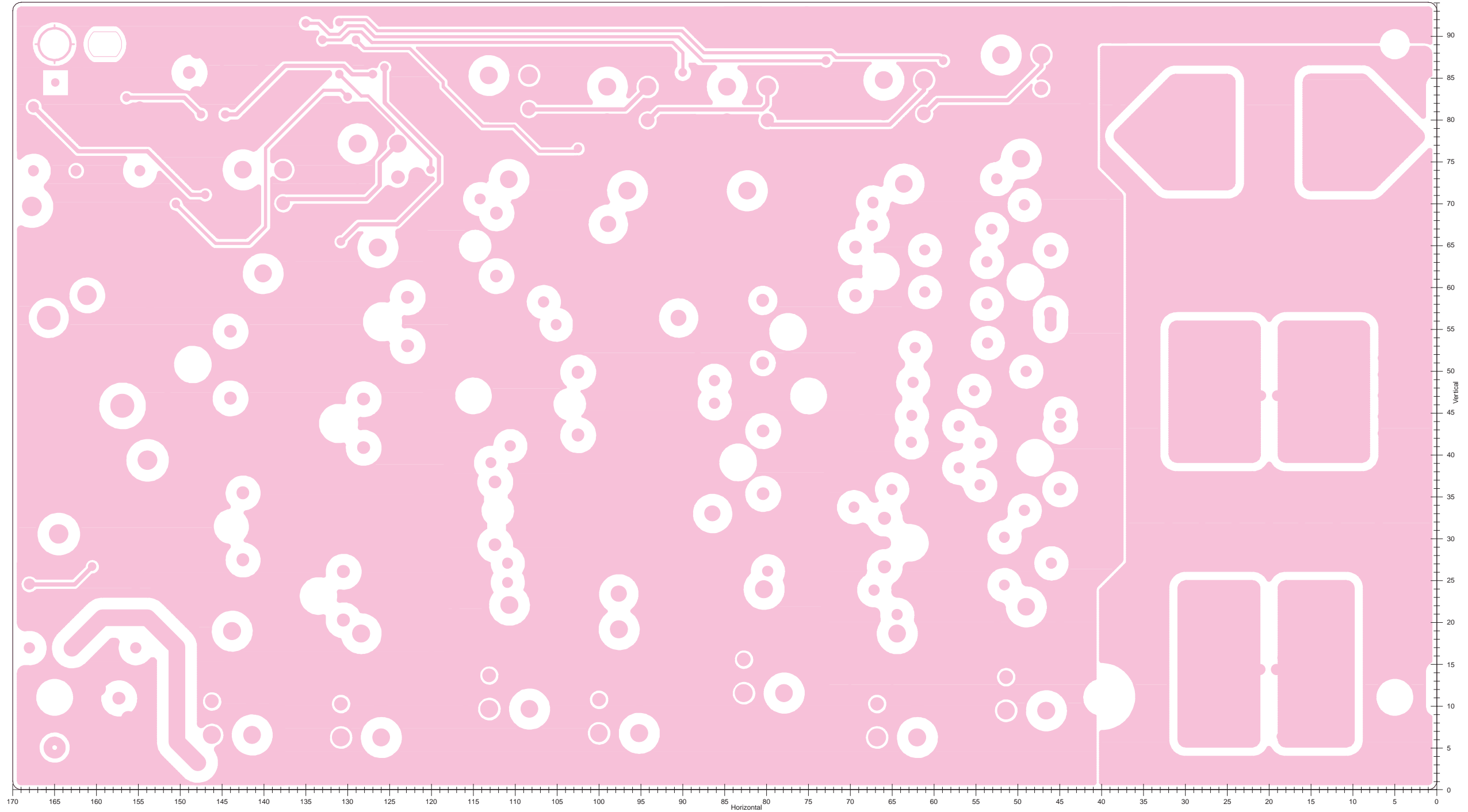

8-18 CTRL-A UNIT
•TOP VIEW

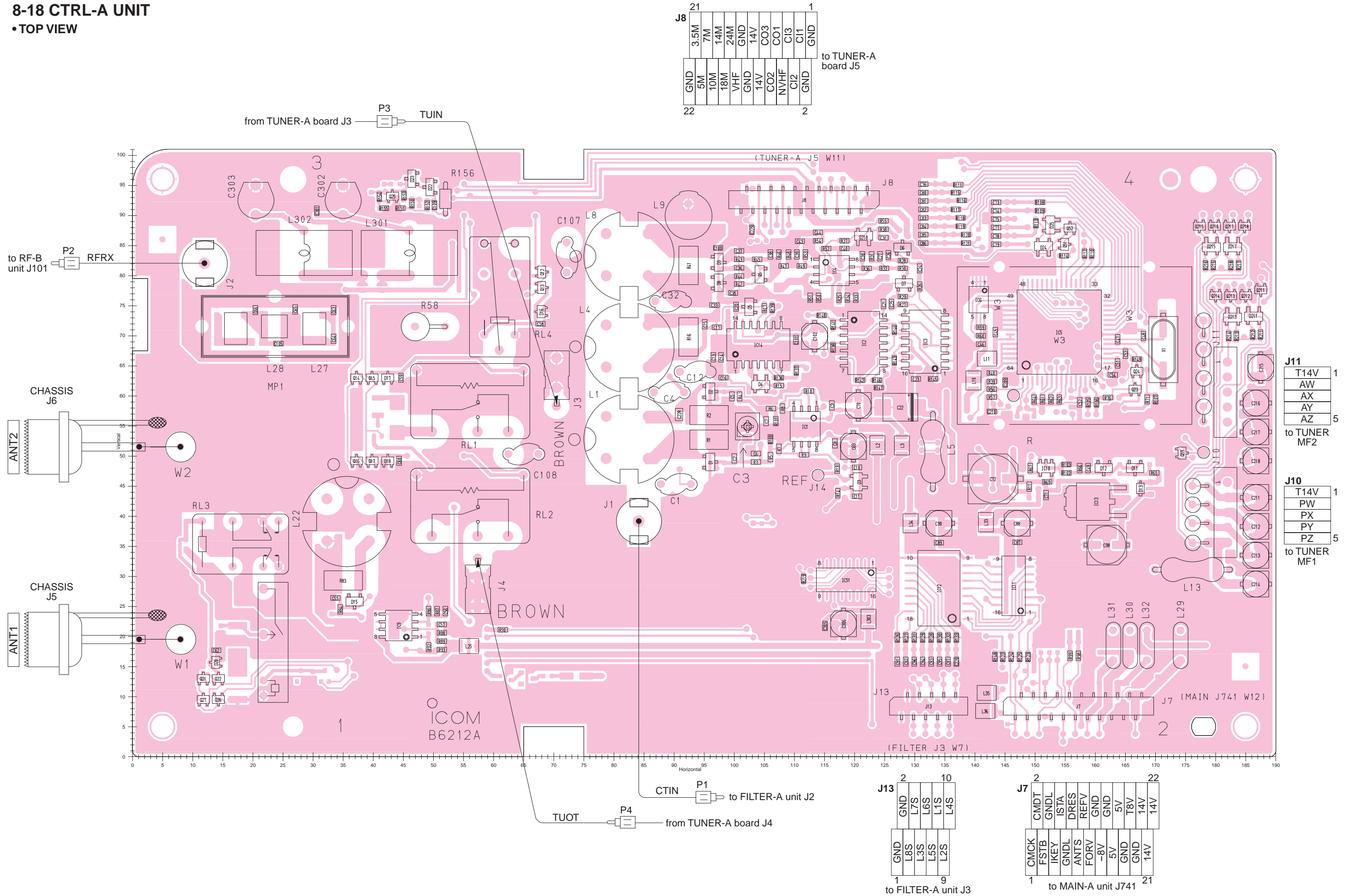

• CTRL-A UNIT (BOTTOM VIEW)

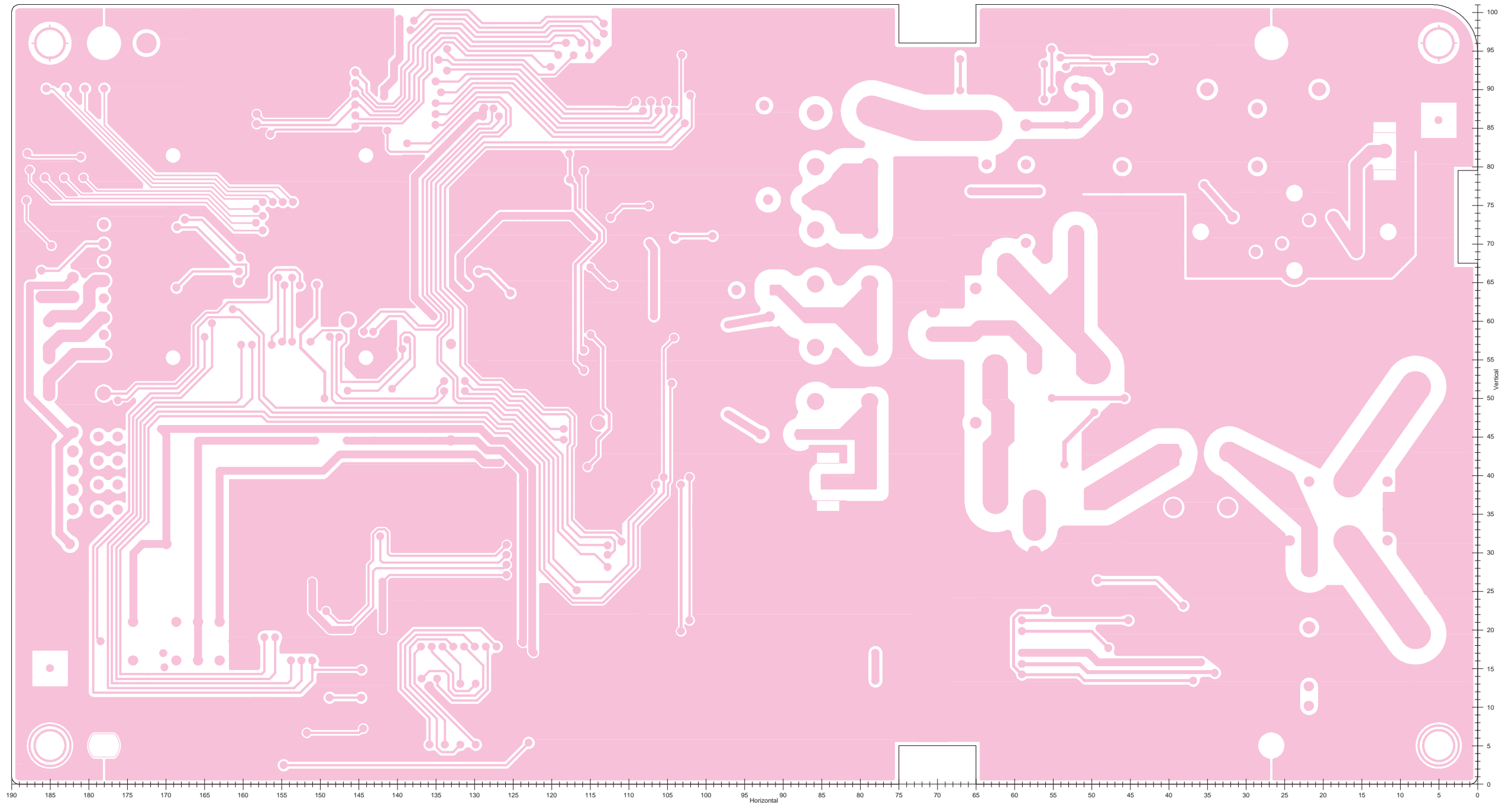

8-19 TUNER-A BOARD
• TOP VIEW

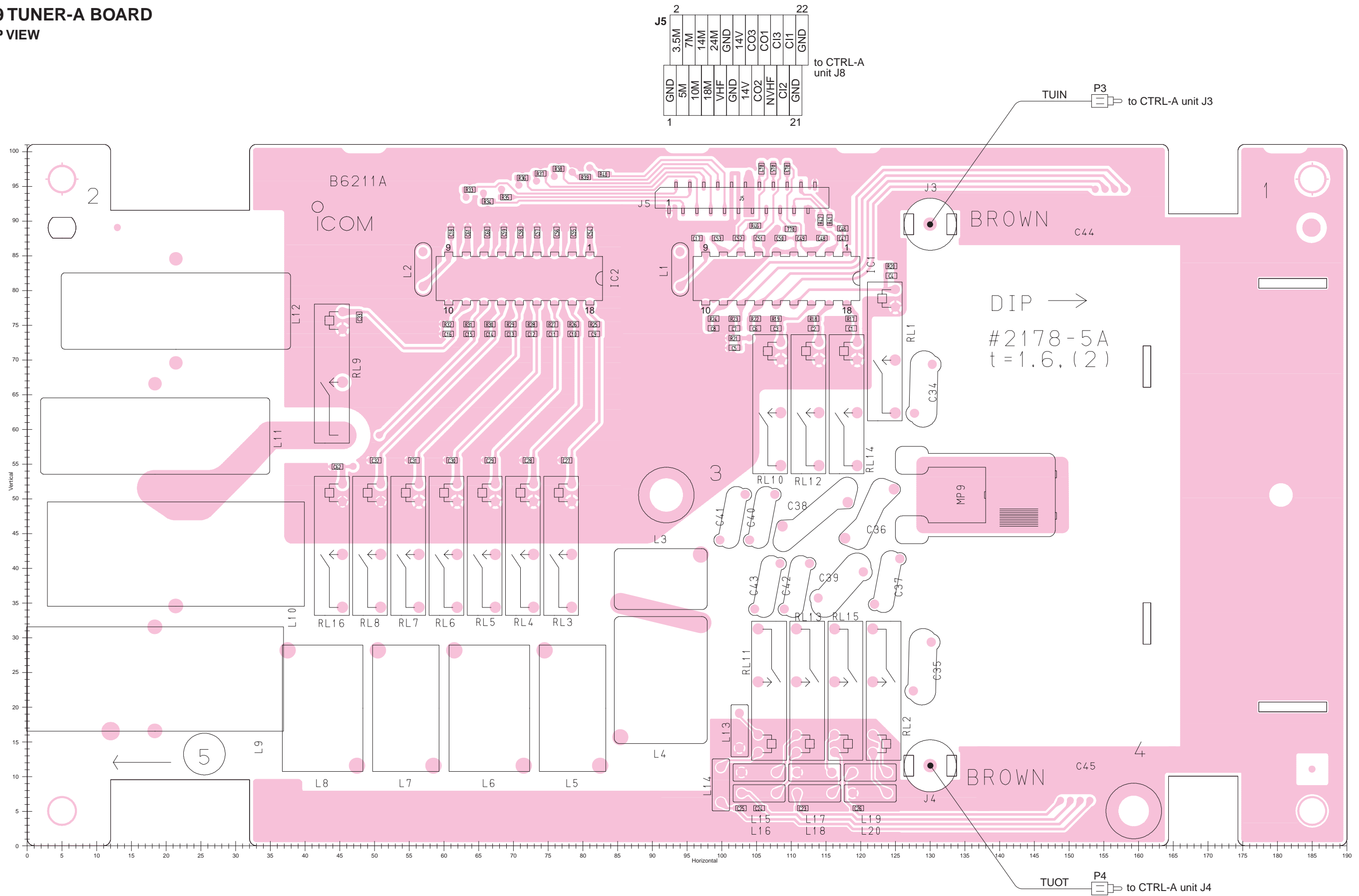

• TUNER-A BOARD (BOTTOM VIEW)

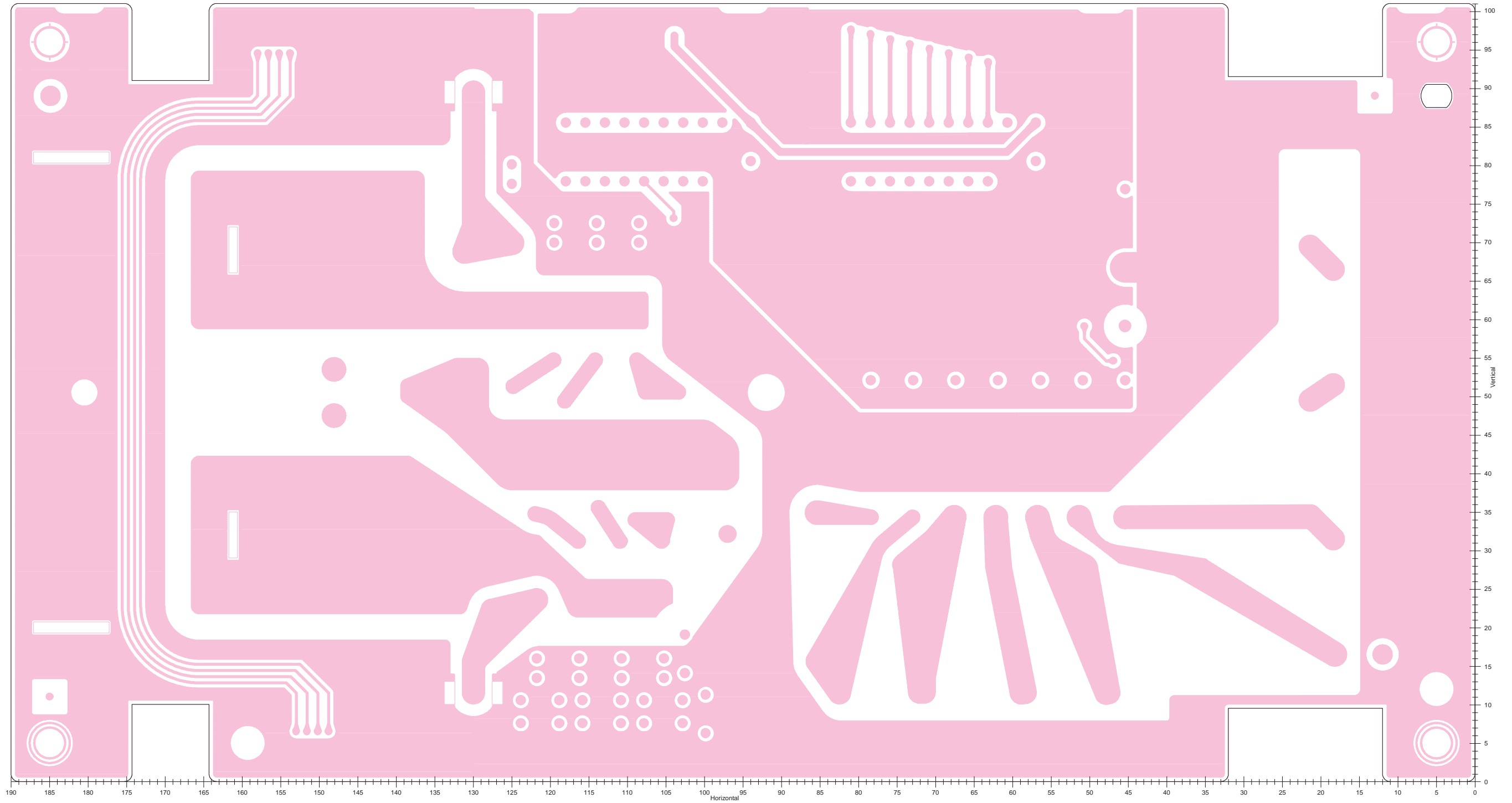

SECTION 9 BLOCK DIAGRAM

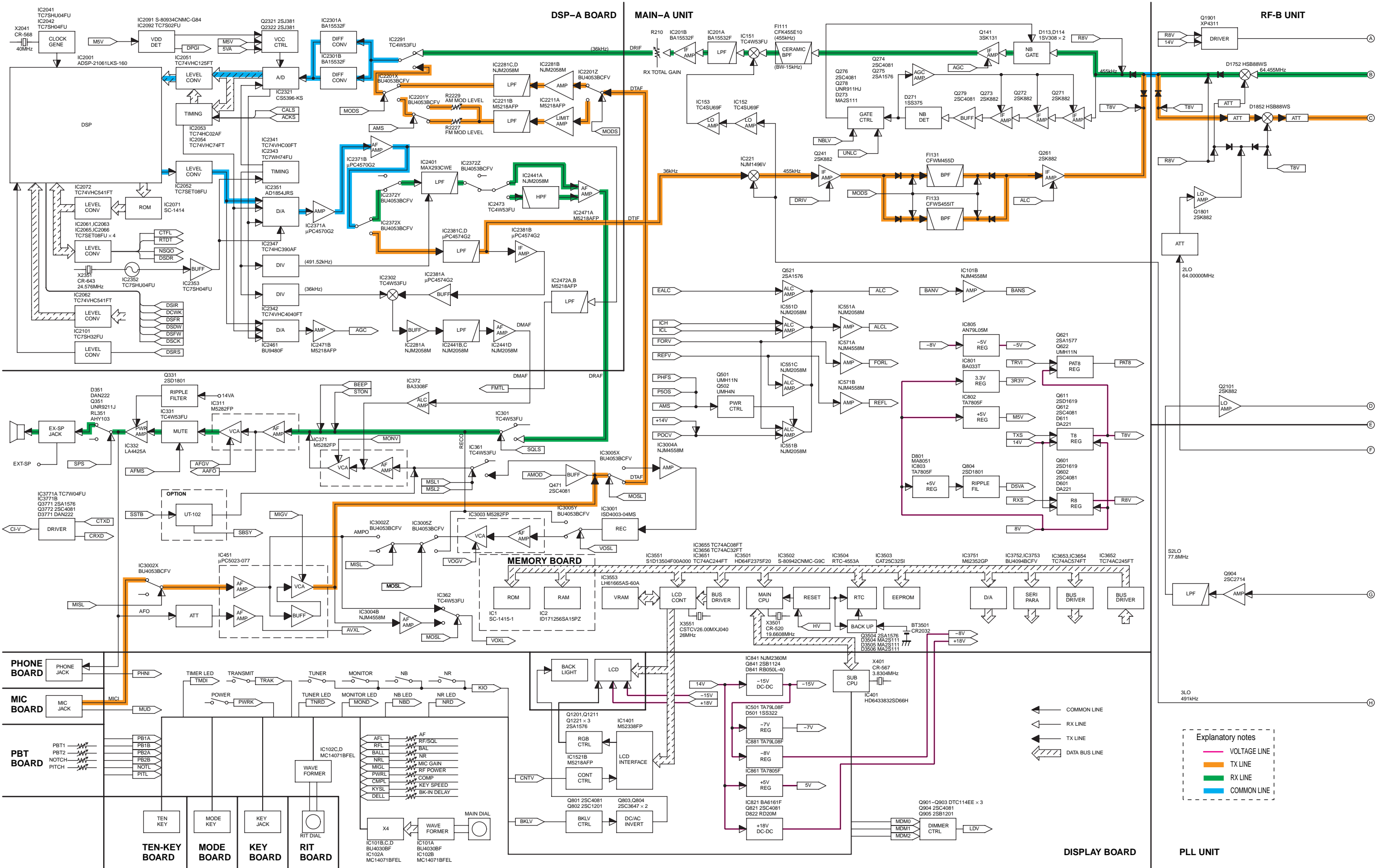

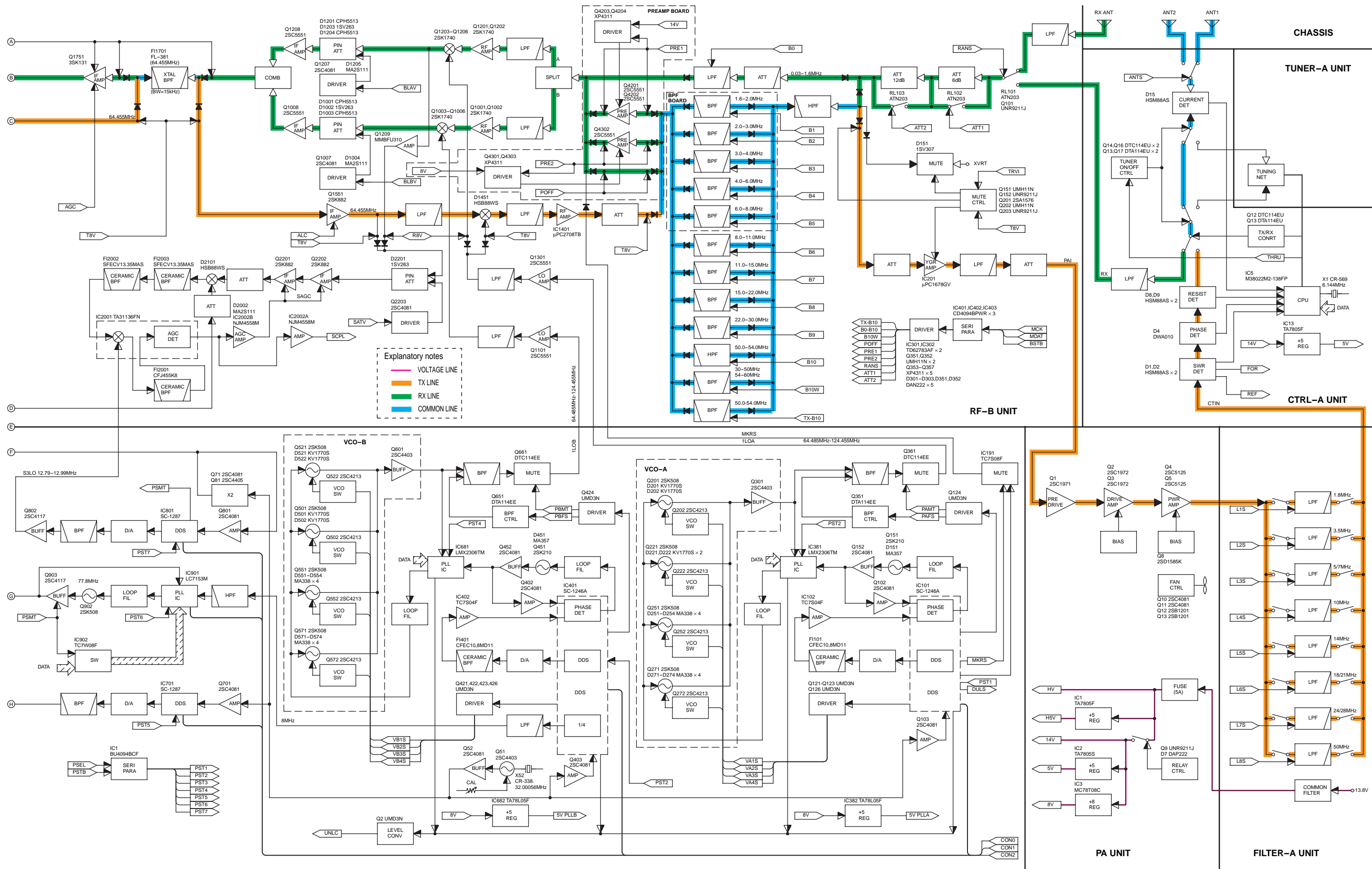

SECTION 10 VOLTAGE DIAGRAMS

10-1 FRONT UNIT

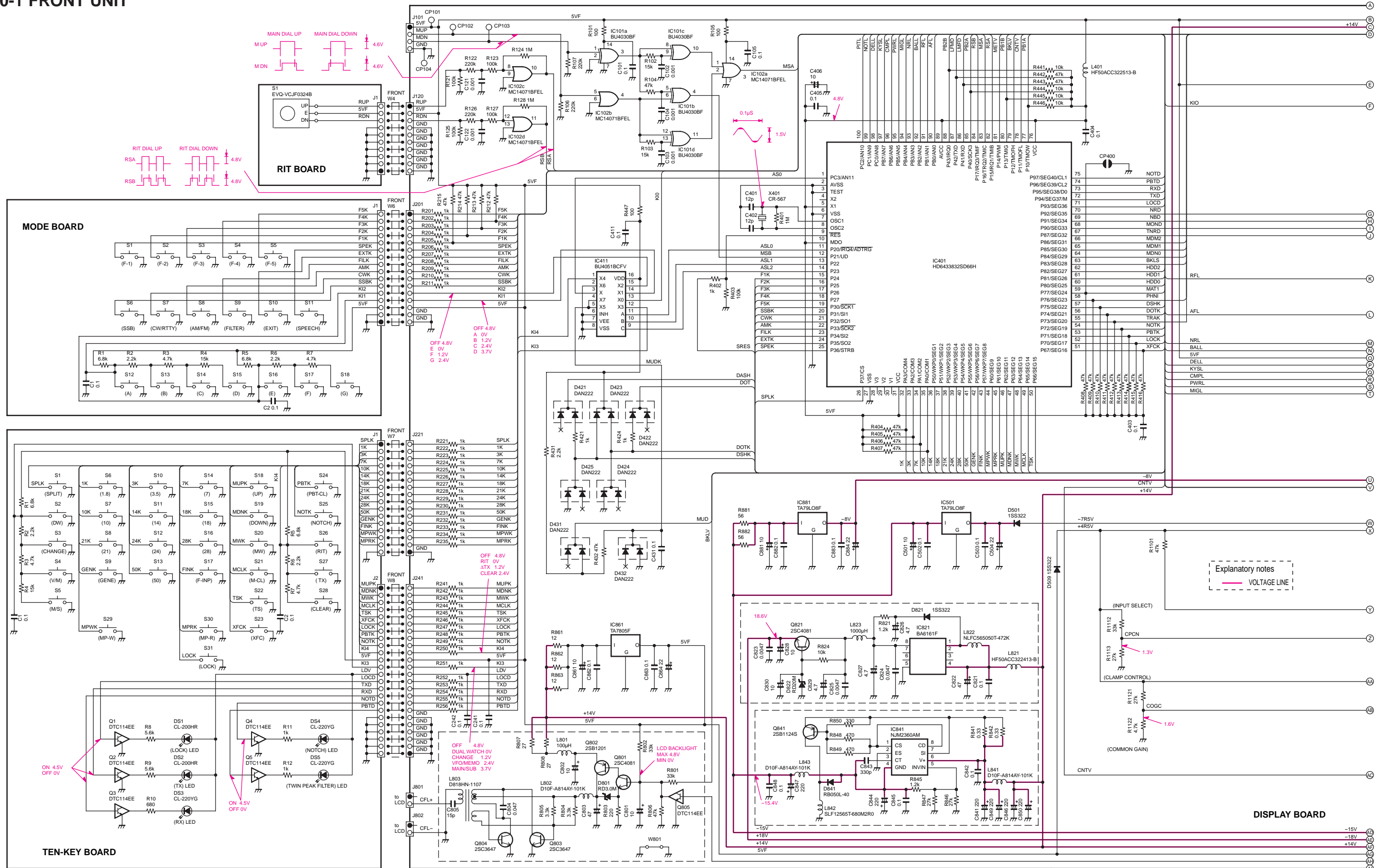

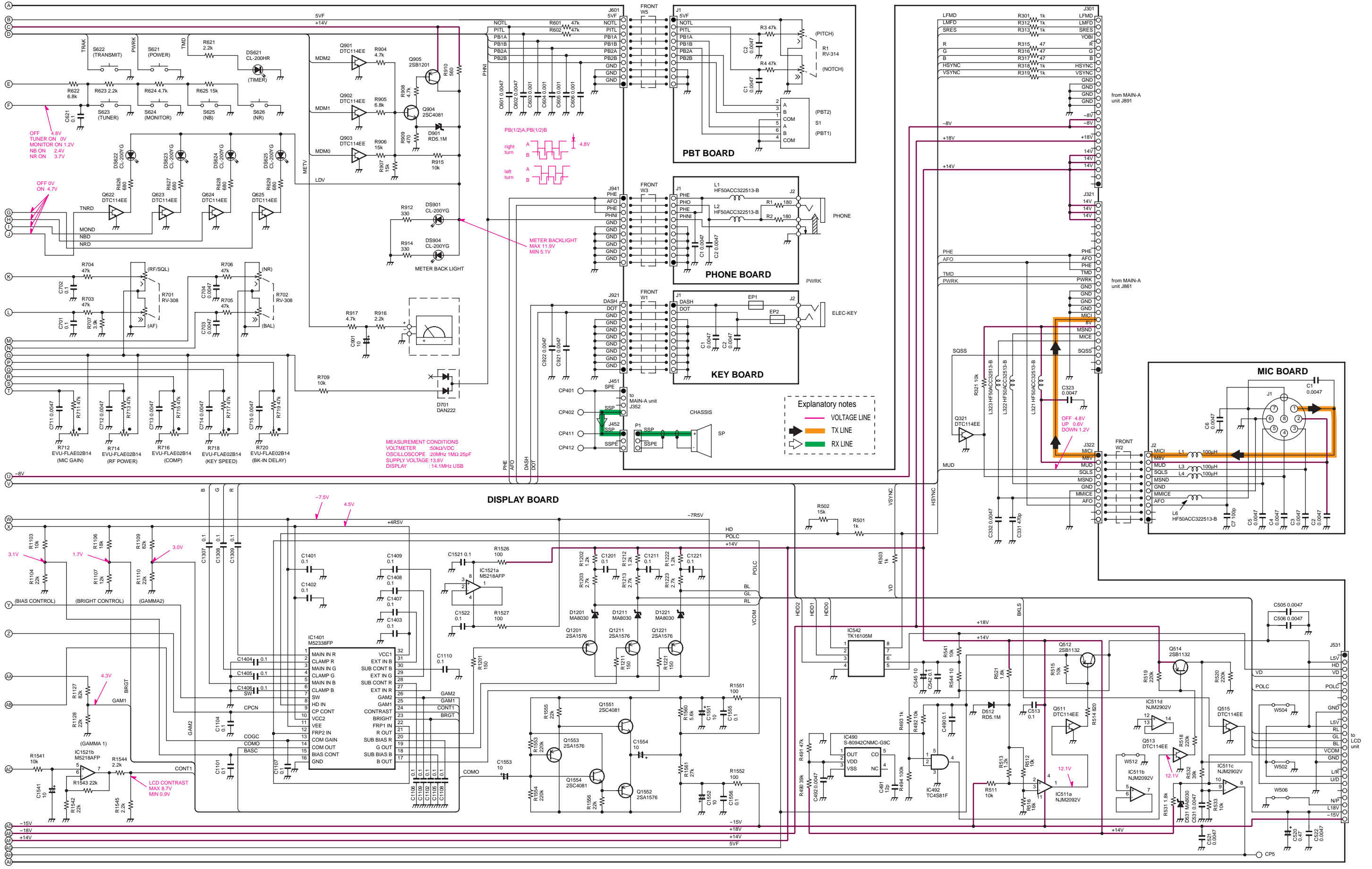

MEASUREMENT CONDITIONS
 VOLTMETER : 50kHz VDC
 OSCILLOSCOPE : 20MHz 1MΩ 25pF
 SUPPLY VOLTAGE : 13.9V
 DISPLAY : 14.1MHz USB

Explanatory notes
 — VOLTAGE LINE
 — TX LINE
 — RX LINE

LCD CONTRAST
 MAX 8.7V
 MIN 0.9V

10-2 DSP-A BOARD

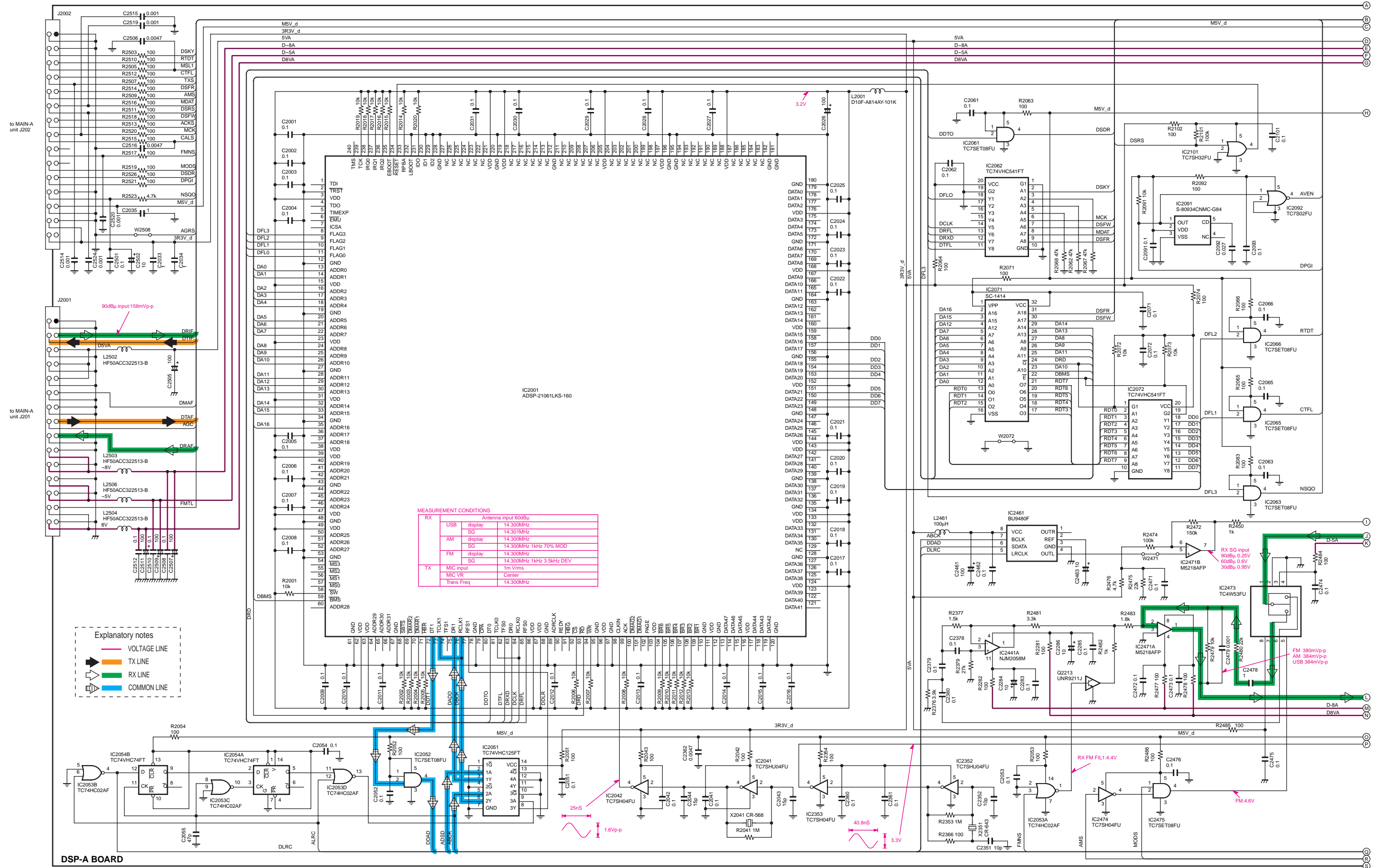

10-4 MAIN-A UNIT

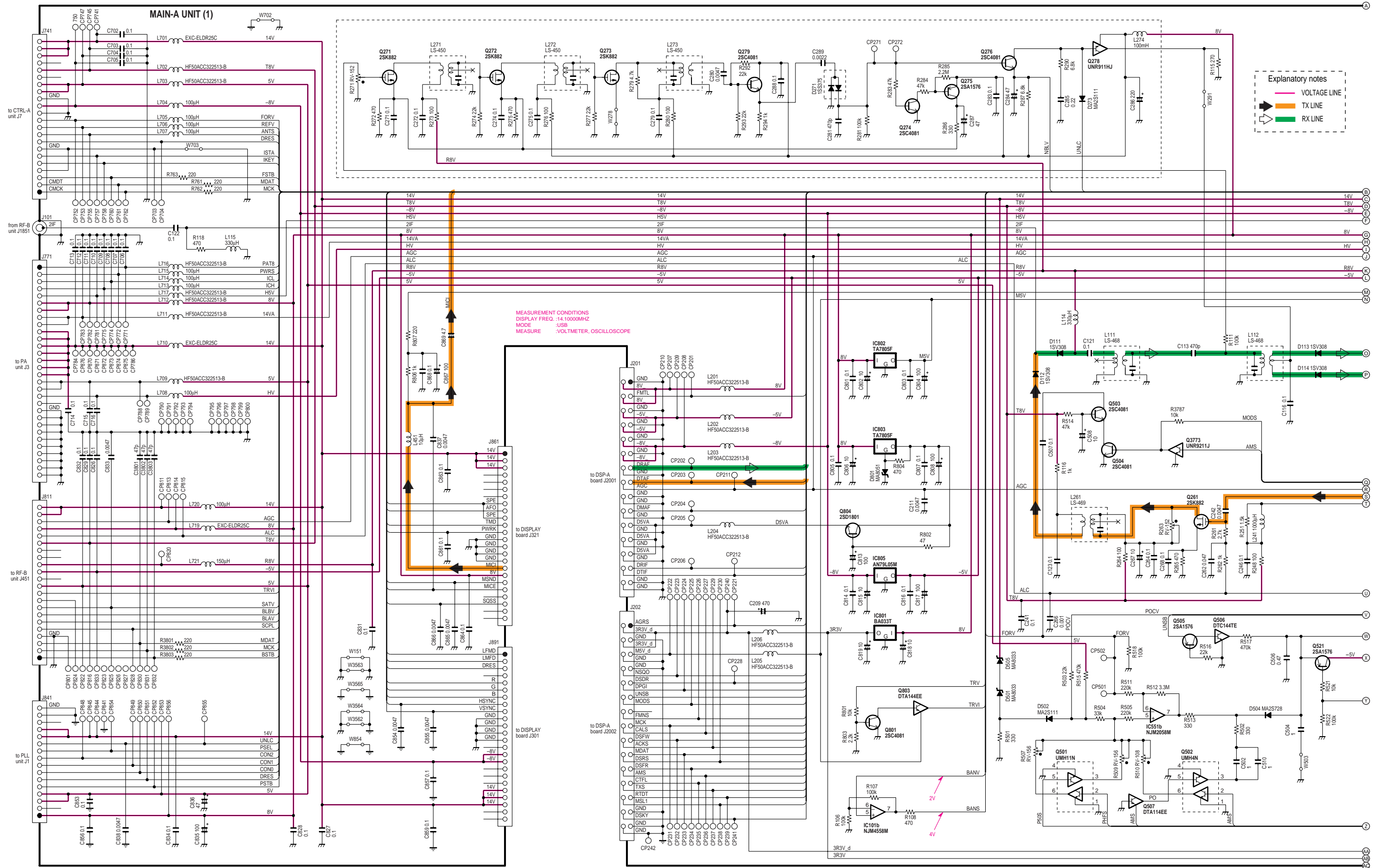

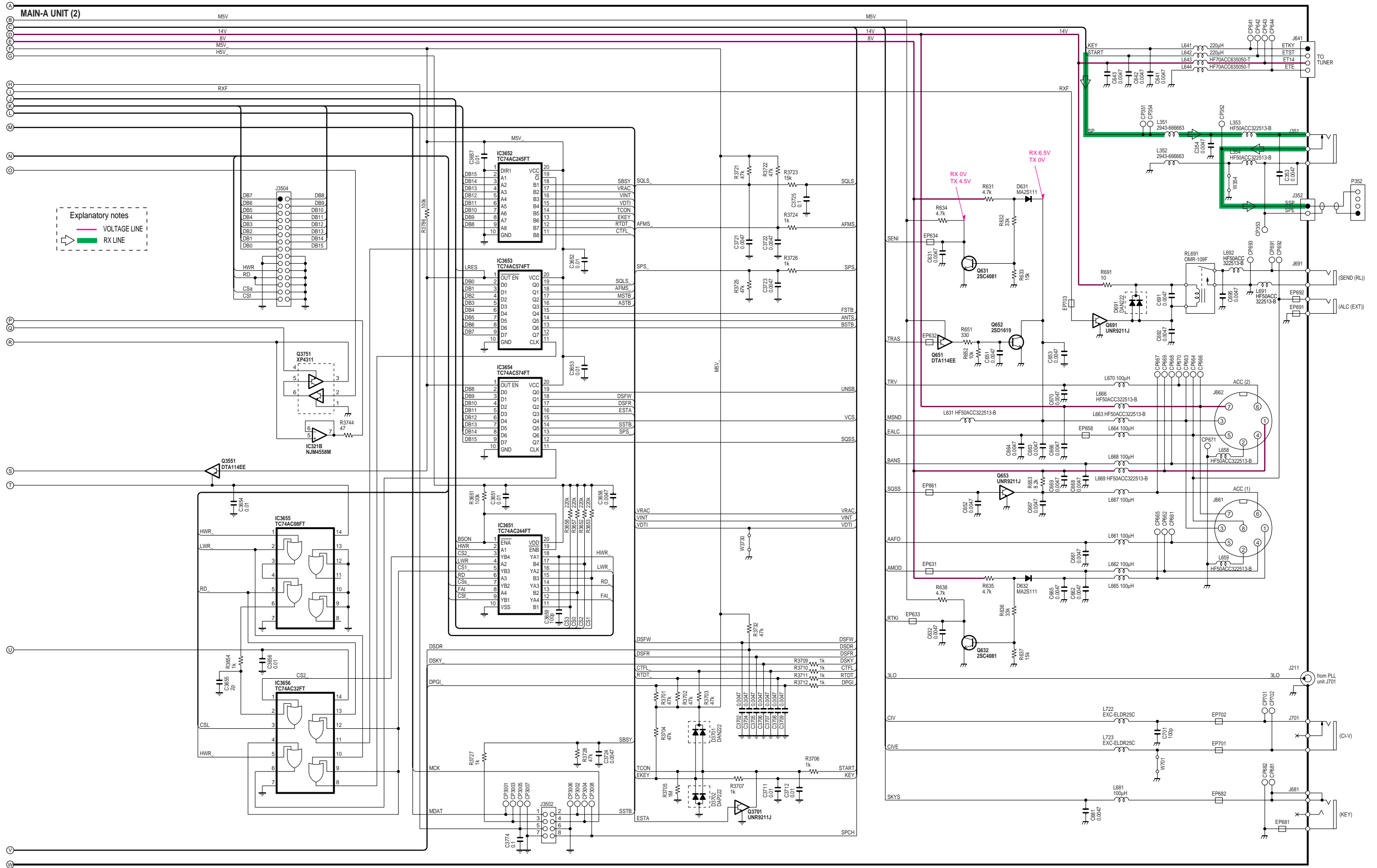

10-5 PLL UNIT

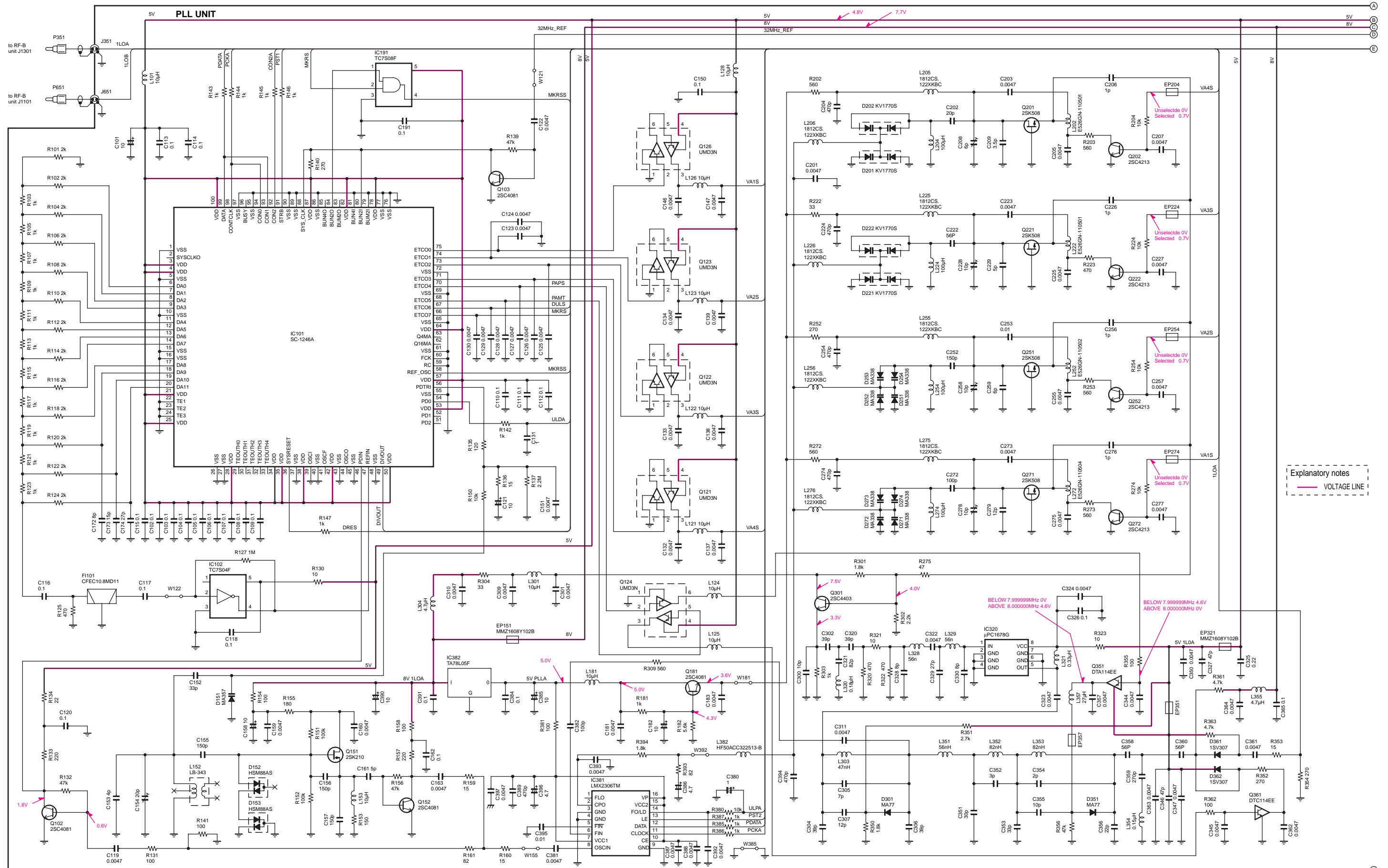

Explanatory notes
 VOLTAGE LINE

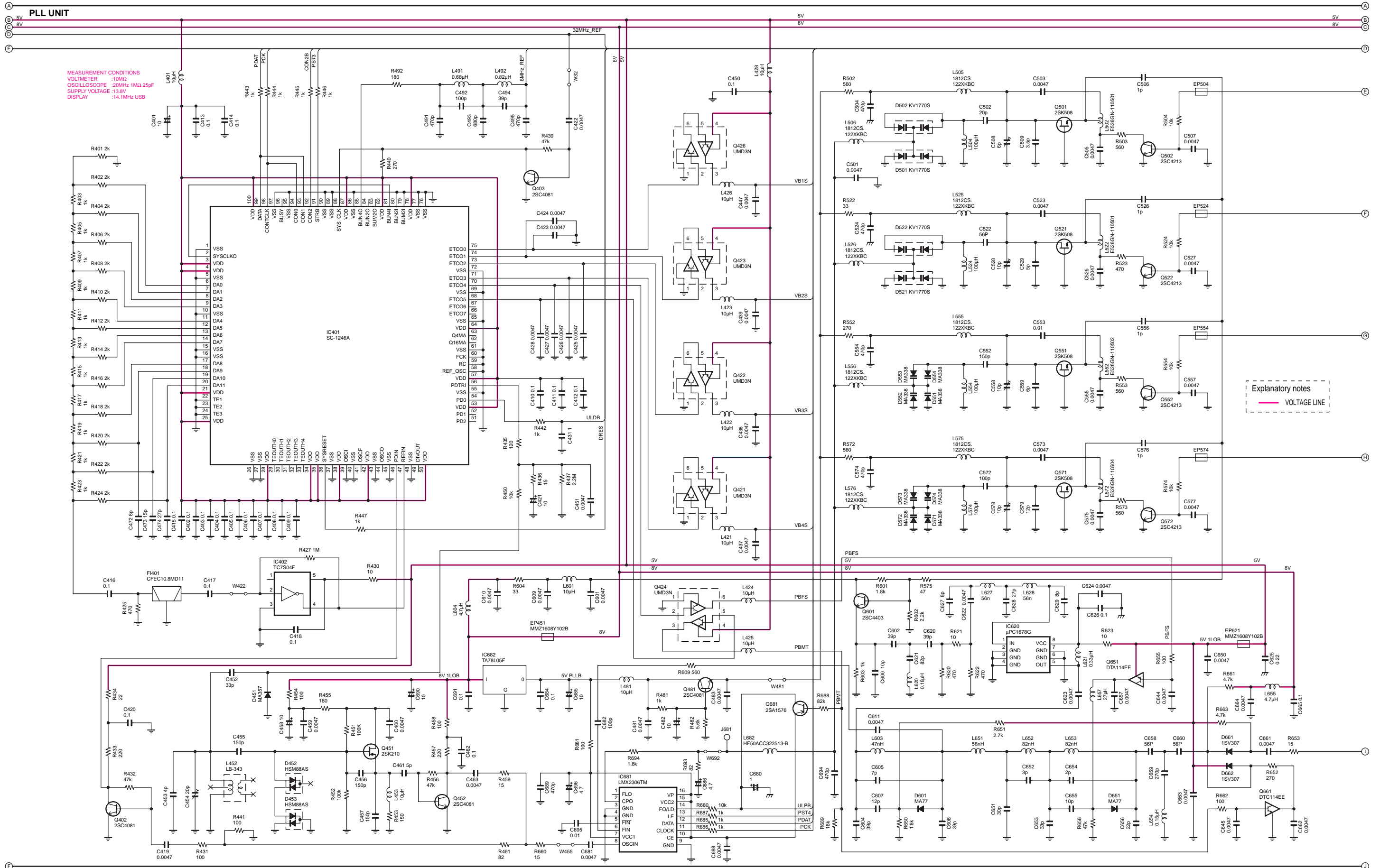

10-6 PA AND FILTER-A UNITS

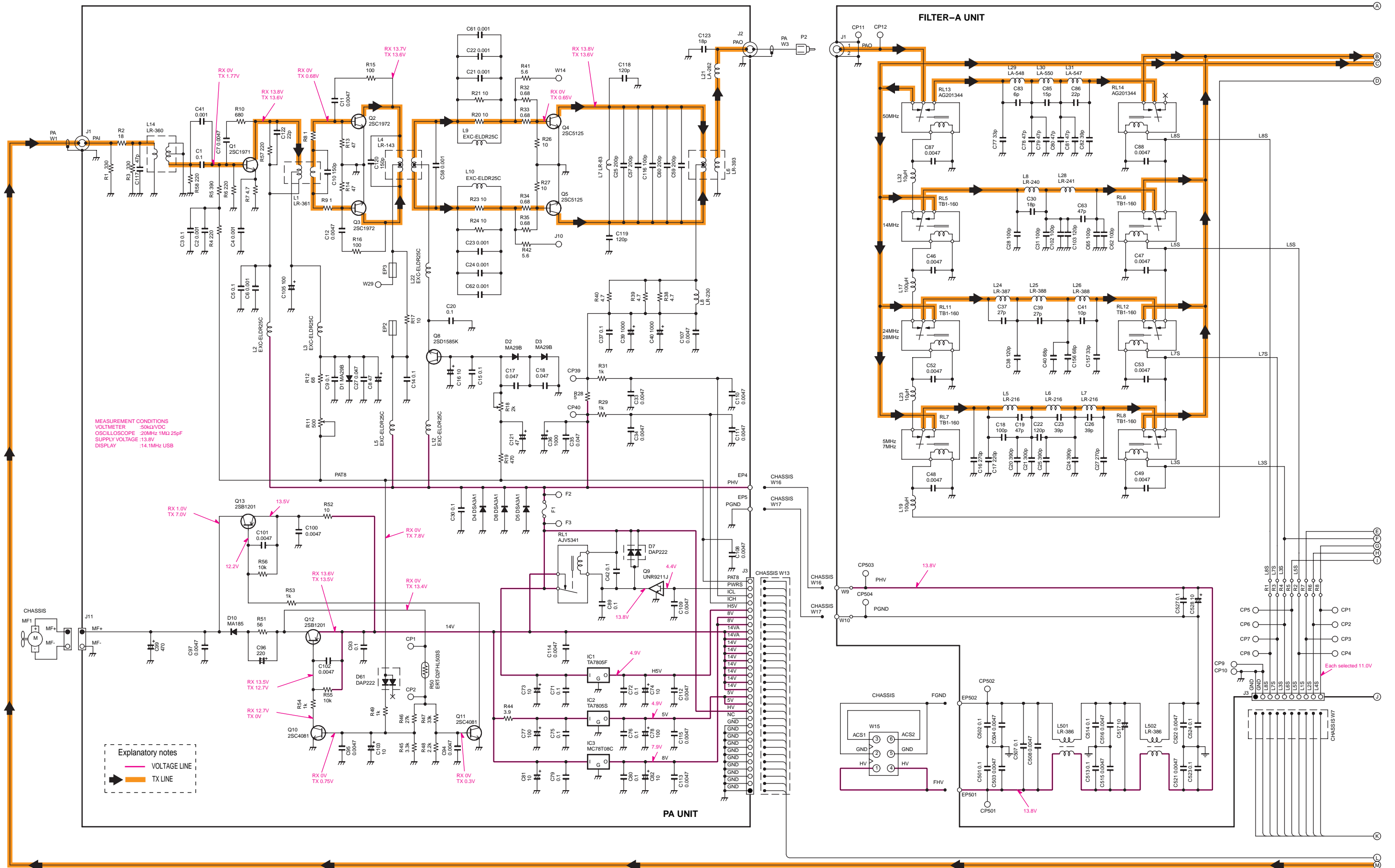

10-7 BPF-A, PREAMP BOARDS AND RF-B UNIT

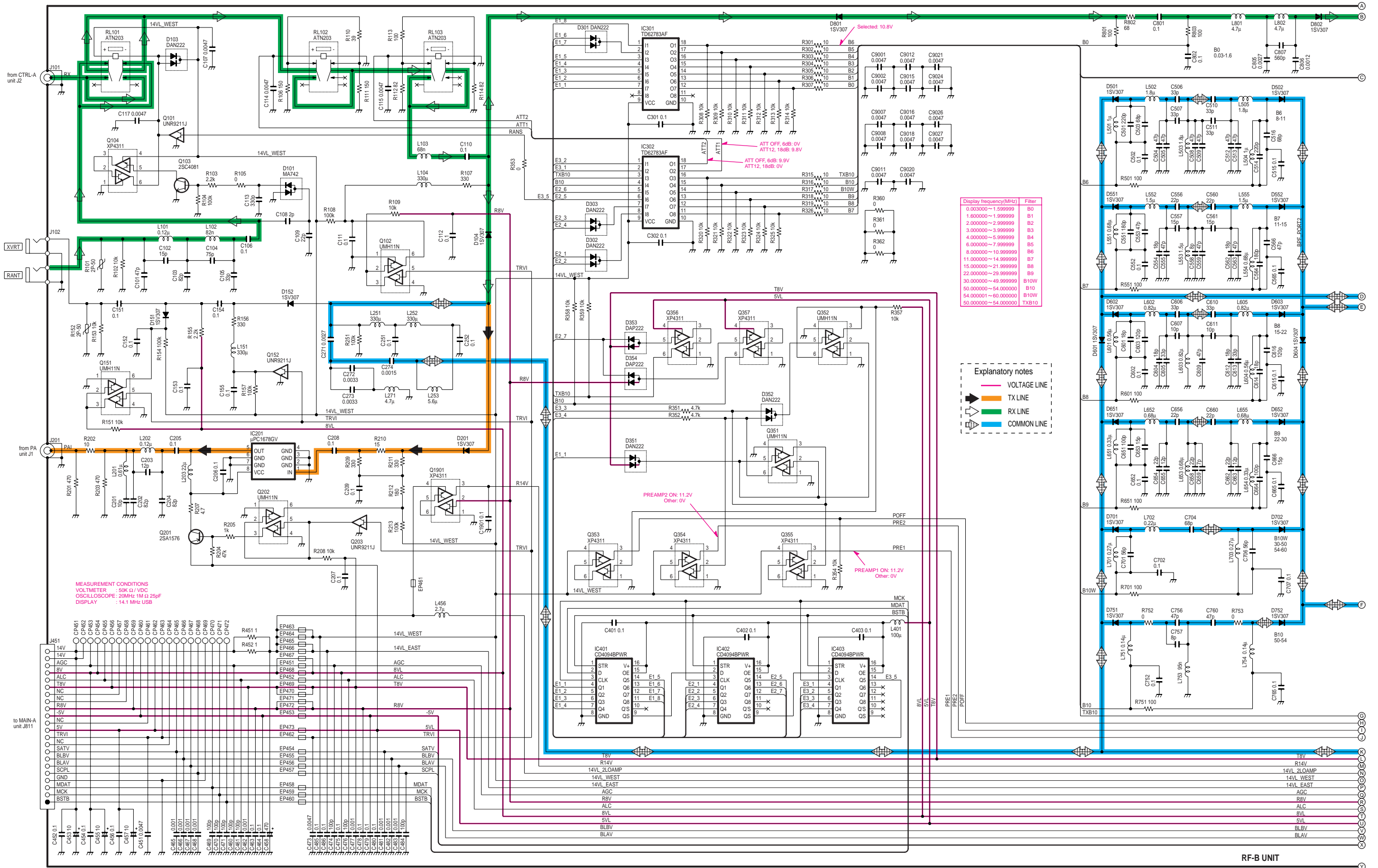

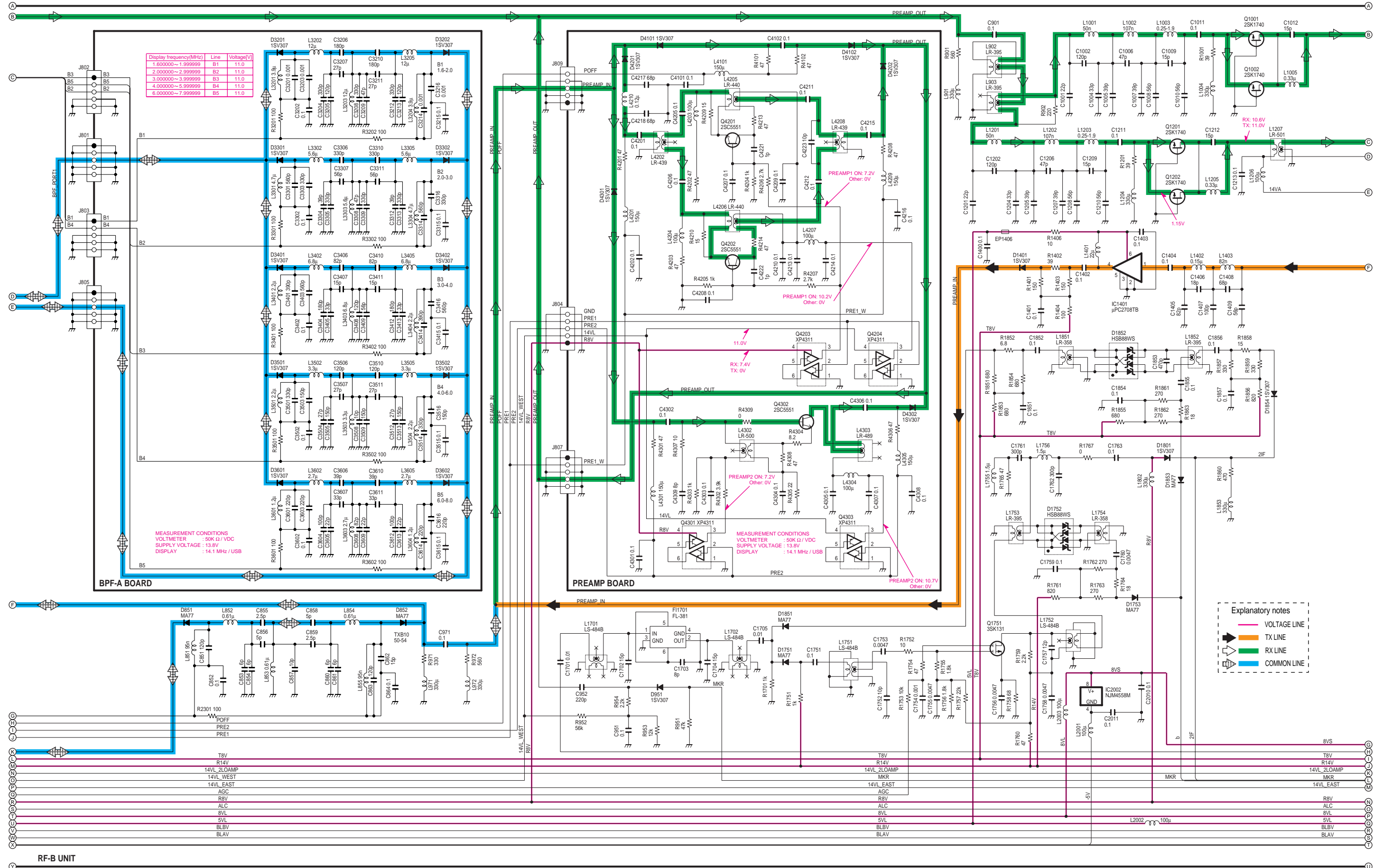

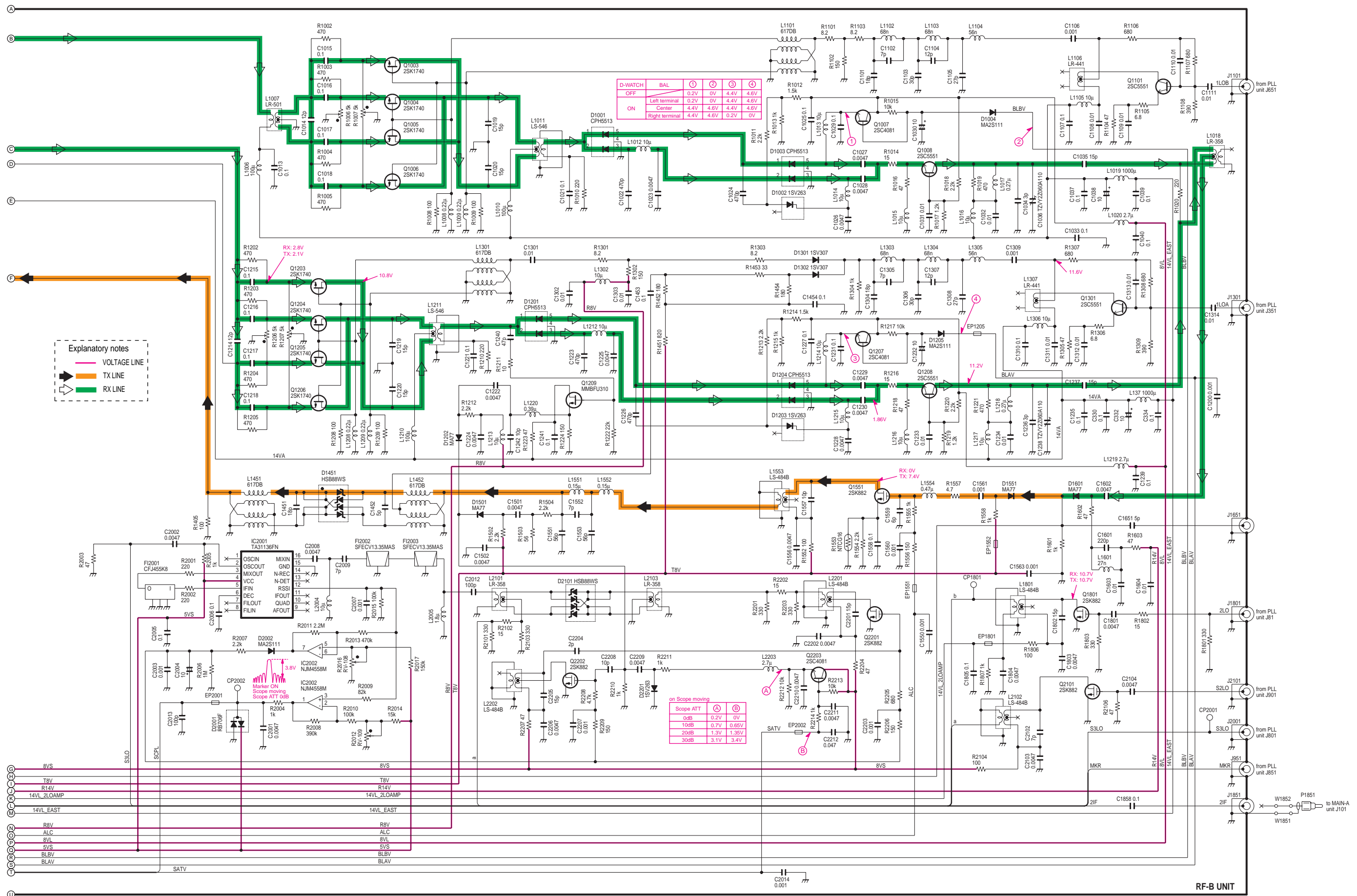

D-WATCH	BAL	①	②	③	④
OFF		0.2V	0V	4.4V	4.6V
ON	Left terminal	0.2V	0V	4.4V	4.6V
	Center	4.4V	4.6V	4.4V	4.6V
	Right terminal	4.4V	4.6V	0.2V	0V

Scope ATT	Ⓐ	Ⓑ
0dB	0.2V	0V
10dB	0.7V	0.65V
20dB	1.3V	1.35V
30dB	3.1V	3.4V

Explanatory notes

- VOLTAGE LINE
- TX LINE
- RX LINE

Icom Inc.

1-1-32, Kamiminami, Hirano-ku, Osaka 547-0003, Japan
Phone : +81 (06) 6793 5302
Fax : +81 (06) 6793 0013
URL : <http://www.icom.co.jp/world/index.html>

Icom America Inc.

<Corporate Headquarters>
2380 116th Avenue N.E., Bellevue, WA 98004, U.S.A.
Phone : +1 (425) 454-8155 Fax : +1 (425) 454-1509
URL : <http://www.icomamerica.com>
E-mail : sales@icomamerica.com
<Customer Service>
Phone : +1 (425) 454-7619

Icom Canada

Glenwood Centre #150-6165
Highway 17 Delta, B.C., V4K 5B8, Canada
Phone : +1 (604) 952-4266 Fax : +1 (604) 952-0090
URL : <http://www.icomcanada.com>
E-mail : info@icomcanada.com

Icom (Australia) Pty. Ltd.

A.B.N. 88 006 092 575
290-294 Albert Street, Brunswick, Victoria, 3056, Australia
Phone : +61 (03) 9387-0666 Fax : +61 (03) 9387-0022
URL : <http://www.icom.net.au>
E-mail : sales@icom.net.au

Icom New Zealand

146A Harris Road, East Tamaki,
Auckland, New Zealand
Phone : +64 (09) 274 4062 Fax : +64 (09) 274 4708
URL : <http://www.icom.co.nz>
E-mail : inquiries@icom.co.nz

Beijing Icom Ltd.

1305, Wanshang Plaza, Shijingshan Road, Beijing China
Phone : +86 (010) 6866 6337 Fax : +86 (010) 6866 3553
URL : <http://www.bjicom.com>
E-mail : bjicom@bjicom.com

Icom (Europe) GmbH

Communication Equipment
Himmelgeister Str. 100, D-40225 Düsseldorf, Germany
Phone : +49 (0211) 346047 Fax : +49 (0211) 333639
URL : <http://www.icomeurope.com>
E-mail : info@icomeurope.com

Icom Spain S.L

Ctra. de Gracia a Manresa Km. 14,750
08190 Sant Cugat del Valles Barcelona, SPAIN
Phone : +34 (93) 590 26 70 Fax : +34 (93) 589 04 46
URL : <http://www.icomspain.com>
E-mail : icom@icomspain.com

Icom (UK) Ltd.

Unit 9, Sea St., Herne Bay, Kent, CT6 8LD, U.K.
Phone : +44 (01227) 741741 Fax : +44 (01227) 741742
URL : <http://www.icomuk.co.uk>
E-mail : info@icomuk.co.uk

Icom France S.a

Zac de la Plaine, 1, Rue Brindejonc des Moulinais
BP 5804, 31505 Toulouse Cedex, France
Phone : +33 (5) 61 36 03 03 Fax : +33 (5) 61 36 03 00
URL : <http://www.icom-france.com>
E-mail : icom@icom-france.com

Asia Icom Inc.

6F No.68, Sec. 1 Cheng-Teh Road, Taipei, Taiwan, R.O.C.
Phone : +886 (02) 2559 1899 Fax : +886 (02) 2559 1874
URL : <http://www.asia-icom.com>
E-mail : sales@asia-icom.com

Icom Polska

Sopot, 3 Maja 54 Poland
Phone : +48 (58) 550 7135 Fax : +48 (58) 551 0484
E-mail : icompolska@icompolska.com.pl

Count on us!

Icom Inc.

1-1-32, Kamiminami, Hirano-ku, Osaka 547-0003, Japan

S-14110HZ-C1
© 2004 Icom Inc.